

OE QUALITY

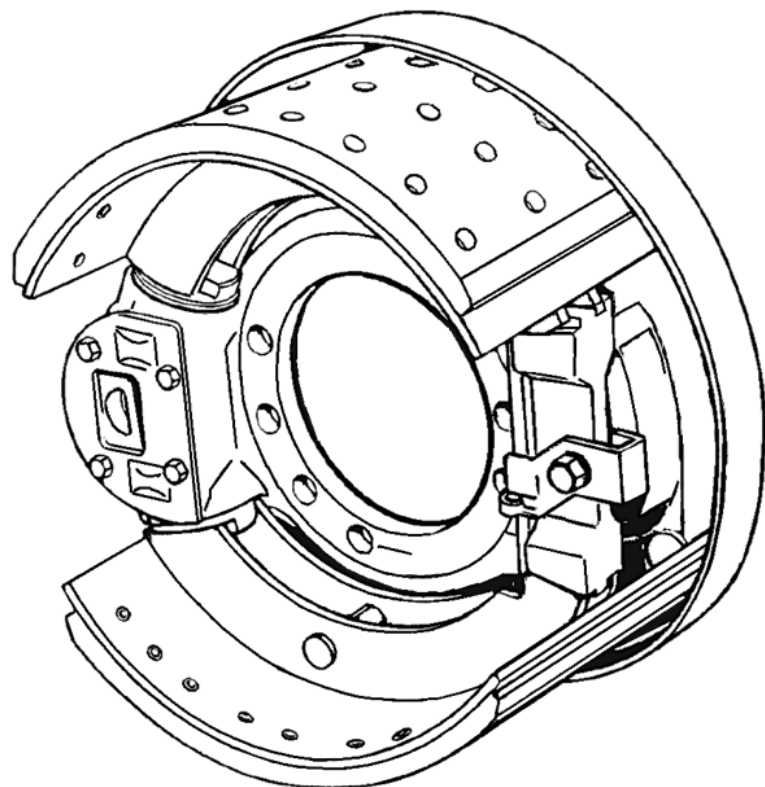

FREIN A DISQUE ET A TAMBOUR

Pages

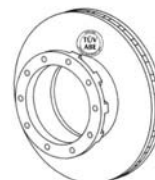

3 - 8

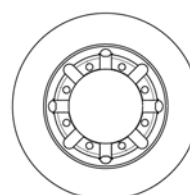

7 - 11

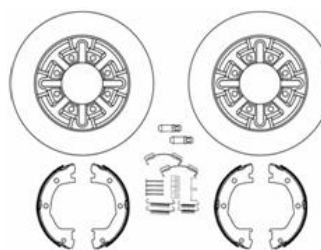
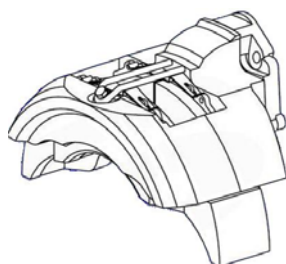

12 - 43



DON

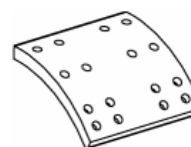
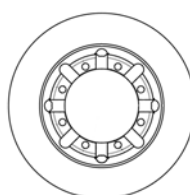

44 - 58

ROULEMENTS

TIMKEN



59 - 73

Conditions de transport & commande

74

Conditions générale de vente

75

BREMBO	Poids	DESIGNATION	REM	PRIX HT
08.3907.10	10,78	IVECO DAILY	VUL	128,00
08.3959.20	7,39	MERCEDES 207D	VUL	84,00
08.5079.10	13,58	IVECO DAILY	VUL	155,00
08.5374.10	12,68	IVECO DAILY	VUL	160,00
08.5952.10	9,77	IVECO DAILY	VUL	118,00
08.5959.10	14,78	IVECO DAILY	VUL	133,00
08.6750.10	15,69	UNIMOG SERIE U	VI	118,00
08.6750.20	15,39	UNIMOG SERIE U	VI	118,00
08.6923.20	8,96	MERCEDES T2	VUL	85,00
08.7219.10	8,57	IVECO DAILY	VUL	122,00
08.7300.10	7,07	IVECO DAILY	VUL	126,00
08.7300.20	6,97	IVECO DAILY	VUL	97,00
08.7724.10	6,54	MERCEDES -VW	VUL	91,00
08.7724.20	6,44	MERCEDES -VW	VUL	91,00
08.7725.10	7,24	MERCEDES -VW	VUL	91,00
08.7725.20	7,24	MERCEDES -VW	VUL	91,00
08.7772.10	14,80	IVECO DAILY	VUL	211,00
08.8060.10	46,00	RT	VI	280,00
08.8094.30	7,57	CITROËN-FIAT-PEUGEOT	VUL	137,00
08.8094.40	7,56	CITROËN-FIAT-PEUGEOT	VUL	137,00
08.8383.10	51,49	ROR	VI	160,00
08.8405.10	5,06	MERCEDES VITO II	VUL	95,00
08.9371.10	6,85	RENAULT MASTER II	VUL	87,00
08.9459.20	15,08	IVECO DAILY	VUL	150,00
08.9509.14	7,30	MERCEDES -VW	VUL	87,00
08.9604.14	7,76	PEUGEOT BOXER	VUL	114,00
08.9759.20	7,60	IVECO DAILY	VUL	139,00
08.9794.10	NA	RT MAXITY NISSAN ABS-	VUL	162,00
08.9794.60	NA	RT MAXITY NISSAN ABS+	VUL	190,00
08.A260.10	9,50	DAILY 2006	VUL	160,00
08.A650.10	7,70	MASTER III AR PROP.	VUL	156,00
08.A651.10	6,80	MASTER IV AR PROP.	VUL	142,00
08.B829.10	6,50	MASTER III AR TRACTION	VUL	140,00
09.3059.10	7,20	CITROËN C35	VUL	106,00
09.3111.20	14,48	IVECO ZETA	VI	202,00
09.5319.10	13,12	RENAULT R312	VI	133,00
09.5797.10	13,30	DAF-LEYLAND 45	VI	128,00
09.6732.20	14,55	RENAULT SERIE S	VI	128,00
09.6734.20	6,97	RENAULT GAMME B	VUL	79,00
09.6739.10	38,59	IVECO EUROTECH	VI	202,00
09.6739.20	38,59	IVECO EUROTECH	VI	225,00
09.6763.20	18,00	IVECO EUROCARGO	VI	123,00
09.6763.60	17,90	IVECO EUROCARGO	VI	204,00
09.6813.20	14,50	IVECO EUROCARGO	VI	102,00
09.6813.60	14,10	IVECO EUROCARGO	VI	204,00
09.6957.20	22,27	IVECO DAILY	VI	204,00
09.6959.10	6,76	FORD TRANSIT	VUL	107,00
09.6967.14	5,80	FORD TRANSIT	VUL	107,00
09.6969.10	12,00	MERCEDES 709D>814D	VI	149,00
09.6983.10	6,16	MERCEDES VITO	VUL	95,00
09.6998.10	11,10	MERCEDES 510D>711D	VI	96,00
09.7131.14	6,96	VW TRANSPORTER T4	VUL	155,00
09.7157.10	8,06	MERCEDES MB100	VUL	176,00
09.7164.10	14,40	MAN L2000	VI	118,00
09.7261.10	7,77	RENAULT MASCOTT	VUL	105,00
09.7262.10	6,97	RENAULT MASCOTT	VUL	101,00
09.7263.20	8,17	RENAULT MASCOTT	VUL	115,00

BREMBO	Poids	DESIGNATION	REM	PRIX HT
09.7263.30	8,17	NISSAN ATLEON	VI	106,00
09.7314.14	6,76	VW LT	VUL	102,00
09.7314.24	6,76	VW LT	VUL	106,00
09.7315.20	33,70	IVECO EUROCARGO	VI	328,00
09.7316.20	35,68	IVECO EUROCARGO	VI	328,00
09.7320.10	36,49	MAN F2000, L,M	VI	234,00
09.7322.10	13,60	VOLVO GAMME FL	VI	139,00
09.7322.20	13,60	VOLVO GAMME FL	VI	139,00
09.7323.10	15,40	DAF-LEYLAND 45 NG	VI	139,00
09.7380.30	34,79	BPW AXLE	VI	212,00
09.7381.20	37,49	MAN F90	VI	266,00
09.7382.20	35,99	MAN F90	VI	266,00
09.7383.20	39,69	BPW SH SERIES	VI	212,00
09.7717.10	7,68	RENAULT MASTER II	VUL	106,00
09.7723.10	7,96	IVECO DAILY	VUL	96,00
09.7804.60	23,28	IVECO EUROCARGO	VI	164,00
09.7873.10	18,40	IVECO BUS	VI	685,00
09.7929.30	34,60	IVECO EUROCARGO	VI	286,00
09.7929.90	34,40	IVECO EUROCARGO	VI	296,00
09.7956.10	24,40	RENAULT FR1	VI	212,00
09.7957.10	31,49	ROR LMC	VI	160,00
09.8059.20	NA	RENAULT MAGNUM	VI	261,00
09.8128.10	33,79	EOBUS SERIE S	VI	278,00
09.8129.10	34,29	MERCEDES O404	VI	308,00
09.8129.20	34,29	EOBUS SERIE S	VI	308,00
09.8172.10	16,78	MAN L2000	VI	144,00
09.8173.10	17,00	MAN L2000	VI	144,00
09.8205.10	12,70	MERCEDES VARIO	VI	107,00
09.8206.10	12,10	MERCEDES VARIO	VI	107,00
09.8367.10	28,19	SAF SK RS-SK RZ	VI	153,00
09.8368.10	41,99	SAF SK RS-SK RZ	VI	153,00
09.8404.10	8,66	MERCEDES VITO II	VUL	105,00
09.8472.10	38,19	BPW SH SERIES	VI	181,00
09.8475.10	7,58	MERCEDES SPRINTER	VUL	91,00
09.8486.20	33,49	BPW SH SERIES	VI	160,00
09.8495.10	14,90	NISSAN ATLEON	VI	233,00
09.8526.10	38,09	SMB D1/H1/K1	VI	153,00
09.8543.10	28,00	SMB K5	VI	153,00
09.8556.10	26,39	SAF SK RB 9019	VI	160,00
09.8573.10	24,70	MERCEDES ATEGO	VI	202,00
09.8574.10	15,50	MERCEDES ATEGO	VI	181,00
09.8579.10	33,00	VOLVO FH	VI	234,00
09.8634.10	7,27	NISSAN ATLEON	VI	176,00
09.8793.10	34,59	SAF SK RB 9022	VI	160,00
09.8837.14	7,46	FORD TRANSIT	VUL	118,00
09.8925.10	26,99	MERCEDES ATEGO	VI	160,00
09.8931.10	7,48	CITROËN JUMPER	VUL	99,00
09.8932.10	8,28	CITROËN JUMPER	VUL	104,00
09.8937.10	9,89	RENAULT TRAFIC II	VUL	118,00
09.8960.10	6,75	FORD TRANSIT	VUL	106,00
09.8965.10	8,36	RT MAXITY NISSAN	VUL	106,00
09.8979.10	NA	ROR	VI	171,00
09.9080.10	10,36	RENAULT MASTER II	VUL	105,00
09.9181.10	16,08	MERCEDES ATEGO	VI	113,00
09.9182.10	15,08	MERCEDES ATEGO	VI	153,00
09.9301.10	36,39	MAN F90	VI	239,00
09.9354.10	23,99	DAF LF 55	VI	212,00

BREMBO	Poids	DESIGNATION	OBS	REM	PRIX HT
20.2802.96	NA	ETRIER BREMBO P75B DOT4		VI	640,00
20.2846.11	NA	ETRIER BREMBO P60A DOT4		VI	370,00
20.2846.31	NA	ETRIER BREMBO GAUCHE P60A (LHM)		VI	370,00
20.3195.31	NA	ETRIER BREMBO P 2.48 LHM		VI	370,00
507.4146.48	2,000	PLAQUETTES FRE IVECO	29041	VI	61,00
507.4146.49	NA	PLAQUETTES FRE IVECO	29037	VI	76,00
507.4146.51	2,000	PLAQUETTES FRE IVECO	21188	VI	76,00
507.4146.59	NA	PLAQUETTES FRE IVECO	29075	VI	383,00
507.4146.61	NA	PLAQUETTES FRE IVECO	21188	VI	76,00
507.4146.85	NA	PLAQUETTES FRE IVECO	29140	VI	72,00
507.4146.86	NA	PLAQUETTES FRE IVECO	29037	VI	70,00
507.4146.87	NA	PLAQUETTES FRE IVECO	29012; 29138	VI	110,00
507.4656.05	0,080	TEMOINS USURE IVECO	LONG : 210 mm	VI	34,00
507.4656.94	0,080	TEMOINS USURE IVECO	LONG : 300 mm	VI	33,00
507.5664.31	4,540	PLAQUETTES FREIN IVECO	29067	VI	139,00
507.5901.21	4,160	PLAQUETTES FREIN IVECO	29122	VI	131,00
507.5901.30	4,300	PLAQUETTES FREIN IVECO	29122	VI	231,00
507.5944.11	2,500	PLAQUETTES FREIN IVECO	29121	VI	74,00
507.5944.19	2,581	PLAQUETTES FREIN IVECO	29121	VI	112,00
507.5944.32	2,260	PLAQUETTES FREIN RT	29121	VI	72,00
507.5944.54	2,600	PLAQUETTES FREIN NISSAN	29121	VI	112,00
507.7186.10	NA	PLAQUETTES FREIN IVECO	29186	VI	465,00
507.7186.30	NA	PLAQUETTES FREIN IVECO	29186	VI	454,00
507.7273.12	1,800	PLAQUETTES FREIN IVECO	29123	VI	76,00
507.7273.16	1,860	PLAQUETTES FREIN IVECO	29123	VI	90,00
507.7304.18	2,760	PLAQUETTES FREIN RT	29160; 29237	VI	173,00
507.7304.25	2,900	PLAQUETTES FREIN NISSAN	29160	VI	197,00
507.8156.42	1,640	PLAQUETTES FREIN RT NISSAN	23921	VI	170,00
507.9308.50	0,080	TEMOINS USURE IVECO		VI	32,00
507.9308.53	0,100	TEMOINS USURE IVECO		VI	43,00
507.9308.62	0,080	TEMOINS USURE IVECO		VI	26,00
507.9308.63	0,080	TEMOINS USURE IVECO		VI	41,00
507.9308.66	0,080	TEMOINS USURE IVECO		VI	36,00
507.9703.10	2,900	PLAQUETTES FREIN IVECO	29229	VI	164,00
507.9703.16	2,880	PLAQUETTES FREIN RT NISSAN	29229	VI	181,00
507.9724.10	2,760	PLAQUETTES FREIN IVECO	29232	VI	167,00
507.9786.10	3,300	PLAQUETTES FREIN IVECO	29231	VI	238,00
507.9814.11	5,600	PLAQUETTES FREIN IVECO	29256	VI	160,00
507.9814.21	2,880	PLAQUETTES FREIN IVECO	29256	VI	160,00
520.4910.82	7,740	ETRIER GAUCHE IVECO	BREMBO P 4.42	VI	250,00
520.4910.82C	NA	CONSIGNE ETRIER		NET	20,00
520.4910.83	7,740	ETRIER DROIT IVECO	BREMBO P 4.42	VI	250,00
520.4910.83C	NA	CONSIGNE ETRIER		NET	20,00
520.4910.84	6,470	ETRIER GAUCHE IVECO	BREMBO P 4.42	VI	494,00
520.4910.84C	NA	CONSIGNE ETRIER		NET	20,00
520.4910.85	6,740	ETRIER DROIT IVECO	BREMBO P 4.42	VI	494,00
520.4910.85C	NA	CONSIGNE ETRIER		NET	20,00
520.5150.11	7,750	ETRIER GAUCHE IVECO	BREMBO P 4.44	VI	486,00
520.5150.11C	NA	CONSIGNE ETRIER		NET	20,00
520.5150.21	7,750	ETRIER DROIT IVECO	BREMBO P 4.44	VI	486,00
520.5150.21C	NA	CONSIGNE ETRIER		NET	20,00
520.5310.10	31,820	ETRIER BIDISC		VI	1 571,00
520.5310.10C	NA	CONSIGNE ETRIER		NET	100,00
520.5320.12	31,300	ETRIER BIDISC GAUCHE R312		VI	2 161,00
520.5320.12C	NA	CONSIGNE ETRIER		NET	100,00
520.5320.22	31,300	ETRIER BIDISC DROIT R312		VI	2 161,00

BREMBO	Poids	DESIGNATION	OBS	REM	PRIX HT
520.5320.22C		NA CONSIGNE ETRIER		NET	100,00
520.5320.32	31,300	ETRIER BIDISC GAUCHE R312		VI	2 161,00
520.5320.32C		NA CONSIGNE ETRIER		NET	100,00
520.5320.42	31,300	ETRIER BIDISC DROIT R312		VI	2 161,00
520.5320.42C		NA CONSIGNE ETRIER		NET	100,00
520.5360.12	31,200	ETRIER BIDISC GAUCHE		VI	1 739,00
520.5360.12C		NA CONSIGNE ETRIER		NET	100,00
520.5360.22	31,200	ETRIER BIDISC DROIT		VI	1 739,00
520.5360.22C		NA CONSIGNE ETRIER		NET	100,00
520.9576.10		NA ETRIER GAUCHE IVECO	BREMBO P 4.50	VI	684,00
520.9576.10C		NA CONSIGNE ETRIER		NET	100,00
520.9576.20		NA ETRIER DROIT IVECO	BREMBO P 4.50	VI	684,00
520.9576.20C		NA CONSIGNE ETRIER		NET	100,00
522.5000.27	0,360	JEU COLONETTE ETRIER IVECO		VI	82,00
522.5660.08	15,780	ETRIER GAUCHE IVECO	BREMBO PF 2.68	VI	450,00
522.5660.08C		NA CONSIGNE ETRIER		NET	50,00
522.5660.09	15,780	ETRIER DROIT IVECO	BREMBO PF 2.68	VI	450,00
522.5660.09C		NA CONSIGNE ETRIER		NET	50,00
522.5670.08	20,180	ETRIER GAUCHE IVECO	BREMBO PFC 2.68	VI	760,00
522.5670.08C		NA CONSIGNE ETRIER		NET	50,00
522.5670.09	20,180	ETRIER DROIT IVECO	BREMBO PFC 2.68	VI	760,00
522.5670.09C		NA CONSIGNE ETRIER		NET	50,00
522.5670.74	20,180	ETRIER GAUCHE NISSAN	BREMBO PFC 2.68	VI	900,00
522.5670.74C		NA CONSIGNE ETRIER		NET	50,00
522.5670.84	20,180	ETRIER DROIT NISSAN	BREMBO PFC 2.68	VI	900,00
522.5670.84C		NA CONSIGNE ETRIER		NET	50,00
522.5760.08	15,420	ETRIER GAUCHE IVECO	BREMBO PF 2.60	VI	404,00
522.5760.08C		NA CONSIGNE ETRIER		NET	50,00
522.5760.09	15,500	ETRIER DROIT IVECO	BREMBO PF 2.60	VI	404,00
522.5760.09C		NA CONSIGNE ETRIER		NET	50,00
522.5770.16	19,300	ETRIER GAUCHE IVECO	BREMBO PFC 2.60	VI	536,00
522.5770.16C		NA CONSIGNE ETRIER		NET	50,00
522.5770.26	19,300	ETRIER DROIT IVECO	BREMBO PFC 2.60	VI	536,00
522.5770.26C		NA CONSIGNE ETRIER		NET	50,00
522.7220.01	7,650	ETRIER GAUCHE IVECO	BREMBO PF 2.42	VI	324,00
522.7220.01C		NA CONSIGNE ETRIER		NET	50,00
522.7220.02	7,650	ETRIER DROIT IVECO	BREMBO PF 2.42	VI	324,00
522.7220.02C		NA CONSIGNE ETRIER		NET	50,00
522.7270.52	6,980	ETRIER GAUCHE IVECO	BREMBO PFC 1.52	VI	338,00
522.7270.52C		NA CONSIGNE ETRIER		NET	20,00
522.7270.62	6,980	ETRIER DROIT IVECO	BREMBO PFC 1.52	VI	338,00
522.7270.62C		NA CONSIGNE ETRIER		NET	20,00
522.7301.28	9,280	ETRIER GAUCHE IVECO	BREMBO PF 2.52	VI	458,00
522.7301.28C		NA CONSIGNE ETRIER		NET	20,00
522.7301.29	9,280	ETRIER DROIT IVECO	BREMBO PF 2.52	VI	458,00
522.7301.29C		NA CONSIGNE ETRIER		NET	20,00
522.7301.50	9,280	ETRIER GAUCHE DB	BREMBO PF 2.52	VI	460,00
522.7301.50C		NA CONSIGNE ETRIER		NET	20,00
522.7301.60	9,280	ETRIER DROIT DB	BREMBO PF 2.52	VI	460,00
522.7301.60C		NA CONSIGNE ETRIER		NET	20,00
522.7301.73	9,280	ETRIER GAUCHE RT	BREMBO PF 2.52	VI	460,00
522.7301.73C		NA CONSIGNE ETRIER		NET	20,00
522.7301.74	9,280	ETRIER GAUCHE NISSAN	BREMBO PF 2.52	VI	598,00
522.7301.74C		NA CONSIGNE ETRIER		NET	20,00
522.7301.83	9,280	ETRIER DROIT RT	BREMBO PF 2.52	VI	460,00
522.7301.83C		NA CONSIGNE ETRIER		NET	20,00

BREMBO	Poids	DESIGNATION	OBS	REM	PRIX HT
522.7301.84	9,280	ETRIER DROIT NISSAN	BREMBO PF 2.52	VI	598,00
522.7301.84C	NA	CONSIGNE ETRIER		NET	20,00
522.7306.28	7,300	ETRIER GAUCHE RT	BREMBO PF 2.46	VI	294,00
522.7306.28C	NA	CONSIGNE ETRIER		NET	20,00
522.7306.29	7,340	ETRIER DROIT RT	BREMBO PF 2.46	VI	294,00
522.7306.29C	NA	CONSIGNE ETRIER		NET	20,00
522.7773.28	7,910	ETRIER GAUCHE IVECO	BREMBO PF 2.44	VI	280,00
522.7773.28C	NA	CONSIGNE ETRIER		NET	20,00
522.7773.29	7,910	ETRIER DROIT IVECO	BREMBO PF 2.44	VI	280,00
522.7773.29C	NA	CONSIGNE ETRIER		NET	20,00
522.7773.73	7,110	ETRIER GAUCHE RT	BREMBO PF 2.44	VI	228,00
522.7773.73C	NA	CONSIGNE ETRIER		NET	20,00
522.7773.83	7,110	ETRIER DROIT RT	BREMBO PF 2.44	VI	228,00
522.7773.83C	NA	CONSIGNE ETRIER		NET	20,00
522.7775.28	8,700	ETRIER GAUCHE IVECO	BREMBO PF 2.44	VI	368,00
522.7775.28C	NA	CONSIGNE ETRIER		NET	20,00
522.7775.29	8,700	ETRIER DROIT IVECO	BREMBO PF 2.44	VI	368,00
522.7775.29C	NA	CONSIGNE ETRIER		NET	20,00
522.7775.73	7,510	ETRIER GAUCHE RT	BREMBO PF 2.44	VI	228,00
522.7775.73C	NA	CONSIGNE ETRIER		NET	20,00
522.7775.83	7,510	ETRIER DROIT RT	BREMBO PF 2.44	VI	228,00
522.7775.83C	NA	CONSIGNE ETRIER		NET	20,00
522.8142.32	NA	ETRIER GAUCHE CITROEN FIAT PEUGEOT	BREMBO PF 2.44/48		262,00
522.8142.32C	NA	CONSIGNE ETRIER		NET	20,00
522.8142.42	5,400	ETRIER GAUCHE CITROEN FIAT PEUGEOT	BREMBO PF 2.44/48	VI	262,00
522.8142.42C	NA	CONSIGNE ETRIER		NET	20,00
522.8142.45	5,400	ETRIER GAUCHE CITROEN FIAT PEUGEOT	BREMBO PF 2.44/48	VI	262,00
522.8142.45C	NA	CONSIGNE ETRIER		NET	20,00
522.8142.46	5,380	ETRIER GAUCHE CITROEN FIAT PEUGEOT	BREMBO PF 2.44/48	VI	262,00
522.8142.46C	NA	CONSIGNE ETRIER		NET	20,00
522.8142.55	6,000	ETRIER GAUCHE CITROEN FIAT PEUGEOT	BREMBO PF 2.44/48	VI	262,00
522.8142.55C	NA	CONSIGNE ETRIER		NET	20,00
522.8142.56	5,320	ETRIER GAUCHE CITROEN FIAT PEUGEOT	BREMBO PF 2.44/48	VI	262,00
522.8142.56C	NA	CONSIGNE ETRIER		NET	20,00
522.8148.45	5,800	ETRIER GAUCHE CITROEN FIAT PEUGEOT	BREMBO PF 2.46/52	VI	262,00
522.8148.45C	NA	CONSIGNE ETRIER		NET	20,00
522.8148.46	5,780	ETRIER GAUCHE CITROEN FIAT PEUGEOT	BREMBO PF 2.46/52	VI	262,00
522.8148.46C	NA	CONSIGNE ETRIER		NET	20,00
522.8148.55	5,760	ETRIER GAUCHE CITROEN FIAT PEUGEOT	BREMBO PF 2.46/52	VI	262,00
522.8148.55C	NA	CONSIGNE ETRIER		NET	20,00
522.8148.56	5,620	ETRIER GAUCHE CITROEN FIAT PEUGEOT	BREMBO PF 2.46/52	VI	262,00
522.8148.56C	NA	CONSIGNE ETRIER		NET	20,00
522.8153.12	4,700	ETRIER GAUCHE CITROEN FIAT PEUGEOT	BREMBO PF 1.46	VI	262,00
522.8153.12C	NA	CONSIGNE ETRIER		NET	20,00
522.8153.22	3,380	ETRIER GAUCHE CITROEN FIAT PEUGEOT	BREMBO PF 1.46	VI	262,00
522.8153.22C	NA	CONSIGNE ETRIER		NET	20,00
522.9272.01	7,160	ETRIER GAUCHE IVECO	BREMBO PF 2.44	VI	308,00
522.9272.01C	NA	CONSIGNE ETRIER		NET	20,00
522.9272.02	7,200	ETRIER DROIT IVECO	BREMBO PF 2.44	VI	308,00
522.9272.02C	NA	CONSIGNE ETRIER		NET	20,00
522.9700.10	7,440	ETRIER GAUCHE IVECO	BREMBO PF 2.48	VI	276,00
522.9700.10C	NA	CONSIGNE ETRIER		NET	20,00
522.9700.20	7,500	ETRIER DROIT IVECO	BREMBO PF 2.48	VI	276,00
522.9700.20C	NA	CONSIGNE ETRIER		NET	20,00
522.9700.76	7,620	ETRIER GAUCHE RT NISSAN	BREMBO PF 2.48	VI	284,00
522.9700.76C	NA	CONSIGNE ETRIER		NET	20,00



ETRIERS, PLAQUETTES, TEMOINS D'USURE
ET FLASQUES PARKING
Applicable au 1 Avril 2019



BREMBO	Poids	DESIGNATION	OBS	REM	PRIX HT
522.9700.86	7,620	ETRIER DROIT RT NISSAN	BREMBO PF 2.48	VI	284,00
522.9700.86C		NA CONSIGNE ETRIER		NET	20,00
522.9715.75	8,670	ETRIER GAUCHE RT NISSAN	BREMBO PFC 1.46	VI	330,00
522.9715.75C		NA CONSIGNE ETRIER		NET	30,00
522.9715.85	8,670	ETRIER DROIT RT NISSAN	BREMBO PFC 1.46	VI	330,00
522.9715.85C		NA CONSIGNE ETRIER		NET	30,00
522.9721.00	8,000	ETRIER GAUCHE IVECO	BREMBO PFC 1.60	VI	388,00
522.9721.00C		NA CONSIGNE ETRIER		NET	30,00
522.9721.01	8,000	ETRIER DROIT IVECO	BREMBO PFC 1.60	VI	388,00
522.9721.01C		NA CONSIGNE ETRIER		NET	30,00
522.9782.10	8,600	ETRIER GAUCHE IVECO	BREMBO PF 2.48	VI	414,00
522.9782.10C		NA CONSIGNE ETRIER		NET	20,00
522.9782.20	8,600	ETRIER DROIT IVECO	BREMBO PF 2.48	VI	414,00
522.9782.20C		NA CONSIGNE ETRIER		NET	20,00
522.9788.10	14,600	ETRIER GAUCHE IVECO	BREMBO PF 2.60	VI	582,00
522.9788.10C		NA CONSIGNE ETRIER		NET	20,00
522.9788.20	14,600	ETRIER DROIT IVECO	BREMBO PF 2.60	VI	582,00
522.9788.20C		NA CONSIGNE ETRIER		NET	20,00
522.9800.08	17,580	ETRIER GAUCHE IVECO	BREMBO PF 2.60	VI	466,00
522.9800.08C		NA CONSIGNE ETRIER		NET	20,00
522.9800.09	17,580	ETRIER DROIT IVECO	BREMBO PF 2.60	VI	466,00
522.9800.09C		NA CONSIGNE ETRIER		NET	20,00
522.9801.08	21,060	ETRIER GAUCHE IVECO	BREMBO PFC 2.60	VI	630,00
522.9801.08C		NA CONSIGNE ETRIER		NET	20,00
522.9801.09	21,060	ETRIER DROIT IVECO	BREMBO PFC 2.60	VI	630,00
522.9801.09C		NA CONSIGNE ETRIER		NET	20,00
522.9802.08	18,840	ETRIER GAUCHE IVECO	BREMBO PF 2.68	VI	466,00
522.9802.08C		NA CONSIGNE ETRIER		NET	20,00
522.9802.09	18,840	ETRIER DROIT IVECO	BREMBO PF 2.68	VI	466,00
522.9802.09C		NA CONSIGNE ETRIER		NET	20,00
522.9803.08	22,400	ETRIER GAUCHE IVECO	BREMBO PFC 2.68	VI	750,00
522.9803.08C		NA CONSIGNE ETRIER		NET	20,00
522.9803.09	22,000	ETRIER DROIT IVECO	BREMBO PFC 2.68	VI	750,00
522.9803.09C		NA CONSIGNE ETRIER		NET	20,00
527.5960.77	4,700	FLASQ. PK GAUCHE IVE	D.I.H. Ø 172	VI	178,00
527.5960.87	4,700	FLASQ. PK DROITE IVE	D.I.H. Ø 172	VI	178,00
527.5972.50	0,080	REGLEUR		VI	35,00
527.7704.12	7,000	FLASQ. PK GAUCHE IVE	D.I.H. Ø 190	VI	244,00
527.7704.19	7,000	FLASQ. PK GAUCHE IVE	D.I.H. Ø 190	VI	244,00
527.7704.22	7,000	FLASQ. PK DROITE IVE	D.I.H. Ø 190	VI	244,00
527.7704.29	7,000	FLASQ. PK DROITE IVE	D.I.H. Ø 190	VI	244,00

REF	Poids	DESIGNATION	MARQUE	REM	PRIX HT
FVR829	1,793	PLAQUETTES FREIN DAF 400 LDV CONVOY	FERODO	FE001	75,25
FVR839	NA	PLAQUETTES FREIN IVECO DAILY TU+	FERODO	FE001	NA
FVR239	2,490	PLAQUETTES FREIN MERCEDES T1	FERODO	FE001	72,32
FVR836	1,979	PLAQUETTES FREIN DAF 400 LDV CONVOY	FERODO	FE001	67,55
FVR511	1,905	PLAQUETTES FREIN IVECO DAILY TU+	FERODO	FE001	104,05
FVR941	NA	PLAQUETTES FREIN MERCEDES MB100 D	FERODO	FE001	NA
FVR4840	2,316	PLAQUETTES FREIN OPEL RENAULT	FERODO	FE001	83,99
FVR1515	2,034	PLAQUETTES FREIN NISSAN OPEL RENAULT TRAFIC	FERODO	FE001	75,00
FVR1292	1,829	PLAQUETTES FREIN OPEL MOVANO, RENAULT MASTER	FERODO	FE001	75,38
FVR1616	2,439	PLAQUETTES FREIN NISSAN CABSTAR	FERODO	FE001	94,85
FVR1452	2,154	PLAQUETTES FREIN NISSAN OPEL RENAULT MASTER	FERODO	FE001	75,27
FVR1453	1,238	PLAQUETTES FREIN NISSAN OPEL RENAULT MASTER	FERODO	FE001	75,27
FVR1876	1,586	PLAQUETTES FREIN MERCEDES VOLKSWAGEN	FERODO	FE001	74,28
FVR1478	2,306	PLAQUETTES FREIN CITROËN FIAT PEUGEOT	FERODO	FE001	142,90
FVR1479	2,677	PLAQUETTES FREIN CITROËN FIAT PEUGEOT	FERODO	FE001	140,55
FVR1480	1,443	PLAQUETTES FREIN CITROËN FIAT PEUGEOT	FERODO	FE001	115,14
FVR4054	1,509	PLAQUETTES FREIN NISSAN CABSTAR RT MAXITY	FERODO	FE001	100,16
FVR1516	1,254	PLAQUETTES FREIN NISSAN OPEL RENAULT TRAFIC	FERODO	FE001	75,27
FVR1038	1,917	PLAQUETTES FREIN MERCEDES, VOLKSWAGEN TU+	FERODO	FE001	84,58
FVR1039	1,165	PLAQUETTES FREIN MERCEDES, VOLKSWAGEN TU-	FERODO	FE001	72,01
FVR4348	1,625	PLAQUETTES FREIN NISSAN OPEL RENAULT MASTER	FERODO	FE001	75,27
FVR4347	2,426	PLAQUETTES FREIN NISSAN OPEL RENAULT MASTER	FERODO	FE001	76,32
FVR4349	2,220	PLAQUETTES FREIN NISSAN OPEL RENAULT MASTER	FERODO	FE001	77,89
FCV5000B	NA	PLAQUETTES FREIN ISUZU NPR 3,5T FER3196	FERODO	FE001	NA
FCV668	4,124	PLAQUETTES FREIN RENAULT TRUCKS MIDLINER 3538F	FERODO	FE011	101,30
FCV503	4,662	PLAQUETTES FREIN DAF 45 3422F	FERODO	FE011	104,75
FVR713	1,853	PLAQUETTES FREIN IVECO DAILY TU+	FERODO	FE001	107,24
FCV702	4,422	PLAQUETTES FREIN VOLVO FL 3422F	FERODO	FE011	79,01
FVR655	1,883	PLAQUETTES FREIN IVECO DAILY TU+	FERODO	FE001	121,08
FCV1940	6,221	PLAQUETTES FREIN IRISBUS FR1 4550F	FERODO	FE011	148,07
FCV879	4,302	PLAQUETTES FREIN RENAULT TRUCKS MIDLINER 3475F	FERODO	FE011	96,13
FCV733	4,385	PLAQUETTES FREIN IVECO RT MIDLINER 3475F	FERODO	FE011	90,50
FVR627	2,660	PLAQUETTES FREIN RENAULT TRUCKS B SERIE	FERODO	FE001	111,00
FCV1046	4,163	PLAQUETTES FREIN RENAULT TRUCKS MIDLINER 3538F	FERODO	FE011	110,00
FVR1350	NA	PLAQUETTES FREIN IVECO DAILY 59	FERODO	FE011	NA
FVR1102	2,417	PLAQUETTES FREIN IVECO DAILY TH. 20,3	FERODO	FE001	89,99
FVR1315	2,225	PLAQUETTES FREIN IVECO DAILY RT TH.17	FERODO	FE001	102,12
FVR4156	2,519	PLAQUETTES FREIN NISSAN CABSTAR RT MAXITY	FERODO	FE001	105,26
FCV1126	4,387	PLAQUETTES FREIN IVECO EUROCARGO 3475F	FERODO	FE011	82,00
FVR1405	1,857	PLAQUETTES FREIN IVECO DAILY	FERODO	FE001	99,98
FVR4140	1,815	PLAQUETTES FREIN IVECO DAILY	FERODO	FE001	155,45
FVR1351	2,467	PLAQUETTES FREIN IVECO DAILY	FERODO	FE001	154,96
FVR1353	2,054	PLAQUETTES FREIN IVECO DAILY	FERODO	FE001	108,22
FVR1879	2,318	PLAQUETTES FREIN MERCEDES SPRINTER VW LT	FERODO	FE001	90,90
FVR1390	2,945	PLAQUETTES FREIN IVECO DAILY RT MASCOTT	FERODO	FE001	147,56
FVR1780	1,702	PLAQUETTES FREIN MERCEDES SPRINTER VW TU+	FERODO	FE001	82,00
FVR1778	2,680	PLAQUETTES FREIN MERCEDES SPRINTER VW TU-	FERODO	FE001	92,90
FVR4470	3,040	PLAQUETTES FREIN MERCEDES SPRINTER VW TU-	FERODO	FE001	115,00
FVR1761	1,723	PLAQUETTES FREIN MULTICAR M26	FERODO	FE001	303,96
FVR1779	2,462	PLAQUETTES FREIN MERCEDES SPRINTER VW TU-	FERODO	FE001	82,00
FVR4429	2,625	PLAQUETTES FREIN MERCEDES SPRINTER VW TU+	FERODO	FE001	80,80
FVR4036	2,891	PLAQUETTES FREIN IVECO DAILY	FERODO	FE001	197,99
FVR4053	2,894	PLAQUETTES FREIN NISSAN CABSTAR RT MAXITY	FERODO	FE001	129,15
FVR4039	2,723	PLAQUETTES FREIN IVECO DAILY	FERODO	FE001	283,33
FVR4037	2,531	PLAQUETTES FREIN IVECO DAILY	FERODO	FE001	196,97

REF	Poids	DESIGNATION	MARQUE	REM	PRIX HT
FVR1791	2,829	PLAQUETTES FREIN MERCEDES SPRINTER	FERODO	FE001	90,90
FVR4253	3,114	PLAQUETTES FREIN MITSUBISHI CANTER	FERODO	FE001	132,51
FVR1906	3,739	PLAQUETTES FREIN MITSUBISHI CANTER	FERODO	FE001	113,63
FVR4314	NA	PLAQUETTES FREIN MITSUBISHI CANTER	FERODO	FE001	NA
FCV4254	5,126	PLAQUETTES FREIN IVECO EUROCARGO 3422	FERODO	FE011	103,68
FCV1853	NA	PLAQUETTES FREIN ISUZU NPR NQR 7,5T FER3196	FERODO	FE011	NA
FVR4248	2,960	PLAQUETTES FREIN NISSAN CABSTAR RT MAXITY	FERODO	FE001	138,90
FDB143	1,298	PLAQUETTES FREIN MERCEDES MB TRAC, UNIMOG	FERODO	FE001	53,58
FCV958	7,007	PLAQUETTES FREIN MERCEDES UNIMOG 3475F	FERODO	FE011	285,79
FCV959	4,005	PLAQUETTES FREIN MERCEDES UNIMOG 3475F	FERODO	FE011	180,37
FVR1522	4,164	PLAQUETTES FREIN MERCEDES VARIO	FERODO	FE001	121,50
FVR792	2,728	PLAQUETTES FREIN NISSAN CABSTAR	FERODO	FE001	124,23
DDF089-1	11,100	DISQUE FREIN IVECO DAILY	FERODO	FE003	139,50
DDF1067C	14,521	DISQUE FREIN RENAULT MASTER II	FERODO	FE003	269,30
DDF1144	15,197	DISQUE FREIN CITROËN FIAT PEUGEOT	FERODO	FE003	236,90
DDF1145	15,145	DISQUE FREIN CITROËN FIAT PEUGEOT	FERODO	FE003	241,26
DDF1170	14,494	DISQUE FREIN CITROËN FIAT PEUGEOT	FERODO	FE003	264,42
DDF1204C-1	9,850	DISQUE FREIN RENAULT TRAFIC II	FERODO	FE003	134,65
DDF1217C-1	10,300	DISQUE FREIN RENAULT MASTER II	FERODO	FE003	135,20
DDF1272	13,601	DISQUE FREIN RENAULT MASTER II	FERODO	FE003	125,30
DDF1623-1	9,400	DISQUE FREIN NISSAN OPEL RENAULT (Bearing+)	FERODO	FE002	126,99
DDF1974C-1	10,150	DISQUE FREIN MASTER IV AV	FERODO	FE003	134,65
DDF1975C	12,800	DISQUE FREIN MASTER III AR TRACTION	FERODO	FE003	253,00
DDF1976C	14,600	DISQUE FREIN MASTER III AR R.SIMPLE PROPULSION	FERODO	FE003	265,83
DDF1977	NA	DISQUE FREIN MASTER III AR R.JUMEELEE PROPULSION	FERODO	FE003	NA
DDF2507C	18,270	DISQUE FREIN RENAULT TRAFIC	FERODO	FE003	267,17
DDF254-1	NA	DISQUE FREIN IVECO DAILY	FERODO	FE003	NA
DDF768	16,591	DISQUE FREIN CITROËN FIAT PEUGEOT	FERODO	FE003	263,90
FCR101A	13,000	DISQUE FREIN DAF	FERODO	FE011	104,62
FCR102A	14,000	DISQUE FREIN DAF	FERODO	FE011	119,63
FCR104A	13,690	DISQUE FREIN IVECO DAILY (GOUJONS +)	FERODO	FE011	75,98
FCR105A	15,000	DISQUE FREIN IVECO EUROCARGO (ABS-)	FERODO	FE011	99,56
FCR106A	18,000	DISQUE FREIN IVECO EUROCARGO (ABS-)	FERODO	FE011	118,53
FCR116A	7,000	DISQUE FREIN MERCEDES 207D	FERODO	FE011	22,99
FCR117A	9,000	DISQUE FREIN MERCEDES 407D	FERODO	FE011	60,34
FCR118A	10,470	DISQUE FREIN MERCEDES VARIO	FERODO	FE011	42,25
FCR126A	14,000	DISQUE FREIN RENAULT TRUCKS MIDLINER	FERODO	FE011	84,16
FCR128A	30,000	DISQUE FREIN IRISBUS FR1	FERODO	FE011	152,90
FCR130A	13,500	DISQUE FREIN VOLVO FL	FERODO	FE011	109,99
FCR131A	14,000	DISQUE FREIN VOLVO FL	FERODO	FE011	106,67
FCR133A	21,000	DISQUE FREIN IVECO DAILY 59-12 (GOUJONS +)	FERODO	FE011	151,71
FCR139A	15,208	DISQUE FREIN IVECO DAILY (GOUJONS +)	FERODO	FE011	63,11
FCR140A	9,457	DISQUE FREIN IVECO DAILY (DIH)	FERODO	FE011	42,49
FCR142A	16,000	DISQUE FREIN VOLVO FL	FERODO	FE011	124,45
FCR156A	15,600	DISQUE FREIN MERCEDES MB TRAC - UNIMOG	FERODO	FE011	104,16
FCR163A	NA	DISQUE FREIN MERCEDES VARIO	FERODO	FE011	NA
FCR164A	11,000	DISQUE FREIN MERCEDES VARIO	FERODO	FE011	61,89
FCR165A	12,400	DISQUE FREIN MERCEDES VARIO	FERODO	FE011	59,32
FCR169A	7,000	DISQUE FREIN RENAULT GAMME B	FERODO	FE011	59,81
FCR182A	8,000	DISQUE FREIN RENAULT TRUCKS MASCOTT	FERODO	FE011	56,21
FCR183A	6,400	DISQUE FREIN RENAULT TRUCKS MASCOTT	FERODO	FE011	53,86
FCR184A	7,800	DISQUE FREIN RENAULT MASCOTT AR (DIH)	FERODO	FE011	58,00
FCR191A	7,350	DISQUE FREIN MERCEDES SPRINTER (DIH)	FERODO	FE011	29,91
FCR194A	8,500	DISQUE FREIN IVECO DAILY	FERODO	FE011	54,74
FCR195A	6,500	DISQUE FREIN IVECO DAILY (ABS-)	FERODO	FE011	63,35

REF	Poids	DESIGNATION	MARQUE	REM	PRIX HT
FCR196A	13,000	DISQUE FREIN IVECO DAILY (ABS+)	FERODO	FE011	73,53
FCR229A	7,120	DISQUE FREIN MERCEDES -VW (DIH)	FERODO	FE011	28,01
FCR230A	6,600	DISQUE FREIN MERCEDES -VW (DIH)	FERODO	FE011	29,91
FCR235A	7,632	DISQUE FREIN IVECO DAILY	FERODO	FE011	77,09
FCR236A	13,850	DISQUE FREIN IVECO DAILY (DIH)	FERODO	FE011	102,90
FCR261A	6,800	DISQUE FREIN NISSAN CABSTAR 276 MM 5 TROUS	FERODO	FE011	80,59
FCR306A	14,200	DISQUE FREIN VOLVO FL	FERODO	FE011	70,78
FCR310A	9,350	DISQUE FREIN MERCEDES -VW	FERODO	FE011	42,02
FCR311A	7,600	DISQUE FREIN MERCEDES -VW (DIH - Screw+)	FERODO	FE011	32,71
FCR312A	9,300	DISQUE FREIN MERCEDES -VW (DIH)	FERODO	FE011	52,90
FCR313A	15,427	DISQUE FREIN IVECO DAILY (GOUJONS +)	FERODO	FE011	78,23
FCR314A	8,480	DISQUE FREIN IVECO DAILY	FERODO	FE011	42,49
FCR315A	7,800	DISQUE FREIN IVECO DAILY (ABS-)	FERODO	FE011	83,93
FCR316A	7,432	DISQUE FREIN IVECO DAILY (ABS+)	FERODO	FE011	77,64
FCR317A	8,432	DISQUE FREIN IVECO DAILY	FERODO	FE011	44,59
FCR320A	8,232	DISQUE FREIN IVECO DAILY (ABS-)	FERODO	FE011	119,89
FCR321A	8,432	DISQUE FREIN IVECO DAILY (ABS+)	FERODO	FE011	79,15
FCR322A	NA	DISQUE FREIN IVECO EUROCARGO (ABS+)	FERODO	FE011	NA
FCR326A	NA	DISQUE FREIN RT MAXITY NISSAN CABSTAR	FERODO	FE011	NA
FCR327A	NA	DISQUE FREIN RT MAXITY NISSAN CABSTAR (ABS-)	FERODO	FE011	NA
FCR329A	9,750	DISQUE FREIN IVECO DAILY	FERODO	FE011	93,86
FCR332A	13,800	DISQUE FREIN IVECO DAILY (DIH)	FERODO	FE011	132,75
FCR338A	19,600	DISQUE FREIN IVECO EUROCARGO (ABS-)	FERODO	FE011	181,89
FCR339A	9,000	DISQUE FREIN RT MAXITY NISSAN CABSTAR	FERODO	FE011	72,62
FCR340A	8,000	DISQUE FREIN NISSAN CABSTAR RT MAXITY (DIH)	FERODO	FE011	47,96
FCR341A	18,400	DISQUE FREIN IVECO EUROCARGO (ABS+)	FERODO	FE011	171,87
FCR342A	19,000	DISQUE FREIN IVECO EUROCARGO (ABS+)	FERODO	FE011	203,88
FCR343A	9,800	DISQUE FREIN IVECO DAILY 4X4	FERODO	FE011	73,24
FCR364A	NA	DISQUE FREIN MERCEDES MB TRAC - UNIMOG	FERODO	FE011	NA
FCR369A	NA	DISQUE FREIN RT MAXITY NISSAN CABSTAR (ABS+)	FERODO	FE011	NA
17016301561	NA	JEU GARNITURES COLAERT 406X120 EP.11 Q. 1561	BERAL	VI	240,00
17582003548	2,588	GARNITURES FREIN RT 356X100 FERODO 3548 CO	FERODO	VI	160,00
17804003657	4,072	JEU GARNITURES RT 394X127 FERODO 3657 CO	FERODO	VI	165,00
17829003529	1,679	JEU GARNITURES RT 310X100 FERODO 3529 CO	FERODO	VI	138,00
FCV1389	8,210	PLAQUETTES FREIN RT WABCO PAN 19-2 FERODO 4572	FERODO	VI	170,00
FCV4420B	9,000	PLAQUETTES FREIN SAF GIGANT HALDEX DBT22LT J442	FERODO	VI	159,56
FCV4418PTS	10,200	PLAQUETTES FREIN ACTROS MP4 KNORR SL7 MB7211-0	FERODO	VI	171,68
FCV4417PTS	8,600	PLAQUETTES FREIN ACTROS MP4 KNORR SM7 MB7111-0	FERODO	VI	187,01
2925305390	10,000	PLAQUETTES FREIN KNORR PROTEC S JURID 539	JURID	VI	135,73
FCV4344PTS	10,000	PLAQUETTES FREIN KNORR PROTEC S FERODO 4569F	FERODO	VI	135,73
2925705390	9,373	PLAQUETTES FREIN MERCEDES SAF KNORR PTEC S J539	JURID	VI	145,18
FCV4461PTS	9,373	PLAQUETTES FREIN MERCEDES SAF KNORR PTEC S F5200	FERODO	VI	145,18
2932805390	8,600	PLAQUETTES FREIN KNORR ST7 JURID J539	JURID	VI	190,00
FCV4736PTS	8,600	PLAQUETTES FREIN KNORR ST7 FERODO J539	FERODO	VI	190,00
55173001517	NA	JEU GARNITURES BPW 310X80 BERAL 1561 CO	BERAL	VI	180,00
57248001561	NA	JEU GARNITURES COLAERT ADR 300X135 BERAL 1561 CO	BERAL	VI	150,00
57250001561	NA	JEU GARNITURES COLAERT ADR 300X135 BERAL 1561 CO	BERAL	VI	150,00
57251001561	NA	JEU GARNITURES COLAERT ADR 300X100 BERAL 1561 CO	BERAL	VI	150,00
59335001561	NA	JEU GARNITURES COLAERT ADR 300X160 BERAL 1561 CO	BERAL	VI	160,00
59338001561	NA	JEU GARNITURES COLAERT ADR 300X150 BERAL 1561 CO	BERAL	VI	160,00
FCR145A	33,500	DISQUE FREIN MERCEDES ACTROS FERODO	FERODO	VI	150,00
FCR323A	34,850	DISQUE FREIN MERCEDES ACTROS FERODO	FERODO	VI	216,00

REF GIL	Poids	DESIGNATION	OBS	REM	PRIX HT
1346400412	NA	GARNITURES FREIN FREIN RT SG 305X45	13464	VI	200,00
1505700928	NA	JEU GARNITURES MERCEDES 300X90 CO Q928	15057	VI	240,00
1524700929	NA	JEU GARNITURES BPW 400X80 Q 929 CO	15247	VI	260,00
15789007000	NA	GARNITURES FREIN FORD 330X76,2 CO +RIVETS	15789	VI	178,00
15831/1583200412	NA	GARNITURES FREIN 305X70 CO	15831	VI	238,00
1705015412	NA	GARNITURES FREIN IVECO 400X100 +1.5MM	17050	VI	275,00
17115001517	NA	GARNITURES FREIN COLAERT 406X120 EP.10	17115	VI	218,00
17237001549	NA	JEU GARNITURES GRUE 500X120 8 T. CO BERAL 1549	17237	VI	400,00
17237002200	NA	GARNITURES FREIN GRUE 500X120 8 T. CO + RIVETS	17237	VI	400,00
1723800AF/710	5,100	GARNITURES FREIN MERCEDES 410X143	17238	VI	164,00
1725910412	NA	JEU GARNITURES MERCEDES 408X120 EP 10.3	17259	VI	250,00
17280/92820AF/710	2,490	GARNITURES FREIN MERCEDES 308x120	17280;1792820	VI	143,00
1730700928	NA	JEU GARNITURES RT 406X125 EP.10 CO	17307	VI	250,00
1730710928	NA	JEU GARNITURES RT 406X125 EP.11 +1MM	17307	VI	250,00
17309007000	NA	GARNITURES FREIN RT 414X125 HM7000 + RIVETS	17309	VI	188,00
1735010	NA	JEU GARNITURES MERCEDES 300X102,5 +1MM + RIVETS	17350	VI	390,00
17351/97500AF/710	NA	GARNITURES FREIN MERCEDES 300x122,5	17351;17975	VI	117,00
1735200929	NA	JEU GARNITURES RT 310X125 CO QUAL 929	17352	VI	240,00
1735210929	NA	JEU GARNITURES RT 310X125 +1MM QUAL 929	17352	VI	264,00
1735700929	NA	JEU GARNITURES VOLVO 360X140 CO QUAL929	17357	VI	300,00
17374001549	NA	JEU GARNITURES GRUE 500X120 10 T. CO BERAL 1549	17374	VI	480,00
17374002200	NA	GARNITURES FREIN GRUE 500X120 10 T. CO + RIVETS	17374	VI	400,00
17374201549	NA	JEU GARNITURES GRUE 500X120 10 TROUS + 2MM	17374	VI	444,00
1740920AF/710	NA	GARNITURES FREIN MERCEDES 304x135	1740920	VI	107,00
17556007000	NA	JEU GARNITURES FORD 307,9X101.6 CO + RIVETS	17556	VI	286,00
17582101549	NA	JEU GARNITURES RT 356X100 Q 1549 +1MM	17582	VI	230,00
17592001541	NA	GARNITURES FREIN SAE 305X125 CO QUAL 1541	17592	VI	298,00
1763500929	NA	JEU GARNITURES OM 325X120 QUAL 929 CO	17635	VI	270,00
1768200AF/700	NA	GARNITURES FREIN MERCEDES 410X120	17682	VI	90,00
1776010929	NA	JEU GARNITURES SAE 406X100 +1MM	17760	VI	276,00
17795/79600AF/700	6,114	GARNITURES FREIN MERCEDES 410X143	17795;17796	VI	111,00
1780400412	4,072	GARNITURES FREIN RT 394X127	17804	VI	178,00
1780410412	NA	GARNITURES FREIN RT 394X127 +1MM	17804	VI	194,00
1780420412	NA	JEU GARNITURES RT 394X127 +1MM	17804	VI	224,00
17805001549	NA	JEU GARNITURES RT 356X100 CO QUAL 1549	17805	VI	276,00
1782700929	NA	JEU GARNITURES RT 325X120 QUAL 929 CO	17827	VI	224,00
1782710929	NA	JEU GARNITURES RENAULT TRUCKS 325X120 Q929 +1MM	17827	VI	248,00
1782910929	NA	JEU GARNITURES RT 310X100 Q929 +1mm	17829	VI	310,00
1783100928	NA	JEU GARNITURES RT 310X125 CO Q 928	17831	VI	330,00
1783110928	NA	JEU GARNITURES RT 310X125 +1MM Q 928	17831	VI	367,00
17897001541	NA	JEU GARNITURES SAE 305X125 Q 1541 CO	17897	VI	312,00
17900/90100412	NA	GARNITURES FREIN	17900	VI	208,00
1792920AF/700	3,220	GARNITURES FREIN MERCEDES 308X135	1792920;17287	VI	137,00
17932007000	NA	JEU GARNITURES FORD 330.2X127 CO +RIVETS	17932	VI	218,00
1799100AF/710	3,930	GARNITURES FREIN SCANIA 127 (412,8)	17991	VI	102,00
1799200AF/710	5,195	GARNITURES FREIN VOLVO 125 Z (410)	17992	VI	102,00
1799280	NA	KIT MACHOIRES GARNIES VOLVO 410X125 T088 CO	17992	VI	450,00
19010/1100AF/710	7,370	GARNITURES FREIN DAF 150 (420) AM	19010;19011	VI	123,00
19030/03300AF/700	10,040	GARNITURES FREIN ROR 419X178 Q+	19030;19033	VI	109,00
1903200AF/700	8,360	GARNITURES FREIN BPW 410X180	19032	VI	86,00
19036/03700AF/720	7,515	GARNITURES FREIN ROR 419X178	19036;19037	VI	88,00
19041001549	NA	JEU GARNITURES GRUE 500X180 14 T. CO BERAL 1549	19041	VI	440,00
19041002200	NA	JEU GARNITURES GRUE 500X180 14 T. CO + RIVETS	19041	VI	440,00
19042001549	NA	JEU GARNITURES GRUE 500X160 10 T. CO BERAL 1549	19042	VI	480,00
19042002200	NA	JEU GARNITURES GRUE 500X160 10 T. CO + RIVETS	19042	VI	440,00
1904900929	NA	JEU GARNITURES RT 414X150 CO 929	19049	VI	298,00
19052/05500AF/710	8,177	GARNITURES FREIN DAF 420X175	19052;19055	VI	160,00
19063/6400AF/710	9,890	GARNITURES FREIN DAF 200 (420) NM	19063;19064	VI	149,00

REF GIL	Poids	DESIGNATION	OBS	REM	PRIX HT
1906380	NA	KIT MACHOIRES GARNIES 420X200 T088 CO + ACC	19063;19064	VI	700,00
1906800AF/710	9,985	GARNITURES FREIN VOLVO 410X225 Z	19068	VI	129,00
1906810AF/700	10,680	GARNITURES FREIN VOLVO 410X225 Z +1MM	19068	VI	129,00
1906810AF/710	10,680	GARNITURES FREIN VOLVO 410X225 Z +1MM	19068	VI	143,00
1906880	32,000	KIT MACHOIRES GARNIES RT VOLVO 410X225 T088 CO	19068	VI	396,00
19069/7700AF/710	11,185	GARNITURES FREIN DAF 420X240	19069;19077	VI	264,00
1907100AF/700	8,300	GARNITURES FREIN VOLVO 410X200 Z CO	19071	VI	107,00
1907100AF/710	8,300	GARNITURES FREIN VOLVO 410X200 Z CO	19071	VI	119,00
1907110AF/700	9,300	GARNITURES FREIN VOLVO 410X200 Z +1MM	19071	VI	119,00
1907110AF/710	9,300	GARNITURES FREIN VOLVO 410X200 Z +1MM	19071	VI	129,00
1907180	32,000	KIT MACHOIRES GARNIES RT VOLVO 410X200 T088 CO	19071	VI	396,00
1907500AF/710	8,860	GARNITURES FREIN SCANIA 413x178	19075	VI	137,00
19078/11220AF/700	6,455	GARNITURES FREIN MERCEDES	19078;19112 20	VI	102,00
1909000AF/700	7,230	GARNITURES FREIN RT VOLVO 410X175 Z CO	19090	VI	92,00
1909000AF/710	7,230	GARNITURES FREIN RT VOLVO 410X175 Z CO	19090	VI	102,00
1909010AF/700	8,230	GARNITURES FREIN RT VOLVO 410X175 Z +1MM	19090	VI	100,00
1909010AF/710	8,230	GARNITURES FREIN RT VOLVO 410X175 Z +1MM	19090	VI	115,00
1909080	32,000	KIT MACHOIRES GARNIES RT VOLVO 410X175 T088 CO	19090	VI	396,00
1909178	34,000	KIT MACHOIRES GARNIES IVECO PERROT 410X202 CO	19091;19098	VI	780,00
1909180	35,500	KIT MACH. GARN. IVECO PERROT 410X202 CO +ACC	19091;19098	VI	880,00
1909400AF/700	9,400	GARNITURES FREIN BPW 410X200	19094	VI	88,00
1909400AF/720	NA	GARNITURES FREIN BPW 420X200	19094	VI	88,00
1909410AF/700	10,058	GARNITURES FREIN BPW 410X200 +1 MM	19094	VI	94,00
1909978	29,800	KIT MACH. GARN. IVECO PERROT 410X182 D7141 CO	19099;19100	VI	780,00
1909980	31,500	KIT MACHOIRES GARN. IVECO PERROT 410X182 CO+ACC	19099;19100	VI	880,00
1910978	NA	KIT MACH. GARN. IVECO 410X180 ROC. DUPLEX CO	19109;19110	VI	780,00
1910978NV	NA	KIT MACH. GARN. IVECO 410X180 ROC. DUPLEX CO NV	19109;19110	VI	780,00
1910980	NA	KIT MACH. GARN. IVECO 410X180 ROC. DUP. CO+ACC	19109;19110	VI	880,00
1910980NV	NA	KIT MACH. GARN. IVECO 410X180 ROC. DUP. CO+ACC	19109;19110	VI	880,00
19113001549	NA	JEU GARNITURES GRUE 410X180 10 T. CO BERAL 1549	19113	VI	460,00
19113002200	NA	JEU GARNITURES GRUE 410X180 10 T. CO + RIVETS	19113	VI	380,00
19116/11900AF/700	10,730	GARNITURES FREIN IVECO 410X200 ROCKWELL 2	19116;19119	VI	173,00
19116/11900AF/710	10,730	GARNITURES FREIN IVECO 410X200 ROCKWELL 2	19116;19119	VI	198,00
19116/11910AF/700	11,730	GARNITURES FREIN IVECO 410X200 ROCKWELL 2 +1 MM	19116;19119	VI	198,00
1911678	NA	KIT MACH. GARN. IVECO 410X200 ROC. DUPLEX CO	19116;19119	VI	780,00
1911678NV	NA	KIT MACH. GARN. IVECO 410X200 ROC. DUPLEX CO NV	19116;19119	VI	780,00
1911680	NA	KIT MACH. GARN. IVECO 410X200 ROC. DUP. CO+ACC	19116;19119	VI	880,00
1911680NV	NA	KIT MACH. GARN. IVECO 410X200 ROC. DUP. CO+ACC	19116;19119	VI	880,00
19166/16700AF/665	11,120	GARNITURES FREIN KASSBOHRER 400X200	19166;19167	VI	151,00
19168/16900AF/710	NA	GARNITURES FREIN KASSBOHRER 400X150	19168;19169	VI	151,00
1917700AF/710	NA	GARNITURES FREIN MAN 360X163	19177	VI	164,00
1918700AF/700	11,297	GARNITURES FREIN RVI 220 (414)	19187	VI	129,00
1918700AF/710	11,297	GARNITURES FREIN RVI 220 (414)	19187	VI	143,00
1918710AF/700	12,290	GARNITURES FREIN RVI 220 (414) +1MM	19187	VI	143,00
1918710AF/710	12,290	GARNITURES FREIN RVI 220 (414) +1MM	19187	VI	156,00
1918720AF/700	12,760	GARNITURES FREIN RVI 220 (414) +2MM	19187	VI	156,00
1918720AF/710	12,760	GARNITURES FREIN RVI 220 (414) +2MM	19187	VI	172,00
1918778	NA	KIT MACHOIRES GARNIES RVI 414X220 T088 CO	19187	VI	650,00
1918778K	NA	KIT MACHOIRES GARNIES RVI KERAX 414X220 T088 CO	19187	VI	650,00
1918780	NA	KIT MACHOIRES GARNIES RVI 414X220 T088 CO+ACC	19187	VI	700,00
1918780BOM	NA	KIT MACHOIRES GARNIES 414X220 CO + ACC D7113	19187	VI	
1918780K	NA	KIT MACH. GARN. RVI KERAX 414X220 T088 CO+ACC	19187	VI	700,00
1918780KBOM	NA	KIT MACHOIRES GARN. RT KERAX 414X220 CO + ACC	19187	VI	
1919100AF/700	9,160	GARNITURES FREIN BPW 420X180 NM	19191	VI	125,00
1919200AF/700	9,160	GARNITURES FREIN BPW 420X200 NM RPP19094	19192	VI	121,00
1925510928	NA	JEU GARNITURES 360X170 +1MM QUAL ABEX 928	19255	VI	230,00
19283/28400AF/720	8,420	GARNITURES FREIN SAF 420X178	19283;19284	VI	121,00
19306007000	NA	GARNITURES FREIN DAF 360X170 CO	19306	VI	216,00

REF GIL	Poids	DESIGNATION	OBS	REM	PRIX HT
1935900929	NA	JEU GARNITURES REMORQUE 414X151 8 TROUS Q929 CO	19359	VI	434,00
19369/37000AF/720	9,350	GARNITURES FREIN ROR 419X219	19369;19370	VI	107,00
19384/38500AF/700	8,065	GARNITURES FREIN IVECO, VOLVO 381X178 +TROUS TU	19384;19385	VI	107,00
1938478S	23,000	KIT MACH. GARN. 381X178 ROCKWELL SIMPLEX CO	19384;19385	VI	500,00
1939300AF/710	7,890	GARNITURES FREIN SCANIA 412,8X203	19393	VI	137,00
19396001541	NA	JEU GARNITURES BPW 300X150 CO	19396	VI	304,00
19405001541	NA	JEU GARNITURES SAE 305X200 CO	19405	VI	348,00
1940600929	NA	JEU GARNITURES COLAERT 414X200 CO	19406	VI	322,00
19467/46800AF/710	NA	GARNITURES FREIN VOLVO 393,5X178	19467;19468	VI	164,00
19477/47800AF/700	10,610	GARNITURES FREIN SAF 420X200	19477;19478	VI	131,00
19477/47800AF/720	NA	GARNITURES FREIN SAF 420X200	19477	VI	131,00
19479/48000AF/720	NA	GARNITURES FREIN SAF 367x180	19479;19480	VI	164,00
19490/49100AF/720	NA	GARNITURES FREIN SAF 367x200	19490;19491	VI	164,00
1949200929	NA	JEU GARNITURES VOLVO 381X180 Q.929 CO	19492	VI	350,00
1949400AF/710	6,130	GARNITURES FREIN MERCEDES 163 (410)	19494	VI	100,00
1949500AF/700	6,780	GARNITURES FREIN MERCEDES 183 (410)	19495	VI	88,00
1949500AF/710	6,870	GARNITURES FREIN MERCEDES 183 (410)	19495	VI	100,00
1949510AF/700	7,360	GARNITURES FREIN MERCEDES 183 (410) +1MM	19495	VI	96,00
1949510AF/710	7,360	GARNITURES FREIN MERCEDES 183 (410) +1MM	19495	VI	111,00
1949520AF/700	7,700	GARNITURES FREIN MERCEDES 183 (410) +2MM	19495	VI	107,00
1949578	NA	KIT MACH. GARN. MERCEDES MAN 410X183 T088 CO	19495	VI	530,00
1949600AF/700	8,338	GARNITURES FREIN MERCEDES 223 (410)	19496	VI	100,00
1949600AF/710	8,338	GARNITURES FREIN MERCEDES 223 (410)	19496	VI	109,00
1949610AF/700	8,338	GARNITURES FREIN MERCEDES 223 (410) +1MM	19496	VI	105,00
1949610AF/710	9,000	GARNITURES FREIN MERCEDES 223 (410) +1MM	19496	VI	119,00
1949678	NA	KIT MACH. GARN. MERCEDES MAN 410X223 T088 CO	19496	VI	630,00
1950200412	NA	GARNITURES FREIN RT 381X152 8 TROUS	19502	VI	620,00
1950378	19,600	KIT MACH. GARN. IVECO PERROT 360X170 D7121 CO	19503	VI	490,00
1950380	20,460	KIT MACHOIRS GARN. IVECO PERROT 360X170 CO+ACC	19503	VI	580,00
19515/51600AF/700	4,975	GARNITURES FREIN SAF, KASSBOHRER 300X200	19515;19516	VI	143,00
19515/51600AF/720	4,975	GARNITURES FREIN SAF, KASSBOHRER 300X200	19515;19516	VI	151,00
19517/51800AF/720	3,495	GARNITURES FREIN SAF, TRAILOR 300X150	19517;19518	VI	172,00
1954300929	NA	JEU GARNITURES VOLVO 360X169.5 CO Q929	19543	VI	378,00
1954400929	NA	JEU GARNITURES TRAILOR 356X150 CO Q929	19544	VI	270,00
1954800929	NA	JEU GARNITURES FREIN TITAN 414X175	19548	VI	330,00
19553/55400AF/710	9,970	GARNITURES FREIN IVECO 200 (410)	19553	VI	156,00
19555/55600AF/710	10,105	GARNITURES FREIN IVECO 180 (410)	19555	VI	153,00
19557/60600AF/720	8,794	GARNITURES FREIN SMB 419X203	19557;19606	VI	90,00
19562/56300AF/710	8,380	GARNITURES FREIN VOLVO 393,5X203	19562;19563	VI	119,00
1956200929	NA	JEU GARNITURES VOLVO 393,5X203 CO	19562	VI	378,00
1957300AF/720	4,500	GARNITURES FREIN BPW 300X150	19573	VI	184,00
1957400AF/720	6,085	GARNITURES FREIN BPW 300X200	19574	VI	123,00
19579/58000AF/700	7,130	GARNITURES FREIN MERCEDES 163 (410)	19579;19580	VI	145,00
19579/70600AF/710	6,675	GARNITURES FREIN MERCEDES 163 (410)	19706;19579	VI	166,00
19581/70700AF/710	9,550	GARNITURES FREIN MERCEDES 223 (410)	19707;19581	VI	253,00
1959100AF/720	9,495	GARNITURES FREIN BPW 410X220	19591	VI	219,00
19604/60500AF/700	5,845	GARNITURES FREIN ROR 311X190	19604;19605	VI	107,00
1962000412	NA	JEU GARNITURES RT 325X150 CO	19620	VI	234,00
1962010412	NA	JEU GARNITURES RT 325X150 +1MM	19620	VI	260,00
1962200412	NA	JEU GARNITURES RT 394X152 CO	19622	VI	218,00
1967210929	NA	JEU GARNITURES FRUEHAUF 419X150 +1MM	19672	VI	323,00
19687001549	NA	JEU GARNITURES GRUE 500X160 8 T. CO BERL 1549	19687	VI	480,00
19687002200	NA	JEU GARNITURES GRUE 500X160 8 TROUS CO + RIVETS	19687	VI	440,00
19690001549	NA	JEU GARNITURES GRUE 500X180 8 T.S CO BERL 1549	19690	VI	460,00
19690002200	NA	JEU GARNITURES GRUE 500X180 8 TROUS CO + RIVETS	19690	VI	440,00
1969000AF/720	11,743	GARNITURES FREIN GRUE 500X180	19690	VI	327,00
19709003658	NA	JEU GARNITURES RT 325X150 FER3658 CO	19709	VI	280,00
1971400AF/710	9,270	GARNITURES FREIN IVECO 410X180 ROCKWELL 2	19714;19715;19556	VI	188,00

REF GIL	Poids	DESIGNATION	OBS	REM	PRIX HT
1971478	NA	KIT MACH. GARN. IVECO 410X180 ROC. SIMPLEX CO	19714;19556;19715	VI	780,00
1971480	NA	KIT MACH. GARN. IVECO 410X180 ROC. SIMP. CO+ACC	19714;19556;19715	VI	880,00
1971600AF/710	10,460	GARNITURES FREIN IVECO 410X200 ROCKWELL 2	19553;19716;19717	VI	190,00
1971678	NA	KIT MACH. GARN. IVECO 410X200 ROC. SIMPLEX CO	19716;19553;19717	VI	780,00
1971680	NA	KIT MACH. GARN. IVECO 410X200 ROC. SIMP. CO+ACC	19716;19553;19717	VI	880,00
19718/71900AF/700	NA	GARNITURES FREIN SMB 360X200	19718;19719	VI	123,00
19723001549	NA	JEU GARNITURES GRUE 410X180 8 T. CO BERAL 1549	19723	VI	440,00
19723002200	NA	JEU GARNITURES GRUE 410X180 8 TROUS CO + RIVETS	19723	VI	380,00
1974200929	NA	JEU GARNITURES RT 381X152 12 TROUS CO	19742	VI	590,00
1974210929	NA	JEU GARNITURES RT 381X152 12 TROUS + 1MM	19742	VI	656,00
19762/76300AF/700	NA	GARNITURES FREIN SAE DUPILLIER 305X200	19762;19763	VI	117,00
19783007000	NA	JEU GARNITURES ROR 311X177 CO + RIVETS	19783	VI	190,00
19799/80000AF/710	10,440	GARNITURES FREIN VOLVO 393,5X254	19799;19800	VI	286,00
1982100929	NA	JEU GARNITURES IVECO 325X160 CO 929	19821	VI	310,00
19844/84520AF/710	4,920	GARNITURES FREIN MERCEDES 364X160	19844;19845	VI	145,00
19847/84800AF/700	9,000	GARNITURES FREIN EVOBUS 410X220	19847;19848	VI	172,00
19847/84800AF/710	9,000	GARNITURES FREIN EVOBUS 410X220	19847;19848	VI	194,00
19849/85000AF/710	6,582	GARNITURES FREIN EVOBUS 410X160	19849;19850	VI	162,00
1985800928	NA	JEU GARNITURES LECINENA 315X200 CO	19858	VI	285,00
19888/88900AF/710	7,330	GARNITURES FREIN DAF 420X240	19888;19889	VI	184,00
19890/89100AF/710	8,440	GARNITURES FREIN DAF 420X200	19890;19891	VI	145,00
19892/89300AF/700	7,635	GARNITURES FREIN SAF 355X200	19892;19893	VI	182,00
19900/90100AF/710	6,380	GARNITURES FREIN DAF 420X150	19900;19901	VI	109,00
19902/90300AF/700	7,750	GARNITURES FREIN BPW 360X200	19902;19903	VI	86,00
19908/90900AF/700	7,850	GARNITURES FREIN ROR 350X200	19908;19909	VI	121,00
19914/91500AF/710	10,120	GARNITURES FREIN DAF 420X240	19914;19915	VI	264,00
1992800929	NA	JEU GARNITURES NISSAN 360X170 CO Q929	19928	VI	350,00
1993100AF/710	5,125	GARNITURES FREIN SCANIA 178 (412,8)	19931	VI	123,00
1993200AF/710	6,220	GARNITURES FREIN SCANIA 203 (412,8)	19932	VI	135,00
1993280	NA	KIT MACH. GARN. SCANIA 412,8X203 T088 CO + ACC	19932	VI	660,00
1993300AF/710	7,930	GARNITURES FREIN SCANIA 254 (412,8)	19933	VI	145,00
1993380	NA	KIT MACH. GARN. SCANIA 412,8X254 T088 CO + ACC	19933	VI	730,00
1993400AF/700	7,389	GARNITURES FREIN RVI 150 (414) NM	19934	VI	94,00
1993400AF/710	7,465	GARNITURES FREIN RVI 150 (414) NM	19934	VI	102,00
1993410AF/700	7,465	GARNITURES FREIN RVI 150 (414) NM +1MM	19934	VI	102,00
1993478	NA	KIT MACH. GARNIES RT PREMIUM 414X175 T088 CO	19934	VI	530,00
1993478K	NA	KIT MACHOIRES GARNIES RT KERAX 414X175 T088 CO	19934	VI	560,00
1993480	NA	KIT MACH. GARN. RT PREMIUM 414X175 T088 CO+ACC	19934	VI	630,00
1993480K	NA	KIT MACH. GARN. RT KERAX 414X175 T088 CO + ACC	19934	VI	660,00
1993500AF/700	8,985	GARNITURES FREIN RVI 175 (414) NM	19935	VI	105,00
1993500AF/710	8,165	GARNITURES FREIN RVI 175 (414) NM	19935	VI	115,00
1993510AF/700	9,600	GARNITURES FREIN RVI 175 (414) NM +1MM	19935	VI	117,00
1993520AF/700	10,220	GARNITURES FREIN RVI 175 (414) NM +2MM	19935	VI	127,00
1993578	NA	KIT MACH. GARNIES RT PREMIUM 414X175 T088 CO	19935	VI	530,00
1993578K	NA	KIT MACHOIRES GARNIES RT KERAX 414X175 T088 CO	19935	VI	560,00
1993580	NA	KIT MACH. GARN. RT PREMIUM 414X175 T088 CO+ACC	19935	VI	630,00
1993580K	NA	KIT MACH. GARN. RT KERAX 414X175 T088 CO + ACC	19935	VI	660,00
1994100AF/710	6,517	GARNITURES FREIN VOLVO 150 Z (410)	19941	VI	82,00
1994180	NA	KIT MACHOIRES GARNIES VOLVO 410X150 T088 CO	19941	VI	450,00
1995200AF/700	6,235	GARNITURES FREIN BPW 360X160	19952	VI	160,00
19975007000	NA	JEU GARNITURES VOLVO 393.7X230 CO +RIVETS	19975	VI	420,00
1999600412	NA	GARNITURES FREIN COLAERT 305X200 CO	19996	VI	348,00
29013FLE986	3,980	PLAQUETTES FREIN RT SEE PAM	29013	VI	113,00
29030KFLE930	11,410	PLAQUETTES FREIN D3	29030	VI	153,00
29032KFLE1749	6,110	PLAQUETTES FREIN IVECO BENDIX ADB3700	29032	VI	151,00
29039FLE986	4,300	PLAQUETTES FREIN VOLVO MERITOR 2X68	29039	VI	105,00
29076FLE1749	2,520	PLAQUETTES FREIN MERCEDES VOLKSWAGEN	29076	VI	60,00
29090KFLE1931	10,770	PLAQUETTES FREIN RT MERITOR R90 USAGE SEVERE	29090	VI	204,00

REF GIL	Poids	DESIGNATION	OBS	REM	PRIX HT
29093FLE925	11,560	PLAQUETTES FREIN KN SB6 (FONTE) R90	29093, 29095	VI	170,00
29095FLE929	8,960	PLAQUETTES FREIN KN SB6 (ACIER) R90	29093, 29095	VI	153,00
29122FLE930	4,300	PLAQUETTES FREIN IVECO	29122	VI	80,00
29123FLE987	1,800	PLAQUETTES FREIN IVECO	29123	VI	54,00
29125KFLE930	11,100	PLAQUETTES FREIN D-DUCO	29125	VI	172,00
29126KFLE1749	8,070	PLAQUETTES FREIN PAN 19-1 DAF SAF	29126, 29159	VI	174,00
29142KFLE986	8,210	PLAQUETTES FREIN DAF RT PAN 19-2	29142;29141	VI	188,00
29143KFLE1749	11,150	PLAQUETTES FREIN SAE,SAF,SCANIA,SMB HALDEX DB22	29143,29185	VI	182,00
29173KFLE1749	9,530	PLAQUETTES FREIN ELSA 225-1	29173, 29203	VI	153,00
29173KFLE1931	9,530	PLAQUETTES FREIN ELSA 225-1 USAGE SEVERE	29173, 29203	VI	180,00
29173KFLE930	9,530	PLAQUETTES FREIN ELSA 225-1	29173, 29203	VI	153,00
98032100	0,044	TEMOIN USURE IVECO PERROT (FAT)	19091;19099	VI	50,00
98032200	0,083	TEMOIN USURE IVECO ROCKWELL (FAT)	19553;19555;19714;19716;	VI	36,90
A4667	NA	MACHOIRE NUE RT JP 393,7X152	19622	VI	139,00
AB299939	0,460	KIT RESSORT RT 355X100		VI	123,00
AB312498510	9,320	KIT MACHOIRES NUES 325X150 HYDRAULIQUE		VI	670,00
AB316811	NA	KIT REPOSE SEGMENT 325X150 (ROUE)		VI	74,00
AB316819	NA	KIT RATRAPAGE GAUCHE 325X150		VI	182,00
AB316820	NA	KIT RATRAPAGE DROIT 325X150		VI	182,00
AB327073	NA	ENSEMBLE PLATEAU GAUCHE SG3 AR		VI	610,00
AB327074	3,000	ENSEMBLE PLATEAU DROIT SG3 AR		VI	610,00
AB330148	NA	COLLECTION DE RESSORT 325X150		VI	90,00
AB330149	NA	KIT RESSORT RT 355X100		VI	123,00
AB330160	NA	ENSEMBLE BIELETTE GAUCHE		VI	150,00
AB330161	NA	ENSEMBLE BIELETTE DROIT		VI	150,00
AB331464	2,500	MACHOIRE NUE RT 355X100		VI	162,00
AB331468	2,500	MACHOIRE NUE RT 355X100		VI	162,00
AB332054	0,250	KIT RESSORT TRM 2000		VI	112,00
AB332059	NA	COLLECTION DE RATRAPAGE AUTO POUR ROUE DROITE		VI	90,00
AB332124	NA	COLLECTION DE RESSORT 355X100		VI	82,00
AB337220	2,500	MACHOIRE NUE RT 360X170	19255;19259	VI	150,00
AB337276	3,220	ECARTEUR FREIN COIN RT 360X170-310X125-325X150	B357647;19255;19709;17352	VI	452,00
AB338608	0,600	COLLECTION DE RESSORT 360X170	19255;19259	VI	98,00
AB350891	8,860	MACHOIRE NUE RT 325X150	19709	VI	139,00
AB350929	2,500	MACHOIRE NUE RT 310X125	17352	VI	135,00
AC0001	0,132	KIT D'AXE TRANSVERSAL	19068, 19071, 19090	VI	31,00
AC0002	0,185	KIT DE TIGE MANUELLE	19068, 19071, 19090	VI	46,00
AC0003	0,045	KIT DE VERROUILLAGE DE REGLEUR	19068, 19071, 19090	VI	14,00
AC0004	3,465	KIT DE VERROUILLAGE DE REGLEUR	19068, 19071, 19090	VI	14,00
AC0005	0,851	KIT DE REGLAGE DROIT AUTOMATIQUE	19068, 19071, 19090	VI	90,00
AC0006	0,851	KIT DE REGLAGE GAUCHE AUTOMATIQUE	19068, 19071, 19090	VI	90,00
AC0007	0,068	JAMBE	19068, 19071, 19090	VI	14,00
AC0008	0,050	VIS NOYEE	19068, 19071, 19090	VI	5,00
AC0009	0,107	PLAQUE COUVERCLE	19068, 19071, 19090	VI	11,00
AC0010	0,143	PINION GAUCHE	19068, 19071, 19090	VI	56,00
AC0011	0,143	PINION DROIT	19068, 19071, 19090	VI	56,00
AC0012	0,060	JOINT	19068, 19071, 19090	VI	1,50
AC0013	0,700	ANNEAU ELASTIQUE (SEGMENT)	19068, 19071, 19090	VI	22,00
AC0014	0,002	CACHE - POUSSIERE	19068, 19071, 19090	VI	16,00
AC0015	0,045	AGRAFE À RESSORT	19068, 19071, 19090	VI	10,00
AC0016	0,080	PION DE BUTEE	19068, 19071, 19090	VI	13,00
AC0017	0,003	CLIP (CLIP)		VI	3,00
AC0018	NA	GALET	19934, 19935, 19187	VI	8,00
AC0019	NA	AXE DE GALET	19934, 19935, 19187	VI	8,00
AC0020	NA	AXE DE MACHOIRE	19934, 19935, 19187	VI	29,00
AC0021	NA	ROTULE 42X62X25	19934, 19935, 19187	VI	17,00
AC0023	0,174	TÊTE DE REGLAGE	19109;19116;	VI	40,00
AC0024	0,120	MANCHON DE BOULON DE RÉGLAGE	19109;19116;	VI	40,00

REF GIL	Poids	DESIGNATION	OBS	REM	PRIX HT
AC0025	0,550	PLONGEUR D'ECARTEMENT GAUCHE	19109;19116;	VI	40,00
AC0026	0,550	PLONGEUR D'ECARTEMENT DROIT	19109;19116	VI	40,00
AC0027	0,240	AJUSTEMENT DU PLONGEUR D'ECARTEMENT	19109;19116;19714;19716;	VI	40,00
AC0028	0,150	JOINT DU PLONGEUR D'ECARTEMENT	19109;19116;	VI	9,00
AC0029	0,020	JOINT DE TÊTE DE RÉGLAGE	19109;19116;19714;19716;	VI	6,00
AC0030	0,050	VIS GUIDE	19109;19116;	VI	9,00
AC0031	0,030	ENSEMBLE CLIQUET DE GUIDAGE	19109;19116;	VI	14,00
AC0032	0,290	COIN ASSEMBLE	19109;19116;19714;19716;	VI	55,00
AC0033	0,070	GRAISSE	19109;19116;19714;19716;	VI	5,90
AC0034	0,120	MANCHON DE BOULON DE RÉGLAGE	19553;19555;19714;19716;	VI	40,00
AC0035	0,030	ENSEMBLE CLIQUET DE GUIDAGE	19553;19555;19714;19716;	VI	14,00
AC0036	0,250	KIT PLONGEUR D'ANCRAGE GAUCHE	19553;19555;19714;19716;	VI	55,00
AC0037	0,250	KIT PLONGEUR D'ANCRAGE DROIT	19553;19555;19714;19716;	VI	55,00
AC0038	0,290	ENSEMBLE CLIQUET DE GUIDAGE	19553;19555;19714;19716;	VI	55,00
AC0039	0,025	PION DE MAINTIEN RESSORT SCANIA	19931;19932;19933	VI	4,00
ACK002	0,250	KIT CLIP DE FIXATION		VI	39,00
ACK003	0,150	KIT CLIP DE FIXATION MACHOIRES IVECO STOPMASTER	19109;19116;19714;19716;	VI	16,00
ACK004	0,250	KIT CLIP DE FIXATION		VI	30,00
ACK005	NA	KIT COIN COMPLET		VI	368,00
ACK006	NA	COMPLETE ADJUSTER KITS		VI	368,00
ACK007	NA	KIT COIN SIMPLIFIE		VI	143,00
ACK008	0,700	KIT DE REGLAGE SIMPLIFIE		VI	235,00
ACK009	1,250	KIT DE REGLAGE COMPLET		VI	217,00
ACK010	NA	KIT DE REGLAGE COMPLET		VI	235,00
ACK011	0,580	KIT DE REGLAGE SIMPLIFIE		VI	190,00
ACK012	0,700	KIT DE REGLAGE SIMPLIFIE		VI	150,00
ACK013	0,610	KIT DE REGLAGE SIMPLIFIE		VI	211,00
ACK014	0,350	KIT JOINT D'ETANCHEITE		VI	170,00
ACK015	1,100	KIT PLONGEUR D'ANCRAGE		VI	200,00
ACK016	1,110	KIT PLONGEUR D'ANCRAGE		VI	200,00
ACK019	0,250	KIT SABOT ET GARNITURE 2 MM SURDIMENSIONNE		VI	105,00
ACK020	0,500	KIT RESSORT DE RAPPEL		VI	105,00
ACK021	0,340			VI	24,00
APF001	0,340	AXE POINT FIXE	19934, 19935, 19187	VI	6,00
APF001/1	0,060	GOUPILLE MECANIMBUS	19934, 19935, 19187	VI	1,20
APF001/1AXLE	NA	KIT AXES POINTSFIXE (AXE,BAGUE,JOINT,GOUPILLE)	19934, 19935, 19187	VI	40,00
APF001/2	0,010	JONT TORIQUE	19934, 19935, 19187	VI	1,20
APF001/3	0,260	BAGUE POINT FIXE	19934, 19935, 19187	VI	7,00
APF002	1,450	KIT AXE POINT FIXE		VI	40,00
AXE001	NA	AXE RESSORT RT	19934, 19935, 19187	VI	3,20
AXE002	NA	AXE RESSORT RT	19934, 19935, 19187	VI	3,20
AXE003	NA	AXE DE PLAQUETTE Ø8 FREIN 22.5 SEE PAM		VI	65,00
AXE004	NA	AXE DE PLAQUETTE Ø10 FREIN 22.5 SEE PAM		VI	94,00
BE0001	0,860	BAGUE D'ETANCHEITE 120X160X15	19934, 19935, 19187	VI	27,00
BE0002	NA	BAGUE D'ETANCHEITE 185X210X13		VI	27,00
BE0003	NA	BAGUE D'ETANCHEITE 110X170X15 DL NITRILE		VI	27,00
CAC001	NA	CACHE ANTI-POUSSIÈRE (SACHET DE 10) MERITOR		VI	37,90
CAC002	NA	KIT COMPLET REGLAGE CAME Z	17992;19068;19071;19090;19941	VI	220,00
CAC003	NA	KIT COMPLET PINION G/D CAME Z	17992;19068;19071;19090;19941	VI	220,00
CAC004	NA	KIT ECROUS (10) DE REGLAGE KNORR		VI	16,00
CAC005	NA	KIT AXES DE GUIDAGE ET ETANCHEITE KNORR		VI	67,00
CAC006	NA	REGLEUR COMPLET TETE HEXAGONALE KNORR		VI	50,00
CAC007	NA	KIT AXES DE GUIDAGE ET ETANCHEITE KNORR		VI	67,00
CAC008	NA	KIT POUSSOIRS ET SOUFFLETS KNORR		VI	32,00
CAC009	NA	KIT POUSSOIRS ET SOUFFLETS KNORR		VI	32,00
CAC010	NA	KIT AXES DE GUIDAGE ET ETANCHEITE KNORR		VI	62,00
CAC011	NA	KIT CACHE-POUSSIERES MERITOR		VI	14,00
CAC012	NA	KIT AXES DE GUIDAGE ET ETANCHEITE MERITOR		VI	79,00

REF GIL	Poids	DESIGNATION	OBS	REM	PRIX HT
CAC013		NA KIT AXES DE GUIDAGE ET ETANCHEITE MERITOR		VI	69,00
CAC014		NA KIT AXES DE GUIDAGE ET ETANCHEITE MERITOR		VI	98,00
CAC015		NA KIT AXES DE GUIDAGE ET ETANCHEITE MERITOR		VI	87,00
CAC016		NA KIT AXES DE GUIDAGE ET ETANCHEITE MERITOR		VI	86,00
CAC017		NA KIT AXES DE GUIDAGE ET ETANCHEITE WABCO		VI	56,00
CAC018		NA KIT AXES DE GUIDAGE ET ETANCHEITE WABCO		VI	102,00
CAC019		NA KIT AXES DE GUIDAGE ET ETANCHEITE WABCO		VI	67,00
CAC020		NA PLAQUE DE COMPRESSION G PAN 17 WABCO		VI	58,00
CAC021		NA PLAQUE DE COMPRESSION D PAN 17 WABCO		VI	58,00
CAC022		NA PLAQUE DE COMPRESSION G PAN 19 WABCO		VI	58,00
CAC023		NA PLAQUE DE COMPRESSION D PAN 19 WABCO		VI	58,00
CAC024		NA KIT AXES DE GUIDAGE ET ETANCHEITE KNORR		VI	62,00
CAC025		NA KIT AXES DE GUIDAGE ET ETANCHEITE KNORR		VI	62,00
CAC026		NA KIT AXES DE GUIDAGE ET ETANCHEITE KNORR		VI	62,00
CAC027		NA KIT AXES DE GUIDAGE ET ETANCHEITE MERITOR		VI	132,00
CAC028		NA KIT AXES DE GUIDAGE ET ETANCHEITE MERITOR		VI	117,00
CAC032		NA KIT REPARATION COIN GAUCHE COMPLET IVECO DUPLEX	2 KITS POUR 1 ROUE	VI	198,00
CAC033		NA KIT REPARATION COIN DROIT COMPLET IVECO DUPLEX	2 KITS POUR 1 ROUE	VI	198,00
CAC034		NA KIT REP.N COIN GAUCHE COMPLET IVECO SIMPLEX		VI	290,00
CAC035		NA KIT REPARATION COIN DROIT COMPLET IVECO SIMPLEX		VI	290,00
CAM001	4,000	CAME FREIN GAUCHE Z 415 MM		VI	388,00
CAM002	4,000	CAME FREIN DROIT Z 415 MM		VI	388,00
CAM003		NA CAME FREIN GAUCHE		VI	372,00
CAM004		NA CAME FREIN DROIT		VI	372,00
CAM005		NA CAME FREIN GAUCHE Z 230 MM		VI	388,00
CAM006		NA CAME FREIN DROIT Z 230 MM		VI	388,00
CAM007	2,960	CAME Z 285 MM GAUCHE		VI	388,00
CAM008	2,960	CAME Z 285 MM DROIT		VI	388,00
CAM009	4,200	CAME Z 435 MM GAUCHE		VI	388,00
CAM010	4,200	CAME Z 435 MM DROIT		VI	388,00
CFM001	0,500	CABLE FREIN A MAIN RT MASCOTT GAUCHE		VI	28,00
CFM002	0,480	CABLE FREIN A MAIN RT MASCOTT DROIT		VI	28,00
CFM003	0,500	CABLE FREIN A MAIN RT B90		VI	48,00
CFM004	0,460	CABLE FREIN A MAIN RT MASCOTT GD		VI	30,00
CFM005	0,640	CABLE FREIN A MAIN IVECO DAILY		VI	46,00
CFM006	0,800	CABLE FREIN A MAIN IVECO DAILY		VI	46,00
CFM007	0,680	CABLE FREIN A MAIN IVECO DAILY		VI	30,00
CFM008	0,440	CABLE FREIN A MAIN IVECO DAILY		VI	36,00
CFM009	0,440	CABLE FREIN A MAIN IVECO DAILY		VI	34,00
CFM010	0,480	CABLE FREIN A MAIN IVECO DAILY		VI	24,00
CFM011	0,420	CABLE FREIN A MAIN IVECO DAILY		VI	18,00
CFM012	0,420	CABLE FREIN MAIN MERCEDES SPRINTER VW CRAFTER		VI	30,00
CFM013	0,420	CABLE FREIN MAIN MERCEDES SPRINTER VW CRAFTER		VI	30,00
CFM014	0,420	CABLE FREIN A MAIN MERCEDES SPRINTER		VI	30,00
CFM015	0,420	CABLE FREIN MAIN MERCEDES SPRINTER VW CRAFTER		VI	30,00
CFM016	0,420	CABLE FREIN A MAIN MERCEDES SPRINTER		VI	30,00
CFM017	0,420	CABLE FREIN A MAIN NISSAN CABSTAR E GAUCHE		VI	44,00
CFM018	0,420	CABLE FREIN A MAIN NISSAN CABSTAR E DROIT		VI	44,00
CFM019	0,400	CABLE FREIN A MAIN NISSAN CABSTAR E GAUCHE		VI	44,00
CFM020	0,400	CABLE FREIN A MAIN NISSAN CABSTAR E DROIT		VI	44,00
CFM021	0,400	CABLE FREIN A MAIN NISSAN CABSTAR E		VI	44,00
CFM022	0,400	CABLE FREIN A MAIN NISSAN CABSTAR E		VI	44,00
CFM024	0,380	CABLE FREIN A MAIN NISSAN CABSTAR GAUCHE		VI	44,00
CFM025	0,380	CABLE FREIN A MAIN NISSAN CABSTAR DROIT		VI	44,00
COJ2222429	1,000	VALVE PROTECTION		VI	184,00
COJ2320100		NA CORRECTEUR FREIN	BR4352	VI	305,00
COJ4230313	3,460	LEVIER REGLEUR AUTOMATIQUE MB		VI	90,00
COJ4230314	3,440	LEVIER REGLEUR AUTOMATIQUE MB		VI	90,00

REF GIL	Poids	DESIGNATION	OBS	REM	PRIX HT
COJ4230395	3,480	LEVIER REGLEUR AUTOMATIQUE BPW		VI	90,00
COJ4230400	3,180	LEVIER REGLEUR AUTOMATIQUE MB		VI	90,00
COJ4230704	3,420	LEVIER REGLEUR AUTOMATIQUE DAF		VI	90,00
COJ4230705	3,380	LEVIER REGLEUR AUTOMATIQUE DAF		VI	90,00
COJ4230719	3,640	LEVIER REGLEUR AUTOMATIQUE DAF		VI	90,00
COJ4230720	3,400	LEVIER REGLEUR AUTOMATIQUE DAF		VI	90,00
COJ4230760	3,620	LEVIER REGLEUR AUTOMATIQUE MB		VI	90,00
COJ4230761	3,580	LEVIER REGLEUR AUTOMATIQUE MB		VI	90,00
COJ4230811	3,340	LEVIER REGLEUR AUTOMATIQUE SCANIA		VI	90,00
COJ4230891	3,180	LEVIER REGLEUR AUTOMATIQUE VOLVO		VI	90,00
COJ4230892	3,240	LEVIER REGLEUR AUTOMATIQUE VOLVO		VI	90,00
COJ4230897	3,540	LEVIER REGLEUR AUTOMATIQUE		VI	90,00
COJ4231081	3,500	LEVIER REGLEUR AUTOMATIQUE RVI		VI	90,00
COJ4231082	3,500	LEVIER REGLEUR AUTOMATIQUE RVI		VI	90,00
COJ4231083	NA	LEVIER REGLEUR AUTOMATIQUE RVI		VI	90,00
COJ4231158	3,920	LEVIER REGLEUR AUTOMATIQUE SCANIA		VI	90,00
COJ4231159	3,780	LEVIER REGLEUR AUTOMATIQUE SCANIA		VI	90,00
COJ4231235	3,480	LEVIER REGLEUR AUTOMATIQUE MAN DROIT		VI	90,00
COJ4231236	3,540	LEVIER REGLEUR AUTOMATIQUE MAN GAUCHE		VI	90,00
COJ4231240	3,320	LEVIER REGLEUR AUTOMATIQUE MAN		VI	90,00
COJ4231241	3,480	LEVIER REGLEUR AUTOMATIQUE MAN		VI	90,00
COJ4231242	3,160	LEVIER REGLEUR AUTOMATIQUE MAN		VI	90,00
COJ4231293	3,720	LEVIER REGLEUR AUTOMATIQUE RVI DROIT		VI	90,00
COJ4231294	3,540	LEVIER REGLEUR AUTOMATIQUE RVI GAUCHE		VI	90,00
COJ4231295	3,700	LEVIER REGLEUR AUTOMATIQUE RVI		VI	90,00
COJ4231296	3,540	LEVIER REGLEUR AUTOMATIQUE RVI		VI	90,00
COJ4231303	NA	LEVIER REGLEUR AUTO. RT 28 CAN. DROIT PREMIUM	72997	VI	90,00
COJ4231304	NA	LEVIER REGLEUR AUTO. RT 28 CAN. GAUCHE REMIUM	72998	VI	90,00
COJ4231309	3,780	LEVIER REGLEUR AUTOMATIQUE RVI		VI	90,00
COJ4231310	3,760	LEVIER REGLEUR AUTOMATIQUE RVI		VI	90,00
COJ4231381	3,740	LEVIER REGLEUR AUTOMATIQUE IRISBUS		VI	90,00
COJ4231382	3,420	LEVIER REGLEUR AUTOMATIQUE IRISBUS		VI	90,00
COJ4231383	3,780	LEVIER REGLEUR AUTOMATIQUE SCANIA		VI	90,00
COJ4231384	3,580	LEVIER REGLEUR AUTOMATIQUE SCANIA		VI	90,00
COJ4231464	3,480	LEVIER REGLEUR AUTO. RT PREMIUM AR 27 CAN.	79683C	VI	90,00
COJ4231465	3,480	LEVIER REGLEUR AUTO. RT PREMIUM AR 27 CAN.	79684C	VI	90,00
COJ5031001	3,120	LEVIER REGLEUR AUTOMATIQUE MERCEDES		VI	140,00
COJ5031002	3,080	LEVIER REGLEUR AUTOMATIQUE MERCEDES		VI	140,00
COJ5031003	3,200	LEVIER REGLEUR AUTOMATIQUE MERCEDES	REF HALDEX 80008	VI	140,00
COJ5031004	3,220	LEVIER REGLEUR AUTOMATIQUE MERCEDES	REF HALDEX 80009	VI	140,00
COJ5031010	NA	LEVIER REGLEUR AUTOMATIQUE		VI	140,00
COJ5781001	NA	LEVIER REGLEUR AUTOMATIQUE	REF HALDEX 80023	VI	140,00
COJ6002202	NA	ARTICULATION DROITE 8 MM		VI	9,00
COJ6002204	NA	ARTICULATION DROITE 6 MM		VI	6,00
COR219	0,340	CORRECTEUR RT SG2, SG3	L631219	VI	508,00
COR300	0,380	CORRECTEUR IVECO DAILY		VI	255,00
COR301	0,360	CORRECTEUR IVECO EUROARGO ZETA		VI	76,00
COR302	0,380	CORRECTEUR IVECO DAILY		VI	174,00
COR303	0,380	CORRECTEUR IVECO DAILY		VI	113,00
COR304	0,380	CORRECTEUR IVECO DAILY		VI	296,00
COR305	0,380	CORRECTEUR IVECO DAILY		VI	62,00
COR306	NA	CORRECTEUR NISSAN CABSTAR		VI	SD
COR307	NA	CORRECTEUR NISSAN MODIFIE		VI	640,00
COR386	NA	CORRECTEUR TRM2000		VI	1 600,00
CR0003	NA	CYLINDRE ROUE AV TRACTION 11		VI	71,00
CR0004	NA	CYLINDRE ROUE AR TRACTON 11		VI	71,00
CR0018	0,070	CYLINDRE ROUE	L621018	VI	186,00
CR0019	NA	CYLINDRE ROUE	L621019	VI	186,00

REF GIL	Poids DESIGNATION	OBS	REM	PRIX HT
CR0079	0,660 CYLINDRE ROUE	L621079	VI	247,00
CR0080	0,660 CYLINDRE ROUE GOELETTE AV	L621080	VI	217,00
CR0086	0,660 CYLINDRE ROUE GOELETTE AR	L621086	VI	310,00
CR0106	NA CYLINDRE ROUE MANITOU	L621106	VI	249,00
CR0135	NA CYLINDRE ROUE DIA 16	L621135	VI	119,00
CR0310	1,520 CYLINDRE ROUE RT DIA 38,1	L621310	VI	321,00
CR0342	1,760 CYLINDRE ROUE RT	L621342	VI	376,00
CR0351	NA CYLINDRE ROUE RT	L621351	VI	394,00
CR0366	0,920 CYLINDRE ROUE RT DIA 38,1	L621366	VI	234,00
CR0367	1,670 CYLINDRE ROUE RT DIA 44,45	L621367	VI	72,00
CR0387	NA CYLINDRE ROUE	L621387	VI	SD
CR0388	NA CYLINDRE ROUE	L621388	VI	SD
CR0414	NA CYLINDRE ROUE D31,75 IVECO 109.14		VI	172,00
CR0420	0,560 CYLINDRE ROUE IVECO		VI	70,00
CR0526	NA CYLINDRE ROUE RT	L621526	VI	SD
CR0527	NA CYLINDRE ROUE RT	L621527	VI	SD
CR0529	NA CYLINDRE ROUE RT	L621529	VI	SD
CR0539	2,200 CYLINDRE ROUE RT	L621539	VI	164,00
CR0541	NA CYLINDRE ROUE RT	L621541	VI	SD
CR0546	2,500 CYLINDRE ROUE RT	L621546	VI	164,00
CR0549	0,580 CYLINDRE ROUE RT DIA 28,57	L621549	VI	66,00
CR0550	0,620 CYLINDRE ROUE RT DIA 28,57	L621550	VI	66,00
CR0571	NA CYLINDRE ROUE RT	L621571	VI	SD
CR0581	0,360 CYLINDRE ROUE DB		VI	54,00
CR0618	0,640 CYLINDRE ROUE NISSAN		VI	54,00
CR0620	NA CYLINDRE ROUE IVECO DIA 44,45	FIXATION TRANSVERSALE	VI	233,00
CR0677	NA CYLINDRE ROUE RT	L621677	VI	SD
CR0678	NA CYLINDRE ROUE RT	L621678	VI	SD
CR0690	0,620 CYLINDRE ROUE RT	L621690	VI	66,00
CR0748	0,520 CYLINDRE ROUE DB		VI	76,00
CR0827	0,660 CYLINDRE ROUE RT	L621827	VI	68,00
CR0835	NA CYLINDRE ROUE RT TRM AR G	L621835	VI	448,00
CR0836	NA CYLINDRE ROUE RT TRM AR D	L621836	VI	448,00
CR0837	NA CYLINDRE ROUE RT TRM AV G	L621837	VI	411,00
CR0838	NA CYLINDRE ROUE RT TRM AV D	L621838	VI	411,00
CR0891	2,200 CYLINDRE ROUE RT	L621891	VI	164,00
CR0896	0,720 CYLINDRE ROUE RT	L621896	VI	68,00
CR0918	0,700 CYLINDRE ROUE RT	L621918	VI	68,00
CR0925	2,240 CYLINDRE ROUE RT	L621925	VI	328,00
CR0926	2,240 CYLINDRE ROUE RT	L621926	VI	328,00
CR0928	2,000 CYLINDRE ROUE RT	L621928	VI	230,00
CR0929	2,000 CYLINDRE ROUE RT	L621929	VI	230,00
CR0930	1,900 CYLINDRE ROUE RT	L621930	VI	164,00
CR0931	1,900 CYLINDRE ROUE RT	L621931	VI	164,00
CR0932	2,360 CYLINDRE ROUE RT	L621932	VI	334,00
CR0933	2,340 CYLINDRE ROUE RT	L621933	VI	334,00
CR0934	2,340 CYLINDRE ROUE RT	L621934	VI	344,00
CR0935	2,260 CYLINDRE ROUE RT	L621935	VI	344,00
CR0940	2,280 CYLINDRE ROUE RT	L621940	VI	440,00
CR0941	2,280 CYLINDRE ROUE RT	L621941	VI	440,00
CR1002	0,380 CYLINDRE ROUE DAF IVECO		VI	92,00
CR1003	0,380 CYLINDRE ROUE DAF IVECO		VI	92,00
CR1004	0,920 CYLINDRE ROUE NISSAN		VI	192,00
CR1005	0,360 CYLINDRE ROUE IVECO		VI	104,00
CR1006	0,560 CYLINDRE ROUE IVECO		VI	72,00
CR1007	0,680 CYLINDRE ROUE IVECO		VI	72,00
CR1010	0,688 CYLINDRE ROUE IVECO		VI	89,00
CR1011	0,580 CYLINDRE ROUE IVECO DIA 25,4		VI	72,00

REF GIL	Poids	DESIGNATION	OBS	REM	PRIX HT
CR1012	0,620	CYLINDRE ROUE IVECO DIA 50,8		VI	168,00
CR1014	2,100	CYLINDRE ROUE IVECO DIA 50,8		VI	168,00
CR1015	0,622	CYLINDRE ROUE IVECO ZETA AV DIA 26,99		VI	72,00
CR1016	0,570	CYLINDRE ROUE IVECO LUPETO DIA 22,22		VI	88,00
CR1017	0,841	CYLINDRE ROUE IVECO ZETA DIA 31,75		VI	168,00
CR1018	2,100	CYLINDRE ROUE IVECO DIA 50,8		VI	168,00
CR1019	0,580	CYLINDRE ROUE IVECO ZETA DIA 23,81		VI	72,00
CR1020	0,580	CYLINDRE ROUE IVECO ZETA DIA 28,57		VI	124,00
CR1021	0,580	CYLINDRE ROUE NISSAN DIA 25,4		VI	97,00
CR1022		NA CYLINDRE ROUE NISSAN DIA 28,57		VI	114,00
CR1023		NA CYLINDRE ROUE IVECO DIA 19,05		VI	52,00
CRB143	2,060	CYLINDRE ROUE RT	L624143	VI	SD
CRB144		NA CYLINDRE ROUE RT	L624144	VI	SD
CRB147	2,040	CYLINDRE ROUE RT	L624147	VI	SD
CRB148	1,940	CYLINDRE ROUE RT	L624148	VI	704,00
CRB152	1,500	CYLINDRE ROUE PEUGEOT D4A	L624152, 212022B	VI	248,00
CRB157	0,860	CYLINDRE ROUE RT	L624157	VI	68,00
CRB190	1,000	CYLINDRE ROUE RT	L624190	VI	126,00
CVL3098075		NA JEU DE GARNITURES SG2 310X80 +RIVETS		VI	258,00
CVL380220KINGLONG		NA JEU GARNITURES KING LONG 380X220 CO		VI	472,00
CVL40010010		NA JEU GARNITURES 400X100 Q.928 +2MM		VI	444,00
CVL40614015		NA JEU DE GARNITURES ADR 406X140 CO 8 TROUS		VI	324,00
DE0100		NA BUTEE DEBRAYAGE HYDRAULIQUE MERCEDES		VI	190,00
DF6392	23,800	DISQUE FREIN ISUZU NPR		VI	108,00
DF6393	12,000	DISQUE FREIN ISUZU		VI	128,00
DF713577	21,000	DISQUE FREIN IVECO ZETA		VI	180,00
DF713685	15,000	DISQUE FREIN DAF		VI	120,00
DF713702	8,831	DISQUE FREIN IVECO DAILY III		VI	64,00
DF713713	15,500	DISQUE FREIN NISSAN ATLEON		VI	190,00
DF713734	9,000	DISQUE FREIN IVECO DAILY III		VI	64,00
DF713745	17,900	DISQUE FREIN IVECO EUROCARGO		VI	240,00
DF713809	6,700	DISQUE FREIN RT B90 1 SERIE		VI	99,00
EB286619		NA RESSORT DE MACHOIRES		VI	7,00
EB286620		NA RESSORT DE RAPPEL		VI	7,00
EB331473		NA BIELETTE FREIN A MAIN		VI	264,00
EB331474		NA BIELETTE FREIN A MAIN		VI	264,00
ECF001	3,235	ECARTEUR DAF IVECO PERROT 360X170 SIMPLEX	360x170 ZE;19503	VI	640,00
ECF001C	3,235	CONSIGNE ECARTEUR		NET	150,00
ECF001ER	3,235	ECARTEUR REMAN DAF IVECO PERROT 360X170 SIMPL.	360x170 ZE;19503	VI	520,00
ECF002	3,780	ECARTEUR IVECO PERROT 410X180 410X200 SIMPLEX	19091;19099	VI	940,00
ECF002C	3,780	CONSIGNE ECARTEUR		NET	150,00
ECF002ER	3,780	ECARTEUR REMAN IVECO PERROT 410X180/200 SIMPL.	19091;19099	VI	700,00
ECF003	4,132	ECARTEUR GRUE PERROT SIMP. 410X180 500X120/160		VI	1 350,00
ECF003C	4,132	CONSIGNE ECARTEUR		NET	150,00
ECF003ER	4,132	ECARTEUR GRUE PERROT SIMP. 410X180 500X120/160		VI	1 000,00
ECF004	4,156	ECARTEUR GRUE PERROT DUPLEX 410X180 500X180		VI	1 100,00
ECF004C	4,156	CONSIGNE ECARTEUR		NET	150,00
ECF004ER	4,156	ECARTEUR REMAN GRUE PERROT DUP. 410X180 500X180		VI	900,00
ECF005	4,132	ECARTEUR GRUE KNOTT SIMPLEX 410X180 500X120/160		VI	980,00
ECF006	4,156	ECARTEUR GRUE KNOTT DUPLEX 410X180 500X180	410X180;500X180 GRUE	VI	880,00
ECF007	0,690	ECARTEUR AUTOMATIQUE IVECO 270X80		VI	180,00
ECF008	0,620	ECARTEUR AUTOMATIQUE IVECO		VI	180,00
ECF009	3,200	ECARTEUR MERITOR 17017	4x4 ME, 360X143;17017	VI	600,00
EE0100		NA EMETTEUR EMBRAYAGE MERCEDES		VI	75,00
EE0132	0,800	EMETTEUR EMBRAYAGE RT		VI	125,00
EE0133	0,760	EMETTEUR EMBRAYAGE RT		VI	125,00
EE0134	0,400	EMETTEUR EMBRAYAGE RENAULT		VI	125,00
EE0135		NA EMETTEUR EMBRAYAGE RENAULT		VI	125,00

REF GIL	Poids	DESIGNATION	OBS	REM	PRIX HT
EE0136	0,920	EMETTEUR EMBRAYAGE RENAULT		VI	125,00
EE0137	0,960	EMETTEUR EMBRAYAGE RENAULT		VI	125,00
EE0138	0,800	EMETTEUR EMBRAYAGE RENAULT		VI	125,00
EE0139	0,340	EMETTEUR EMBRAYAGE RENAULT		VI	194,00
EE0140	0,320	EMETTEUR EMBRAYAGE RENAULT		VI	136,00
EE0141	0,360	EMETTEUR EMBRAYAGE RENAULT		VI	139,00
EE0142	0,320	EMETTEUR EMBRAYAGE RENAULT		VI	141,00
EE0143	0,320	EMETTEUR EMBRAYAGE RENAULT		VI	183,00
EE0144	1,760	EMETTEUR EMBRAYAGE IVECO		VI	100,00
EE0145	1,580	EMETTEUR EMBRAYAGE IVECO		VI	100,00
EE0147	1,720	EMETTEUR EMBRAYAGE IVECO DIA 25,4		VI	100,00
EE0148	1,740	EMETTEUR EMBRAYAGE IVECO EURO CARGO DIA 25,4		VI	100,00
EE0149	0,700	EMETTEUR EMBRAYAGE MERCEDES DIA 20,64		VI	148,00
EE0150	0,780	EMETTEUR EMBRAYAGE MERCEDES DIA 19,05		VI	98,00
EE0152	1,000	EMETTEUR EMBRAYAGE IVECO DIA 19,05		VI	64,00
EE0153	0,760	EMETTEUR EMBRAYAGE MERCEDES DIA 19,05		VI	64,00
EE0154	0,400	EMETTEUR EMBRAYAGE MAN DIA 23,81		VI	190,00
EE0155	0,380	EMETTEUR EMBRAYAGE MAN DIA 23,81		VI	156,00
EE0156	0,800	EMETTEUR EMBRAYAGE MERCEDES DIA 23,81		VI	88,00
EE0157	0,880	EMETTEUR EMBRAYAGE MERCEDES DIA 23,81		VI	78,00
EE0158	0,400	EMETTEUR EMBRAYAGE SCANIA SERIE 4 DIA 25,4		VI	196,00
EE0159	0,860	EMETTEUR EMBRAYAGE SCANIA SERIE 2 DIA 25,4		VI	162,00
EE0160	0,340	EMETTEUR EMBRAYAGE MAN F90-M2000 DIA 25,4		VI	176,00
EE0161	0,800	EMETTEUR EMBRAYAGE VOLVO DIA 28,57		VI	195,00
EE0162	0,800	EMETTEUR EMBRAYAGE VOLVO DIA 28,57		VI	195,00
EE0163	0,520	EMETTEUR EMBRAYAGE SCANIA DIA 25,4		VI	215,00
EE0164	0,340	EMETTEUR EMBRAYAGE DAF DIA 25,4		VI	202,00
EE0165	0,380	EMETTEUR EMBRAYAGE DAF DIA 23,81		VI	202,00
EE0166	0,300	EMETTEUR EMBRAYAGE DAF DIA 22,20		VI	250,00
EE0167	NA	EMETTEUR EMBRAYAGE RT DIA 28,00		VI	132,00
EE0168	0,900	EMETTEUR EMBRAYAGE MERCEDES DIA 26,99		VI	164,00
EE0169	NA	EMETTEUR EMBRAYAGE DAF DIA 28,57		VI	174,00
EE0170	NA	EMETTEUR EMBRAYAGE MAN DIA 25,40		VI	118,00
EE0171	NA	EMETTEUR EMBRAYAGE DAF DIA 25,40		VI	126,00
EE0173	NA	EMETTEUR RECEPTEUR DAILY SYSTEM LUK		VI	120,00
EE0174	NA	EMETTEUR EMBRAYAGE IVECO DIA 31.75		VI	178,00
EE0175	NA	EMETTEUR EMBRAYAGE IVECO DIA 19.05		VI	238,00
EFR001	15,000	ETRIER GAUCHE RT	SEE PAM P 4.67	VI	850,00
EFR001C	NA	CONSIGNE ETRIER		NET	200,00
EFR002	15,000	ETRIER DROIT RT	SEE PAM P 4.67	VI	850,00
EFR002C	NA	CONSIGNE ETRIER		NET	200,00
EFR003	32,500	ETRIER GAUCHE IRISBUS	SEE PAM P 6.67	VI	1 498,00
EFR003C	NA	CONSIGNE ETRIER		NET	300,00
EFR004	32,500	ETRIER DROIT IRISBUS	SEE PAM P 6.67	VI	1 498,00
EFR004C	NA	CONSIGNE ETRIER		NET	300,00
EFR005	5,000	ETRIER GAUCHE RT B90	BENDIX PF 2.52	VI	360,00
EFR005C	NA	CONSIGNE ETRIER		NET	100,00
EFR006	5,000	ETRIER DROIT RT B90	BENDIX PF 2.52	VI	360,00
EFR006C	NA	CONSIGNE ETRIER		NET	100,00
EFR007	4,560	ETRIER GAUCHE RENAULT	BOSCH PF 2.45	VI	196,00
EFR007C	NA	CONSIGNE ETRIER		NET	50,00
EFR008	4,700	ETRIER DROIT RENAULT	BOSCH PF 2.45	VI	196,00
EFR008C	NA	CONSIGNE ETRIER		NET	50,00
EFR009	4,820	ETRIER GAUCHE RENAULT	BOSCH PF 2.45	VI	196,00
EFR009C	NA	CONSIGNE ETRIER		NET	50,00
EFR010	4,740	ETRIER DROIT RENAULT	BOSCH PF 2.45	VI	196,00
EFR010C	NA	CONSIGNE ETRIER		NET	50,00
EFR011	4,800	ETRIER GAUCHE RENAULT	BOSCH PF 2.45	VI	196,00

REF GIL	Poids	DESIGNATION	OBS	REM	PRIX HT
EFR011C		NA CONSIGNE ETRIER		NET	50,00
EFR012	4,540	ETRIER DROIT RENAULT	BOSCH PF 2.45	VI	196,00
EFR012C		NA CONSIGNE ETRIER		NET	50,00
EFR013	2,900	ETRIER GAUCHE RENAULT	BOSCH PFC 1.42	VI	218,00
EFR013C		NA CONSIGNE ETRIER		NET	50,00
EFR014	2,900	ETRIER DROIT RENAULT	BOSCH PFC 1.42	VI	218,00
EFR014C		NA CONSIGNE ETRIER		NET	50,00
EFR015	4,400	ETRIER GAUCHE RENAULT	TRW;LUCAS PF 2.40;45	VI	158,00
EFR015C		NA CONSIGNE ETRIER		NET	50,00
EFR016	4,800	ETRIER DROIT RENAULT	TRW;LUCAS PF 2.40;45	VI	158,00
EFR016C		NA CONSIGNE ETRIER		NET	50,00
EFR017	2,600	ETRIER GAUCHE RENAULT	TRW;LUCAS PFC 1.41	VI	222,00
EFR017C		NA CONSIGNE ETRIER		NET	50,00
EFR018	2,600	ETRIER DROIT RENAULT	TRW;LUCAS PFC 1.41	VI	222,00
EFR018C		NA CONSIGNE ETRIER		NET	50,00
EFR019	15,850	ETRIER GAUCHE VOLVO	MERITOR PF 2.58	VI	420,00
EFR019C		NA CONSIGNE ETRIER		NET	100,00
EFR020	15,800	ETRIER DROIT VOLVO	MERITOR PF 2.58	VI	420,00
EFR020C		NA CONSIGNE ETRIER		NET	100,00
EFR021	19,000	ETRIER GAUCHE VOLVO	MERITOR PF 2.68	VI	435,00
EFR021C		NA CONSIGNE ETRIER		NET	100,00
EFR022	19,000	ETRIER DROIT VOLVO	MERITOR PF 2.68	VI	435,00
EFR022C		NA CONSIGNE ETRIER		NET	100,00
EFR023	13,500	ETRIER GAUCHE MERCEDES	MERITOR PF 2.60	VI	435,00
EFR023C		NA CONSIGNE ETRIER		NET	100,00
EFR024	14,000	ETRIER DROIT MERCEDES	MERITOR PF 2.60	VI	435,00
EFR024C		NA CONSIGNE ETRIER		NET	100,00
EFR025	16,000	ETRIER GAUCHE MERCEDES	MERITOR PF 2.60	VI	435,00
EFR025C		NA CONSIGNE ETRIER		NET	100,00
EFR026	16,000	ETRIER DROIT MERCEDES	MERITOR PF 2.60	VI	435,00
EFR026C		NA CONSIGNE ETRIER		NET	100,00
EFR027	20,000	ETRIER GAUCHE VOLVO	MERITOR PFC 2.58	VI	645,00
EFR027C		NA CONSIGNE ETRIER		NET	100,00
EFR028	20,000	ETRIER DROIT VOLVO	MERITOR PFC 2.58	VI	645,00
EFR028C		NA CONSIGNE ETRIER		NET	100,00
EFR029	18,790	ETRIER GAUCHE VOLVO	MERITOR PFC 2.68	VI	731,00
EFR029C		NA CONSIGNE ETRIER		NET	100,00
EFR030	18,830	ETRIER DROIT VOLVO	MERITOR PFC 2.68	VI	731,00
EFR030C		NA CONSIGNE ETRIER		NET	100,00
EFR031	25,000	ETRIER GAUCHE MERCEDES	MERITOR PFC 2.60	VI	645,00
EFR031C		NA CONSIGNE ETRIER		NET	100,00
EFR032	17,000	ETRIER DROIT MERCEDES	MERITOR PFC 2.60	VI	645,00
EFR032C		NA CONSIGNE ETRIER		NET	100,00
EFR033	17,000	ETRIER GAUCHE MERCEDES	MERITOR PFC 2.60	VI	658,00
EFR033C		NA CONSIGNE ETRIER		NET	100,00
EFR034	25,000	ETRIER DROIT MERCEDES	MERITOR PFC 2.60	VI	658,00
EFR034C		NA CONSIGNE ETRIER		NET	100,00
EFR035	13,500	ETRIER GAUCHE RT	MERITOR PF 2.60	VI	405,00
EFR035C		NA CONSIGNE ETRIER		NET	100,00
EFR036	13,500	ETRIER DROIT RT	MERITOR PF 2.60	VI	405,00
EFR036C		NA CONSIGNE ETRIER		NET	100,00
EFR037	15,300	ETRIER GAUCHE RT	MERITOR PF 2.68	VI	405,00
EFR037C		NA CONSIGNE ETRIER		NET	100,00
EFR038	16,000	ETRIER DROIT RT	MERITOR PF 2.68	VI	405,00
EFR038C		NA CONSIGNE ETRIER		NET	100,00
EFR039	14,520	ETRIER GAUCHE DAF	PERROT P 4.56	VI	768,00
EFR039C		NA CONSIGNE ETRIER		NET	100,00
EFR040	14,539	ETRIER DROIT DAF	PERROT P 4.56	VI	768,00

REF GIL	Poids	DESIGNATION	OBS	REM	PRIX HT
EFR040C		NA CONSIGNE ETRIER		NET	100,00
EFR041	17,000	ETRIER GAUCHE DAF	PERROT P 4.65	VI	850,00
EFR041C		NA CONSIGNE ETRIER		NET	100,00
EFR042	17,000	ETRIER DROIT DAF	PERROT P 4.65	VI	850,00
EFR042C		NA CONSIGNE ETRIER		NET	100,00
EFR043	7,661	ETRIER GAUCHE IVECO	PERROT P 4.44	VI	422,00
EFR043C		NA CONSIGNE ETRIER		NET	100,00
EFR044	7,589	ETRIER DROIT IVECO	PERROT P 4.44	VI	422,00
EFR044C		NA CONSIGNE ETRIER		NET	100,00
EFR045	11,000	ETRIER GAUCHE IVECO	PERROT P 4.50	VI	460,00
EFR045C		NA CONSIGNE ETRIER		NET	100,00
EFR046	10,956	ETRIER DROIT IVECO	PERROT P 4.50	VI	460,00
EFR046C		NA CONSIGNE ETRIER		NET	100,00
EFR047	7,950	ETRIER GAUCHE MERCEDES	PERROT P 4.44	VI	322,00
EFR047C		NA CONSIGNE ETRIER		NET	100,00
EFR048	7,950	ETRIER DROIT MERCEDES	PERROT P 4.44	VI	322,00
EFR048C		NA CONSIGNE ETRIER		NET	100,00
EFR049	7,950	ETRIER GAUCHE MERCEDES	PERROT P 4.44	VI	340,00
EFR049C		NA CONSIGNE ETRIER		NET	100,00
EFR050	7,582	ETRIER DROIT MERCEDES	PERROT P 4.44	VI	340,00
EFR050C		NA CONSIGNE ETRIER		NET	100,00
EFR051	7,682	ETRIER GAUCHE MERCEDES-VW	PERROT PF 2.44	VI	196,00
EFR051C		NA CONSIGNE ETRIER		NET	50,00
EFR052	7,682	ETRIER DROIT MERCEDES-VW	PERROT PF 2.44	VI	196,00
EFR052C		NA CONSIGNE ETRIER		NET	50,00
EFR053	7,950	ETRIER GAUCHE MERCEDES	ATE;TEVES P 4.44	VI	322,00
EFR053C		NA CONSIGNE ETRIER		NET	100,00
EFR054	7,950	ETRIER DROIT MERCEDES	ATE;TEVES P 4.44	VI	322,00
EFR054C		NA CONSIGNE ETRIER		NET	100,00
EFR055	7,950	ETRIER GAUCHE MERCEDES	ATE;TEVES P 4.44	VI	322,00
EFR055C		NA CONSIGNE ETRIER		NET	100,00
EFR056	7,950	ETRIER DROIT MERCEDES	ATE;TEVES P 4.44	VI	322,00
EFR056C		NA CONSIGNE ETRIER		NET	100,00
EFR061		NA ETRIER GAUCHE DAF 400 4X41 2 ENTREES	AP LOCKHEED P 4.41	VI	322,00
EFR061C		NA CONSIGNE ETRIER		NET	200,00
EFR062		NA ETRIER DROIT DAF 400 4X41	AP LOCKHEED P 4.41	VI	330,00
EFR062C		NA CONSIGNE ETRIER		NET	200,00
EFR063	6,100	ETRIER GAUCHE DAF 400 4X46	AP LOCKHEED P 4.46	VI	330,00
EFR063C		NA CONSIGNE ETRIER		NET	200,00
EFR064		NA ETRIER DROIT DAF 400 4X46	AP LOCKHEED P 4.46	VI	330,00
EFR064C		NA CONSIGNE ETRIER		NET	200,00
EFR065	4,900	ETRIER AV GAUCHE MERCEDES VW	BREMBO PF 2.48	VI	226,00
EFR065C		NA CONSIGNE ETRIER		NET	100,00
EFR066	4,840	ETRIER AV DROIT MERCEDES VW	BREMBO PF 2.48	VI	226,00
EFR066C		NA CONSIGNE ETRIER		NET	100,00
EFR067	3,640	ETRIER GAUCHE MERCEDES MB100	BENDIX PF 2.48	VI	226,00
EFR067C		NA CONSIGNE ETRIER		NET	100,00
EFR068	3,640	ETRIER DROIT MERCEDES MB100	BENDIX PF 2.48	VI	226,00
EFR068C		NA CONSIGNE ETRIER		NET	100,00
EFR069	2,940	ETRIER AV GAUCHE MITSUBISHI (SUP) + AXE GUIDAGE	SUPERIEUR	VI	390,00
EFR069C		NA CONSIGNE ETRIER		NET	200,00
EFR070	2,940	ETRIER AV DROIT MITSUBISHI (SUP) + AXE GUIDAGE	SUPERIEUR	VI	390,00
EFR070C		NA CONSIGNE ETRIER		NET	200,00
EFR071	2,980	ETRIER AV GAUCHE MITSUBISHI (INF) + AXE GUIDAGE	INFERIEUR	VI	390,00
EFR071C		NA CONSIGNE ETRIER		NET	200,00
EFR072	2,980	ETRIER AV DROIT MITSUBISHI (INF) + AXE GUIDAGE	INFERIEUR	VI	390,00
EFR072C		NA CONSIGNE ETRIER		NET	200,00
EFR073	4,900	ETRIER AR GAUCHE MERCEDES VW	BOSCH PF 1.51	VI	194,00

REF GIL	Poids	DESIGNATION	OBS	REM	PRIX HT
EFR073C		NA CONSIGNE ETRIER		NET	100,00
EFR074	4,900	ETRIER AR DROIT MERCEDES VW	BOSCH PF 1.51	VI	194,00
EFR074C		NA CONSIGNE ETRIER		NET	100,00
EFR075	4,900	ETRIER AR GAUCHE MERCEDES VW	BOSCH PF 2.48	VI	220,00
EFR075C		NA CONSIGNE ETRIER		NET	100,00
EFR076	4,900	ETRIER AR DROIT MERCEDES VW	BOSCH PF 2.48	VI	220,00
EFR076C		NA CONSIGNE ETRIER		NET	100,00
EFR077	4,900	ETRIER AV GAUCHE MERCEDES VW	BREMBO PF 2.52	VI	220,00
EFR077+	4,900	ETRIER AV GAUCHE MERCEDES VW CARRIER+PLAQ.+TU	BREMBO PF 2.52	VI	286,00
EFR077C		NA CONSIGNE ETRIER		NET	100,00
EFR078	4,900	ETRIER AV DROIT MERCEDES VW	BREMBO PF 2.52	VI	220,00
EFR078+	4,900	ETRIER AV DROIT MERCEDES VW CARRIER+PLAQ.+TU	BREMBO PF 2.52	VI	286,00
EFR078C		NA CONSIGNE ETRIER		NET	100,00
EFR079	4,900	ETRIER FREIN AV GAUCHE NISSAN CABSTAR	BOSCH PF 2.48	VI	244,00
EFR079C		NA CONSIGNE ETRIER		NET	100,00
EFR080	4,900	ETRIER FREIN AV DROIT NISSAN CABSTAR BOSCH 2X48	BOSCH PF 2.48	VI	244,00
EFR080C		NA CONSIGNE ETRIER		NET	100,00
EFR081	4,900	ETRIER FREIN AV GAUCHE NISSAN CABSTAR	BENDIX PF 2.48	VI	330,00
EFR081C		NA CONSIGNE ETRIER		NET	100,00
EFR082	4,900	ETRIER FREIN AV DROIT NISSAN CABSTAR	BENDIX PF 2.48	VI	330,00
EFR082C		NA CONSIGNE ETRIER		NET	100,00
EFR083	4,900	ETRIER FREIN GAUCHE ISUZU	AKEBONO PF 2.54	VI	380,00
EFR083C		NA CONSIGNE ETRIER		NET	150,00
EFR084	4,900	ETRIER FREIN DROIT ISUZU	AKEBONO PF 2.54	VI	380,00
EFR084C		NA CONSIGNE ETRIER		NET	150,00
EFR085		NA ETRIER GAUCHE DROIT MB TRAC 1000	ATE;TEVES P 2.60	VI	406,00
EFR085C		NA CONSIGNE ETRIER		NET	200,00
EFR086		NA ETRIER GAUCHE DROIT MB TRAC 1000	ATE;TEVES P 2.60	VI	406,00
EFR086C		NA CONSIGNE ETRIER		NET	200,00
EFR087	4,900	ETRIER FREIN AV GAUCHE MASTER 2010-	BREMBO PF 2.48	VI	240,00
EFR087C		NA CONSIGNE ETRIER		NET	100,00
EFR088	4,900	ETRIER FREIN AV DROIT MASTER 2010-	BREMBO PF 2.48	VI	240,00
EFR088C		NA CONSIGNE ETRIER		NET	100,00
EFR089	4,900	ETRIER FREIN AR GAUCHE MASTER 2010- ROUE SIMPLE	BREMBO PFC 1.48	VI	250,00
EFR089C		NA CONSIGNE ETRIER		NET	100,00
EFR090	4,900	ETRIER FREIN AR DROIT MASTER 2010- ROUE SIMPLE	BREMBO PFC 1.48	VI	250,00
EFR090C		NA CONSIGNE ETRIER		NET	100,00
EFR091	4,900	ETRIER FREIN AR GAUCHE RT MASTER R. JUMEELEE	BREMBO PFC 1.60	VI	240,00
EFR091C		NA CONSIGNE ETRIER		NET	100,00
EFR092	4,900	ETRIER FREIN AR DROIT MASTER 2010- ROUE JUMEELEE	BREMBO PFC 1.60	VI	240,00
EFR092C		NA CONSIGNE ETRIER		NET	100,00
EFR093		NA ETRIER FREIN GAUCHE MERCEDES UNIMOG DOT4	ATE;TEVES P 2.54	VI	420,00
EFR093C		NA CONSIGNE ETRIER		NET	200,00
EFR094		NA ETRIER FREIN DROIT MERCEDES UNIMOG DOT4	ATE;TEVES P 2.54	VI	420,00
EFR094C		NA CONSIGNE ETRIER		NET	200,00
EFR095		NA ETRIER FREIN GAUCHE MERCEDES SPRINTER 2X45	BOSCH PF 2.45	VI	280,00
EFR095C		NA CONSIGNE ETRIER		NET	100,00
EFR096		NA ETRIER FREIN DROIT MERCEDES SPRINTER 2X45	BOSCH PF 2.45	VI	280,00
EFR096C		NA CONSIGNE ETRIER		NET	100,00
EFR098		NA ETRIER FREIN REMAN PEUGEOT J9 GAUCHE	BENDIX PF 2.48	VI	276,00
EFR098C		NA CONSIGNE ETRIER		NET	100,00
EFR099		NA ETRIER FREIN REMAN PEUGEOT J9 DROIT	BENDIX PF 2.48	VI	276,00
EFR099C		NA CONSIGNE ETRIER		NET	100,00
EFR100	20,000	ETRIER REMAN GAUCHE NISSAN 2X68	MERITOR PFC 2.68	VI	698,00
EFR100C		NA CONSIGNE ETRIER		NET	100,00
EFR101	20,000	ETRIER REMAN DROIT NISSAN 2X68	MERITOR PFC 2.68	VI	698,00
EFR101C		NA CONSIGNE ETRIER		NET	100,00
EFR106		NA ETRIER FREIN GAUCHE MERCEDES UNIMOG DOT4	ATE;TEVES PC 2.54	VI	1 020,00

REF GIL	Poids	DESIGNATION	OBS	REM	PRIX HT
EFR106C		NA CONSIGNE ETRIER		NET	200,00
EFR107		NA ETRIER FREIN DROIT MERCEDES UNIMOG DOT4	ATE;TEVES PC 2.54	VI	1 020,00
EFR107C		NA CONSIGNE ETRIER		NET	200,00
EFR108	20,000	ETRIER FREIN AR GAUCHE MERCEDES 2.54	MERITOR PFC 2.54	VI	674,00
EFR108C		NA CONSIGNE ETRIER		NET	100,00
EFR109	20,000	ETRIER FREIN AR DROIT MERCEDES 2.54	MERITOR PFC 2.54	VI	674,00
EFR109C		NA CONSIGNE ETRIER		NET	100,00
EFR110		NA ETRIER FREIN GAUCHE MERCEDES UNIMOG DOT4	ATE;TEVES P 4.48;57	VI	1 020,00
EFR110C		NA CONSIGNE ETRIER		NET	200,00
EFR111		NA ETRIER FREIN DROIT MERCEDES UNIMOG DOT4	ATE;TEVES P 4.48;57	VI	1 020,00
EFR111C		NA CONSIGNE ETRIER		NET	200,00
EFR112		NA ETRIER FREIN GAUCHE MERCEDES UNIMOG DOT4	ATE;TEVES P 2.60	VI	510,00
EFR112C		NA CONSIGNE ETRIER		NET	200,00
EFR113		NA ETRIER FREIN DROIT MERCEDES UNIMOG DOT4	ATE;TEVES P 2.60	VI	510,00
EFR113C		NA CONSIGNE ETRIER		NET	200,00
EFR114	29,000	ETRIER FREIN GAUCHE MERCEDES UNIMOG DOT4	ATE;TEVES P 4.48;57	VI	2 550,00
EFR114C		NA CONSIGNE ETRIER		NET	300,00
EFR115		NA ETRIER FREIN DROIT MERCEDES UNIMOG DOT4	ATE;TEVES P 4.48;57	VI	2 550,00
EFR115C		NA CONSIGNE ETRIER		NET	300,00
EFR116		NA ETRIER FREIN GAUCHE MERCEDES UNIMOG DOT4	ATE;TEVES PC 2.54	VI	1 224,00
EFR116C		NA CONSIGNE ETRIER		NET	300,00
EFR117		NA ETRIER FREIN DROIT MERCEDES UNIMOG DOT4	ATE;TEVES PC 2.54	VI	1 224,00
EFR117C		NA CONSIGNE ETRIER		NET	300,00
EFR118		NA ETRIER FREIN GAUCHE MULTICAR	KNOTT P 2.46	VI	350,00
EFR118C		NA CONSIGNE ETRIER		NET	300,00
EFR119		NA ETRIER FREIN DROIT MULTICAR	KNOTT P 2.46	VI	350,00
EFR119C		NA CONSIGNE ETRIER		NET	300,00
EFR122		NA ETRIER FREIN AV GAUCHE MERCEDES ATE 2.60	ATE PF 2.60	VI	786,00
EFR122C		NA CONSIGNE ETRIER		NET	100,00
EFR123		NA ETRIER FREIN AV DROIT MERCEDES ATE 2.60	ATE PF 2.60	VI	786,00
EFR123C		NA CONSIGNE ETRIER		NET	100,00
EFR124		NA ETRIER FREIN AV GAUCHE VW LT40-55 ATE 2.57 ABS+	ATE P 2.57	VI	360,00
EFR124C		NA CONSIGNE ETRIER		NET	100,00
EFR125		NA ETRIER FREIN AV DROIT VW LT40-55 ATE 2.57 ABS+	ATE P 2.57	VI	360,00
EFR125C		NA CONSIGNE ETRIER		NET	100,00
EFR126		NA ETRIER FREIN GAUCHE MERCEDES SPRINTER 2X45	BOSCH PF 2.45 V2	VI	280,00
EFR126C		NA CONSIGNE ETRIER		NET	100,00
EFR127		NA ETRIER FREIN DROIT MERCEDES SPRINTER 2X45	BOSCH PF 2.45 V2	VI	280,00
EFR127C		NA CONSIGNE ETRIER		NET	100,00
EFR128	7,682	ETRIER GAUCHE MERCEDES (VOIR EFR051)	PERROT PF 2.44 V2	VI	200,00
EFR128C		NA CONSIGNE ETRIER		NET	50,00
EFR129	7,682	ETRIER DROIT MERCEDES (VOIR EFR052)	PERROT PF 2.44 V2	VI	200,00
EFR129C		NA CONSIGNE ETRIER		NET	50,00
EFR130		NA ETRIER GAUCHE IVECO (1 ENTREE)	AP LOCKHEED P 4.41	VI	344,00
EFR130C		NA CONSIGNE ETRIER		NET	100,00
EFR131		NA ETRIER DROIT IVECO (1 ENTREE)	AP LOCKHEED P 4.41	VI	344,00
EFR131C		NA CONSIGNE ETRIER		NET	100,00
EFR132		NA ETRIER GAUCHE IVECO (2 ENTREES)	AP LOCKHEED P 4.41	VI	344,00
EFR132C		NA CONSIGNE ETRIER		NET	100,00
EFR133		NA ETRIER DROIT IVECO DAILY (2 ENTREES)	AP LOCKHEED P 4.41	VI	344,00
EFR133C		NA CONSIGNE ETRIER		NET	100,00
EFR134	17,160	ETRIER GAUCHE IVECO FORD MERITOR 2.60	MERITOR PFC 2.60	VI	674,00
EFR134C		NA CONSIGNE ETRIER		NET	100,00
EFR135	17,160	ETRIER DROIT IVECO FORD MERITOR 2.60	MERITOR PFC 2.60	VI	674,00
EFR135C		NA CONSIGNE ETRIER		NET	100,00
EFR136		NA ETRIER FREIN AV GAUCHE VW LT40-55 ABS-	ATE P 2.57	VI	360,00
EFR136C		NA CONSIGNE ETRIER		NET	100,00
EFR137		NA ETRIER FREIN AV DROIT VW LT40-55 ABS-	ATE P 2.57	VI	360,00

REF GIL	Poids	DESIGNATION	OBS	REM	PRIX HT
EFR137C		NA CONSIGNE ETRIER		NET	100,00
EFR138		NA ETRIER FREIN AV GAUCHE VW LT40-55 ABS-	ATE P 2.57	VI	360,00
EFR138C		NA CONSIGNE ETRIER		NET	100,00
EFR139		NA ETRIER FREIN AV DROIT VW LT40-55 ABS-	ATE P 2.57	VI	360,00
EFR139C		NA CONSIGNE ETRIER		NET	100,00
EFR140		NA ETRIER FREIN AV GAUCHE RENAULT	GIRLING P 4.48	VI	190,00
EFR140C		NA CONSIGNE ETRIER		NET	30,00
EFR141		NA ETRIER FREIN AV DROIT RT MASTER	GIRLING P 4.48	VI	190,00
EFR141C		NA CONSIGNE ETRIER		NET	30,00
EFR142		NA ETRIER FREIN GAUCHE STILL JUNGHEINRICH	ATE PC 2.42	VI	1 180,00
EFR142C		NA CONSIGNE ETRIER		NET	300,00
EFR143		NA ETRIER FREIN DROIT STILL JUNGHEINRICH	ATE PC 2.42	VI	1 180,00
EFR143C		NA CONSIGNE ETRIER		NET	300,00
EFR144		NA ETRIER REMAN GAUCHE FORD 2X58	MERITOR PF 2.58	VI	694,00
EFR144C		NA CONSIGNE ETRIER		NET	100,00
EFR145		NA ETRIER REMAN DROIT FORD 2X58	MERITOR PF 2.58	VI	694,00
EFR145C		NA CONSIGNE ETRIER	211615107A	NET	100,00
EFR146		NA ETRIER FREIN AV GAUCHE VW TRANSPORTER ATE 2.54	ATE P 2.54	VI	220,00
EFR146C		NA CONSIGNE ETRIER		NET	100,00
EFR147		NA ETRIER FREIN AV DROIT VW TRANSPORTER ATE 2.54	ATE P 2.54	VI	220,00
EFR147C		NA CONSIGNE ETRIER		NET	100,00
EFR148		NA ETRIER FREIN AV GAUCHE J5 C25 GIRLING 38/48	GIRLING PF 2.38/48	VI	200,00
EFR148C		NA CONSIGNE ETRIER		NET	30,00
EFR149		NA ETRIER FREIN AV DROIT J5 C25 GIRLING 38/48	GIRLING PF 2.38/48	VI	200,00
EFR149C		NA CONSIGNE ETRIER		NET	30,00
EFR150		NA ETRIER GAUCHE BREMACH AP LOCKEED 4.38	AP LOCKHEED P 4.38	VI	340,00
EFR150C		NA CONSIGNE ETRIER		NET	100,00
EFR151		NA ETRIER DROIT BREMACH AP LOCKEED 4.38	AP LOCKHEED P 4.38	VI	340,00
EFR151C		NA CONSIGNE ETRIER		NET	100,00
EFR158		NA ETRIER GAUCHE IVECO FORD MERITOR 2.68	MERITOR PFC 2.68	VI	674,00
EFR158C		NA CONSIGNE ETRIER		NET	100,00
EFR159		NA ETRIER DROIT IVECO FORD MERITOR 2.68	MERITOR PFC 2.68	VI	674,00
EFR159C		NA CONSIGNE ETRIER		NET	100,00
EFR160	15,750	ETRIER GAUCHE NISSAN, AWD MERITOR PF 2.68	MERITOR PF 2.68	VI	574,00
EFR160C		NA CONSIGNE ETRIER		NET	100,00
EFR161	15,750	ETRIER DROIT NISSAN, AWD MERITOR PF 2.68	MERITOR PF 2.68	VI	574,00
EFR161C		NA CONSIGNE ETRIER		NET	100,00
EFR162	14,000	ETRIER GAUCHE IVECO FORD MERITOR 2.60	MERITOR PF 2.60	VI	574,00
EFR162C		NA CONSIGNE ETRIER		NET	100,00
EFR163	14,000	ETRIER DROIT IVECO FORD MERITOR 2.60	MERITOR PF 2.60	VI	574,00
EFR163C		NA CONSIGNE ETRIER		NET	100,00
EFR164		NA ETRIER GAUCHE OPEL RENAULT TRAFIC TRW PFC 1.41	TRW PFC 1.41	VI	196,00
EFR164C		NA CONSIGNE ETRIER		NET	50,00
EFR165		NA ETRIER DROIT OPEL RENAULT TRAFIC TRW PFC 1.41	TRW PFC 1.41	VI	196,00
EFR165C		NA CONSIGNE ETRIER		NET	50,00
EFR166	16,500	ETRIER GAUCHE IVECO FORD MERITOR PF 2.68	MERITOR PF 2.68	VI	574,00
EFR166C		NA CONSIGNE ETRIER		NET	100,00
EFR167	16,500	ETRIER GAUCHE IVECO FORD MERITOR PF 2.68	MERITOR PF 2.68	VI	574,00
EFR167C		NA CONSIGNE ETRIER		NET	100,00
EFR168		NA ETRIER GAUCHE VW TRANSPORTER TRW PFC 1.41	TRW PFC 1.41	VI	198,00
EFR168C		NA CONSIGNE ETRIER		NET	50,00
EFR169		NA ETRIER DROIT VW TRANSPORTER TRW PFC 1.41	TRW PFC 1.41	VI	198,00
EFR169C		NA CONSIGNE ETRIER		NET	50,00
EFR170		NA ETRIER GAUCHE MERCEDES VW ATE PF 1.52	ATE PF 1.52	VI	160,00
EFR170C		NA CONSIGNE ETRIER		NET	50,00
EFR171		NA ETRIER DROIT MERCEDES VW ATE PF 1.52	ATE PF 1.52	VI	160,00
EFR171C		NA CONSIGNE ETRIER		NET	50,00
EFR172		NA ETRIER GAUCHE RENAULT TRAFIC BENDIX PF 2.45	BENDIX PF 2.45	VI	120,00

REF GIL	Poids	DESIGNATION	OBS	REM	PRIX HT
EFR172C		NA CONSIGNE ETRIER		NET	50,00
EFR173		NA ETRIER DROIT RENAULT TRAFIC BENDIX PF 2.45	BENDIX PF 2.45	VI	120,00
EFR173C		NA CONSIGNE ETRIER		NET	50,00
EFR174		NA ETRIER GAUCHE MERCEDES VW ATE PF 1.45	ATE PF 1.45	VI	160,00
EFR174C		NA CONSIGNE ETRIER		NET	50,00
EFR175		NA ETRIER DROIT MERCEDES VW ATE PF 1.45	ATE PF 1.45	VI	160,00
EFR175C		NA CONSIGNE ETRIER		NET	50,00
EFR176		NA ETRIER AV GAUCHE MITSUBISHI (SUP) + AXE GUIDAGE	SUMITOMO PF 1.54	VI	390,00
EFR176C		NA CONSIGNE ETRIER		NET	200,00
EFR177		NA ETRIER AV DROIT MITSUBISHI (SUP) + AXE GUIDAGE	SUMITOMO PF 1.54	VI	390,00
EFR177C		NA CONSIGNE ETRIER		NET	200,00
EFR178		NA ETRIER AV GAUCHE MITSUBISHI (INF) + AXE GUIDAGE	SUMITOMO PF 1.54	VI	390,00
EFR178C		NA CONSIGNE ETRIER		NET	200,00
EFR179		NA ETRIER AV DROIT MITSUBISHI (INF) + AXE GUIDAGE	SUMITOMO PF 1.54	VI	390,00
EFR179C		NA CONSIGNE ETRIER		NET	200,00
EFR3358	17,000	ETRIER SIMPLE (CORRESPOND A ZB3358) K85	352063	VI	1 273,00
EFR5000	21,241	ETRIER FREIN GAUCHE RT PAN 17	WABCO PAN 17	VI	720,00
EFR5000C		NA CONSIGNE ETRIER		NET	200,00
EFR5001	20,959	ETRIER FREIN DROIT RT PAN 17	WABCO PAN 17	VI	720,00
EFR5001C		NA CONSIGNE ETRIER		NET	200,00
EFR5002	21,241	ETRIER FREIN GAUCHE DAF PAN 17	WABCO PAN 17	VI	758,00
EFR5002C		NA CONSIGNE ETRIER		NET	200,00
EFR5003	21,241	ETRIER FREIN DROIT DAF PAN 17	WABCO PAN 17	VI	758,00
EFR5003C		NA CONSIGNE ETRIER		NET	200,00
EFR5004	37,500	ETRIER FREIN GAUCHE DAF 1600 V-G	WABCO 1600 V-G	VI	1 660,00
EFR5004C		NA CONSIGNE ETRIER		NET	200,00
EFR5005	37,500	ETRIER FREIN DROIT DAF 1600 V-G	WABCO 1600 V-G	VI	1 660,00
EFR5005C		NA CONSIGNE ETRIER		NET	200,00
EFR5006	21,241	ETRIER FREIN GAUCHE MAN PAN 17	WABCO PAN 17	VI	900,00
EFR5006C		NA CONSIGNE ETRIER		NET	200,00
EFR5007	21,241	ETRIER FREIN DROIT MAN PAN 17	WABCO PAN 17	VI	900,00
EFR5007C		NA CONSIGNE ETRIER		NET	200,00
EFR5008	18,000	ETRIER FREIN GAUCHE MAN 1000 V-G	1000 V-G MAN	VI	758,00
EFR5008C		NA CONSIGNE ETRIER		NET	200,00
EFR5009	18,000	ETRIER FREIN DROIT MAN 1000 V-G	1000 V-G MAN	VI	758,00
EFR5009C		NA CONSIGNE ETRIER		NET	200,00
EFR5300	22,000	ETRIER FREIN GAUCHE MAN MERCEDES SB/SN5	KNORR SB/SN5 POT. CONTINU	VI	750,00
EFR5300C		NA CONSIGNE ETRIER		NET	200,00
EFR5301	22,000	ETRIER FREIN DROIT MAN MERCEDES SB/SN5	KNORR SB/SN5 POT. CONTINU	VI	750,00
EFR5301C		NA CONSIGNE ETRIER		NET	200,00
EFR5302	22,000	ETRIER FREIN GAUCHE MERCEDES SB/SN5	KNORR SB;SN 5 POTENTIO. O/F	VI	614,00
EFR5302C		NA CONSIGNE ETRIER		NET	200,00
EFR5303	22,000	ETRIER FREIN DROIT MERCEDES SB/SN5	KNORR SB;SN 5 POTENTIO. O/F	VI	614,00
EFR5303C		NA CONSIGNE ETRIER		NET	200,00
EFR5304	22,000	ETRIER FREIN GAUCHE MAN SB/SN5	Pot. continu type MAN	VI	614,00
EFR5304C		NA CONSIGNE ETRIER		NET	200,00
EFR5305	22,000	ETRIER FREIN DROIT MAN SB/SN5	Pot. continu type MAN	VI	614,00
EFR5305C		NA CONSIGNE ETRIER		NET	200,00
EFR6002	34,178	ETRIER FREIN GAUCHE PAN 19-2	WABCO PAN 19-2	VI	1 240,00
EFR6002C		NA CONSIGNE ETRIER		NET	200,00
EFR6003	35,714	ETRIER FREIN DROIT PAN 19-2	WABCO PAN 19-2	VI	1 240,00
EFR6003C		NA CONSIGNE ETRIER		NET	200,00
EFR6004	29,479	ETRIER FREIN GAUCHE SAMRO FONTENAX	WABCO PAN 19-1 PLUS	VI	1 020,00
EFR6004C		NA CONSIGNE ETRIER		NET	200,00
EFR6005	28,625	ETRIER FREIN droit SAMRO FONTENAX	WABCO PAN 19-1 PLUS	VI	1 020,00
EFR6005C		NA CONSIGNE ETRIER		NET	200,00
EFR6006	34,980	ETRIER GAUCHE SAF GIGANT (6 T.)	WABCO PAN 19-1 PLUS	VI	798,00
EFR6006C		NA CONSIGNE ETRIER		NET	200,00

REF GIL	Poids	DESIGNATION	OBS	REM	PRIX HT
EFR6007	34,980	ETRIER DROIT SAF GIGANT PAN 19-1 PLUS (6 TROUS)	WABCO PAN 19-1 PLUS	VI	798,00
EFR6007C		NA CONSIGNE ETRIER		NET	200,00
EFR6008		NA ETRIER FREIN GAUCHE PAN 19-1 PLUS MIDLUM 4X4 AV		VI	SD
EFR6008C		NA CONSIGNE ETRIER		NET	SD
EFR6009		NA ETRIER FREIN DROIT PAN 19-1 PLUS MIDLUM 4X4 AV		VI	SD
EFR6009C		NA CONSIGNE ETRIER		NET	SD
EFR6124	33,000	ETRIER FREIN GAUCHE MERCEDES UNIMOG	1300 V-G	VI	1 600,00
EFR6124C		NA CONSIGNE ETRIER		NET	100,00
EFR6125	33,000	ETRIER FREIN DROIT MERCEDES UNIMOG	1300 V-G	VI	1 600,00
EFR6125C		NA CONSIGNE ETRIER		NET	100,00
EFR6200	23,950	ETRIER FREIN GAUCHE/DROIT RT DB19	HALDEX DB19	VI	750,00
EFR6200C		NA CONSIGNE ETRIER		NET	200,00
EFR6201		NA ETRIER FREIN GAUCHE/DROIT GIGANT DB19 6 TROUS	HALDEX DB19	VI	750,00
EFR6201C		NA CONSIGNE ETRIER		NET	200,00
EFR6202		NA ETRIER FREIN REMAN GAUCHE SAF MODULT DBT19LT	HALDEX MODULT DBT19LT	VI	750,00
EFR6202C		NA CONSIGNE ETRIER		NET	200,00
EFR6203		NA ETRIER FREIN REMAN DROIT SAF MODULT DBT19LT	HALDEX MODULT DBT19LT	VI	750,00
EFR6203C		NA CONSIGNE ETRIER		NET	200,00
EFR6300	23,950	ETRIER REMAN SMB GAUCHE 19.5		VI	498,00
EFR6300C		NA CONSIGNE ETRIER		NET	200,00
EFR6301	23,950	ETRIER REMAN SMB DROIT 19.5		VI	498,00
EFR6301C		NA CONSIGNE ETRIER		NET	200,00
EFR6302	23,950	ETRIER REMAN BPW GAUCHE 19.5		VI	614,00
EFR6302C		NA CONSIGNE ETRIER		NET	200,00
EFR6303	23,950	ETRIER REMAN BPW DROIT 19.5		VI	614,00
EFR6303C		NA CONSIGNE ETRIER		NET	200,00
EFR6304	23,950	ETRIER REMAN MERCEDES GAUCHE 19.5		VI	614,00
EFR6304C		NA CONSIGNE ETRIER		NET	200,00
EFR6305	23,950	ETRIER REMAN MERCEDES DROIT 19.5		VI	614,00
EFR6305C		NA CONSIGNE ETRIER		NET	200,00
EFR6306	23,950	ETRIER REMAN MERCEDES GAUCHE 19.5		VI	614,00
EFR6306C		NA CONSIGNE ETRIER		NET	200,00
EFR6307	23,950	ETRIER REMAN MERCEDES DROIT 19.5		VI	614,00
EFR6307C		NA CONSIGNE ETRIER		NET	200,00
EFR6308	32,000	ETRIER REMAN BPW SAF GAUCHE SK7		VI	598,00
EFR6308C		NA CONSIGNE ETRIER		NET	200,00
EFR6309	32,000	ETRIER REMAN BPW SAF DROIT SK7		VI	598,00
EFR6309C		NA CONSIGNE ETRIER		NET	200,00
EFR6310	32,000	ETRIER REMAN IVECO GAUCHE 19.5		VI	656,00
EFR6310C		NA CONSIGNE ETRIER		NET	200,00
EFR6311	32,000	ETRIER REMAN IVECO DROIT 19.5		VI	656,00
EFR6311C		NA CONSIGNE ETRIER		NET	200,00
EFR6312	32,000	ETRIER REMAN IVECO GAUCHE 19.5		VI	656,00
EFR6312C		NA CONSIGNE ETRIER		NET	200,00
EFR6313	32,000	ETRIER REMAN IVECO DROIT 19.5		VI	656,00
EFR6313C		NA CONSIGNE ETRIER		NET	200,00
EFR6314	30,000	ETRIER REMAN MAN GAUCHE 19.5		VI	656,00
EFR6314C		NA CONSIGNE ETRIER		NET	200,00
EFR6315	30,000	ETRIER REMAN MAN DROIT 19.5		VI	656,00
EFR6315C		NA CONSIGNE ETRIER		NET	200,00
EFR6316		NA ETRIER REMAN HENDRICKSON (DROIT) GAUCHE 19.5		VI	656,00
EFR6316C		NA CONSIGNE ETRIER		NET	200,00
EFR6317		NA ETRIER REMAN HENDRICKSON (GAUCHE) DROIT 19.5		VI	656,00
EFR6317C		NA CONSIGNE ETRIER		NET	200,00
EFR6600		NA ETRIER REMAN GAUCHE RVI ELSA VGT 195 AXIAL	RVI;ELSA VGT 195 AXIAL	VI	950,00
EFR6600C		NA CONSIGNE ETRIER		NET	200,00
EFR6601		NA ETRIER REMAN DROIT RVI VGT 195 AXIAL	RVI;ELSA VGT 195 AXIAL	VI	950,00
EFR6601C		NA CONSIGNE ETRIER		NET	200,00

REF GIL	Poids	DESIGNATION	OBS	REM	PRIX HT
EFR6602	NA	ETRIER MEC. ROR LM & LC ELSA 195 LE	ELSA 195	VI	798,00
EFR6602C	NA	CONSIGNE ETRIER		NET	200,00
EFR6603	NA	ETRIER MEC. ROR LM & LC ELSA 195 LE	ELSA 195	VI	798,00
EFR6603C	NA	CONSIGNE ETRIER		NET	200,00
EFR6626	44,500	ETRIER REMAN VOLVO GAUCHE 19.5		VI	1 190,00
EFR6626C	NA	CONSIGNE ETRIER		NET	200,00
EFR6627	44,500	ETRIER REMAN VOLVO DROIT 19.5		VI	1 190,00
EFR6627C	NA	CONSIGNE ETRIER		NET	200,00
EFR6650	35,020	ETRIER REMAN ROR GAUCHE 19.5		VI	530,00
EFR6650C	NA	CONSIGNE ETRIER		NET	200,00
EFR6651	35,020	ETRIER REMAN ROR DROIT 19.5		VI	530,00
EFR6651C	NA	CONSIGNE ETRIER		NET	200,00
EFR6654	34,000	ETRIER REMAN GAUCHE RVI C LISA	C LISA;RPP EFR7654	VI	950,00
EFR6654C	NA	CONSIGNE ETRIER		NET	200,00
EFR6655	35,000	ETRIER REMAN DROIT RVI C LISA	C LISA;RPP EFR7655	VI	950,00
EFR6655C	NA	CONSIGNE ETRIER		NET	200,00
EFR6656	35,000	ETRIER REMAN GAUCHE VOLVO ELSA 195 Axial		NET	1 190,00
EFR6656C	NA	CONSIGNE ETRIER		NET	200,00
EFR6657	NA	ETRIER REMAN DROIT VOLVO ELSA 195 Axial		NET	1 190,00
EFR6657C	NA	CONSIGNE ETRIER		NET	200,00
EFR6900	42,460	ETRIER GAUCHE BENDIX ADB3700 COU COURT	ADB3700	VI	1 300,00
EFR6900C	NA	CONSIGNE ETRIER		NET	300,00
EFR6901	42,460	ETRIER REMAN DROIT BENDIX ADB3700 COU COURT	ADB3700	VI	1 300,00
EFR6901C	NA	CONSIGNE ETRIER		NET	300,00
EFR6902	NA	ETRIER REMAN GAUCHE BENDIX ADB3700 LONG COU	ADB3700	VI	1 250,00
EFR6902C	NA	CONSIGNE ETRIER		NET	300,00
EFR6903	NA	ETRIER REMAN DROIT BENDIX ADB3700 LONG COU	ADB3700	VI	1 250,00
EFR6903C	NA	CONSIGNE ETRIER		NET	300,00
EFR6950	NA	ETRIER REMAN GAUCHE BPW TSB 3709	BPW ECO DISC TSB 3709	VI	720,00
EFR6950C	NA	CONSIGNE ETRIER		NET	200,00
EFR6951	NA	ETRIER REMAN DROIT BPW TSB 3709	BPW ECO DISC TSB 3709	VI	720,00
EFR6951C	NA	CONSIGNE ETRIER		NET	200,00
EFR7000	43,660	ETRIER REMAN GAUCHE SMB PAN22-2	PAN 22-2	VI	1 700,00
EFR7000C	NA	CONSIGNE ETRIER		NET	300,00
EFR7001	NA	ETRIER REMAN DROIT SMB PAN22-2	PAN 22-2	VI	1 700,00
EFR7001C	NA	CONSIGNE ETRIER		NET	300,00
EFR7002	31,689	ETRIER GAUCHE SCHMIDT PAN 22	PAN 22-1	VI	1 000,00
EFR7002C	NA	CONSIGNE ETRIER		NET	200,00
EFR7003	31,247	ETRIER DROIT SCHMIDT PAN 22	PAN 22-1	VI	1 000,00
EFR7003C	NA	CONSIGNE ETRIER		NET	200,00
EFR7004	NA	ETRIER AVANT GAUCHE MAN MAXX 22	MAXX 22	VI	1 200,00
EFR7004C	NA	CONSIGNE ETRIER		NET	200,00
EFR7005	NA	ETRIER AVANT DROIT MAN MAXX 22	MAXX 22	VI	1 200,00
EFR7005C	NA	CONSIGNE ETRIER		NET	200,00
EFR7006	NA	ETRIER MAN TGX TGS AR GAUCHE	MAXX 22	VI	1 200,00
EFR7006C	NA	CONSIGNE ETRIER		NET	200,00
EFR7007	NA	ETRIER MAN TGX TGS AR DROIT	MAXX 22	VI	1 200,00
EFR7007C	NA	CONSIGNE ETRIER		NET	200,00
EFR7200	41,000	ETRIER REMAN GAUCHE DROIT HALDEX MARK 3 (6 T.)	DB22	VI	700,00
EFR7200C	NA	CONSIGNE ETRIER		NET	200,00
EFR7201	41,000	ETRIER REMAN GAUCHE DROIT HALDEX MARK 4 (6 T.)	DB22	VI	700,00
EFR7201C	NA	CONSIGNE ETRIER		NET	200,00
EFR7202	40,000	ETRIER REMAN GAUCHE DROIT SMB MODULX (6 TROUS)	HALDEX DB22	VI	700,00
EFR7202C	NA	CONSIGNE ETRIER		NET	200,00
EFR7203	40,000	ETRIER REMAN GAUCHE DROIT SMB MODULX (4 TROUS)	HALDEX DB22	VI	700,00
EFR7203C	NA	CONSIGNE ETRIER		NET	200,00
EFR7204	30,000	ETRIER REMAN GAUCHE DROIT GIGANT MODULX (6 T.)	HALDEX DB22LT	VI	700,00
EFR7204C	NA	CONSIGNE ETRIER		NET	200,00

REF GIL	Poids	DESIGNATION	OBS	REM	PRIX HT
EFR7206	NA	ETRIER REMAN GAUCHE SAF MODULT (4 TROUS)	HALDEX DBT22LT	VI	750,00
EFR7206C	NA	CONSIGNE ETRIER		NET	200,00
EFR7207	NA	ETRIER REMAN DROIT SAF MODULT (4 TROUS)	HALDEX DBT22LT	VI	750,00
EFR7207C	NA	CONSIGNE ETRIER		NET	200,00
EFR7208	NA	ETRIER REMAN GAUCHE DROIT GIGANT MODULX (6 T.)	HALDEX DB22	VI	750,00
EFR7208C	NA	CONSIGNE ETRIER		NET	200,00
EFR7209	NA	ETRIER REMAN GAUCHE DROIT SAF MODULX (6 TROUS)	HALDEX DB22	VI	750,00
EFR7209C	NA	CONSIGNE ETRIER		NET	200,00
EFR7300	32,250	ETRIER REMAN SMB GAUCHE 22.5		VI	598,00
EFR7300C	NA	CONSIGNE ETRIER		NET	200,00
EFR7301	32,250	ETRIER REMAN SMB DROIT 22.5		VI	598,00
EFR7301C	NA	CONSIGNE ETRIER		NET	200,00
EFR7302	32,250	ETRIER REMAN SAF GAUCHE 22.5		VI	598,00
EFR7302C	NA	CONSIGNE ETRIER		NET	200,00
EFR7303	29,260	ETRIER REMAN SAF DROIT 22.5		VI	598,00
EFR7303C	NA	CONSIGNE ETRIER		NET	200,00
EFR7304	31,640	ETRIER REMAN MERCEDES GAUCHE 22.5		VI	598,00
EFR7304C	NA	CONSIGNE ETRIER		NET	200,00
EFR7305	31,200	ETRIER REMAN MERCEDES DROIT 22.5		VI	598,00
EFR7305C	NA	CONSIGNE ETRIER		NET	200,00
EFR7306	32,250	ETRIER REMAN SCANIA GAUCHE 22.5		VI	656,00
EFR7306C	NA	CONSIGNE ETRIER		NET	200,00
EFR7307	32,250	ETRIER REMAN SCANIA DROIT 22.5		VI	656,00
EFR7307C	NA	CONSIGNE ETRIER		NET	200,00
EFR7308	28,000	ETRIER REMAN DAF GAUCHE 22.5 -2001		VI	614,00
EFR7308C	NA	CONSIGNE ETRIER		NET	200,00
EFR7309	28,000	ETRIER REMAN DAF DROIT 22.5 -2001		VI	614,00
EFR7309C	NA	CONSIGNE ETRIER		NET	200,00
EFR7310	27,780	ETRIER REMAN SCANIA GAUCHE 22.5		VI	598,00
EFR7310C	NA	CONSIGNE ETRIER		NET	200,00
EFR7311	32,250	ETRIER REMAN SCANIA DROIT 22.5		VI	598,00
EFR7311C	NA	CONSIGNE ETRIER		NET	200,00
EFR7312	32,250	ETRIER REMAN EVOBUS GAUCHE 22.5		VI	656,00
EFR7312C	NA	CONSIGNE ETRIER		NET	200,00
EFR7313	32,250	ETRIER REMAN EVOBUS DROIT 22.5		VI	656,00
EFR7313C	NA	CONSIGNE ETRIER		NET	200,00
EFR7314	37,600	ETRIER REMAN EVOBUS GAUCHE 22.5		VI	656,00
EFR7314C	NA	CONSIGNE ETRIER		NET	200,00
EFR7315	37,600	ETRIER REMAN EVOBUS DROIT 22.5		VI	656,00
EFR7315C	NA	CONSIGNE ETRIER		NET	200,00
EFR7316	32,250	ETRIER REMAN EVOBUS GAUCHE 22.5		VI	656,00
EFR7316C	NA	CONSIGNE ETRIER		NET	200,00
EFR7317	32,250	ETRIER REMAN EVOBUS DROIT 22.5		VI	656,00
EFR7317C	NA	CONSIGNE ETRIER		NET	200,00
EFR7318	32,250	ETRIER REMAN SCANIA GAUCHE 22.5		VI	656,00
EFR7318C	NA	CONSIGNE ETRIER		NET	200,00
EFR7319	32,250	ETRIER REMAN SCANIA DROIT 22.5		VI	656,00
EFR7319C	NA	CONSIGNE ETRIER		NET	200,00
EFR7320	32,250	ETRIER REMAN SCANIA GAUCHE 22.5		VI	598,00
EFR7320C	NA	CONSIGNE ETRIER		NET	200,00
EFR7321	32,250	ETRIER REMAN SCANIA DROIT 22.5		VI	598,00
EFR7321C	NA	CONSIGNE ETRIER		NET	200,00
EFR7322	32,250	ETRIER REMAN SCANIA GAUCHE 22.5	K040943;SB7230RC	VI	598,00
EFR7322C	NA	CONSIGNE ETRIER		NET	200,00
EFR7323	32,250	ETRIER REMAN SCANIA DROIT 22.5	K040944;SB7220RC	VI	598,00
EFR7323C	NA	CONSIGNE ETRIER		NET	200,00
EFR7324	32,250	ETRIER REMAN SCANIA GAUCHE 22.5		VI	656,00
EFR7324C	NA	CONSIGNE ETRIER		NET	200,00

REF GIL	Poids	DESIGNATION	OBS	REM	PRIX HT
EFR7325	32,250	ETRIER REMAN SCANIA DROIT 22.5		VI	656,00
EFR7325C		NA CONSIGNE ETRIER		NET	200,00
EFR7326	28,000	ETRIER REMAN GAUCHE MAN 22.5		VI	598,00
EFR7326C		NA CONSIGNE ETRIER		NET	200,00
EFR7327	32,250	ETRIER REMAN DROIT MAN 22.5		VI	598,00
EFR7327C		NA CONSIGNE ETRIER		NET	200,00
EFR7328		NA ETRIER REMAN DAF GAUCHE 22.5 2001-		VI	614,00
EFR7328C		NA CONSIGNE ETRIER		NET	200,00
EFR7329		NA ETRIER REMAN DAF DROIT 22.5 2001-		VI	614,00
EFR7329C		NA CONSIGNE ETRIER		NET	200,00
EFR7330		NA ETRIER REMAN MAN GAUCHE 22.5		VI	614,00
EFR7330C		NA CONSIGNE ETRIER		NET	200,00
EFR7331		NA ETRIER REMAN MAN DROIT 22.5		VI	614,00
EFR7331C		NA CONSIGNE ETRIER		NET	200,00
EFR7332		NA ETRIER REMAN IVECO GAUCHE 22.5		VI	598,00
EFR7332C		NA CONSIGNE ETRIER		NET	200,00
EFR7333		NA ETRIER REMAN IVECO DROIT 22.5		VI	598,00
EFR7333C		NA CONSIGNE ETRIER		NET	200,00
EFR7334	32,250	ETRIER REMAN SCANIA GAUCHE 22.5		VI	656,00
EFR7334C		NA CONSIGNE ETRIER		NET	200,00
EFR7335	32,250	ETRIER REMAN SCANIA DROIT 22.5		VI	656,00
EFR7335C		NA CONSIGNE ETRIER		NET	200,00
EFR7336		NA ETRIER REMAN MAN GAUCHE 22.5		VI	656,00
EFR7336C		NA CONSIGNE ETRIER		NET	200,00
EFR7337		NA ETRIER REMAN MAN DROIT 22.5		VI	656,00
EFR7337C		NA CONSIGNE ETRIER		NET	200,00
EFR7338		NA ETRIER REMAN MERCEDES ACTROS GAUCHE 22.5		VI	1 250,00
EFR7338C		NA CONSIGNE ETRIER		NET	200,00
EFR7339		NA ETRIER REMAN MERCEDES ACTROS DROIT 22.5		VI	1 250,00
EFR7339C		NA CONSIGNE ETRIER		NET	200,00
EFR7340		NA ETRIER REMAN MAN GAUCHE 22.5		VI	656,00
EFR7340C		NA CONSIGNE ETRIER		NET	200,00
EFR7341		NA ETRIER REMAN MAN DROIT 22.5		VI	656,00
EFR7341C		NA CONSIGNE ETRIER		NET	200,00
EFR7342		NA ETRIER REMAN EVOBUS MERCEDES GAUCHE 22.5		VI	656,00
EFR7342C		NA CONSIGNE ETRIER		NET	200,00
EFR7343		NA ETRIER REMAN EVOBUS MERCEDES DROIT 22.5		VI	656,00
EFR7343C		NA CONSIGNE ETRIER		NET	200,00
EFR7344		NA ETRIER REMAN MAN GAUCHE 22.5 KNORR SB/SN7		VI	656,00
EFR7344C		NA CONSIGNE ETRIER		NET	200,00
EFR7345		NA ETRIER REMAN MAN DROIT 22.5 KNORR SB/SN7		VI	656,00
EFR7345C		NA CONSIGNE ETRIER		NET	200,00
EFR7346		NA ETRIER REMAN MERCEDES GAUCHE 22.5 KNORR SL7	KNORR SL7 POT. CONTINU VIS	VI	998,00
EFR7346C		NA CONSIGNE ETRIER		NET	200,00
EFR7347		NA ETRIER REMAN MERCEDES DROIT 22.5 KNORR SL7	KNORR SL7 POT. CONTINU VIS	VI	998,00
EFR7347C		NA CONSIGNE ETRIER		NET	200,00
EFR7348		NA ETRIER REMAN MERCEDES GAUCHE 22.5	KNORR SM7 POT. ON/OFF	VI	998,00
EFR7348C		NA CONSIGNE ETRIER		NET	200,00
EFR7349		NA ETRIER REMAN MERCEDES DROIT 22.5	KNORR SM7 POT. ON/OFF	VI	998,00
EFR7349C		NA CONSIGNE ETRIER		NET	200,00
EFR7350		NA ETRIER REMAN MERCEDES GAUCHE 22.5	KNORR SL7 POT. ON/OFF	VI	998,00
EFR7350C		NA CONSIGNE ETRIER		NET	200,00
EFR7351		NA ETRIER REMAN MERCEDES DROIT 22.5	KNORR SL7 POT. ON/OFF	VI	998,00
EFR7351C		NA CONSIGNE ETRIER		NET	200,00
EFR7352		NA ETRIER REMAN MERCEDES GAUCHE 22.5 KNORR SM7	KNORR SM7 POT. CONTINU VIS	VI	998,00
EFR7352C		NA CONSIGNE ETRIER		NET	200,00
EFR7353		NA ETRIER REMAN MERCEDES DROIT 22.5 KNORR SM7	KNORR SM7 POT. CONTINU VIS	VI	998,00
EFR7353C		NA CONSIGNE ETRIER		NET	200,00

REF GIL	Poids	DESIGNATION	OBS	REM	PRIX HT
EFR7354	NA	ETRIER REMAN SAF SCHMITZ GAUCHE KNORR ST7	KNORR ST7	VI	680,00
EFR7354C	NA	CONSIGNE ETRIER		NET	200,00
EFR7355	NA	ETRIER REMAN SAF SCHMITZ DROIT KNORR ST7	KNORR ST7	VI	680,00
EFR7355C	NA	CONSIGNE ETRIER		NET	200,00
EFR7600	43,000	ETRIER REMAN MAN GAUCHE 22.5	D-3	VI	1 190,00
EFR7600C	NA	CONSIGNE ETRIER		NET	200,00
EFR7601	43,000	ETRIER REMAN MAN DROIT 22.5	D-3	VI	1 190,00
EFR7601C	NA	CONSIGNE ETRIER		NET	200,00
EFR7602	43,000	ETRIER REMAN RENAULT GAUCHE 22.5	D-3	VI	990,00
EFR7602C	NA	CONSIGNE ETRIER		NET	200,00
EFR7603	43,000	ETRIER REMAN RENAULT DROIT 22.5	D-3	VI	990,00
EFR7603C	NA	CONSIGNE ETRIER		NET	200,00
EFR7604	43,000	ETRIER REMAN MERCEDES GAUCHE 22.5	D-3	VI	1 190,00
EFR7604C	NA	CONSIGNE ETRIER		NET	200,00
EFR7605	43,000	ETRIER REMAN MERCEDES DROIT 22.5	D-3	VI	1 190,00
EFR7605C	NA	CONSIGNE ETRIER		NET	200,00
EFR7606	43,000	ETRIER REMAN EVOBUS GAUCHE 22.5	D-3	VI	1 190,00
EFR7606C	NA	CONSIGNE ETRIER		NET	200,00
EFR7607	43,000	ETRIER REMAN EVOBUS DROIT 22.5	D-3	VI	1 190,00
EFR7607C	NA	CONSIGNE ETRIER		NET	200,00
EFR7608	43,000	ETRIER REMAN MERCEDES GAUCHE 22.5	D-3	VI	1 190,00
EFR7608C	NA	CONSIGNE ETRIER		NET	200,00
EFR7609	43,000	ETRIER REMAN MERCEDES DROIT 22.5	D-3	VI	1 190,00
EFR7609C	NA	CONSIGNE ETRIER		NET	200,00
EFR7610	43,000	ETRIER REMAN RENAULT GAUCHE 22.5	D-Lisa	VI	880,00
EFR7610C	NA	CONSIGNE ETRIER		NET	200,00
EFR7611	43,000	ETRIER REMAN RENAULT DROIT 22.5	D-Lisa	VI	880,00
EFR7611C	NA	CONSIGNE ETRIER		NET	200,00
EFR7612	43,000	ETRIER REMAN VOLVO GAUCHE 22.5	D-Lisa	VI	1 190,00
EFR7612C	NA	CONSIGNE ETRIER		NET	200,00
EFR7613	43,000	ETRIER REMAN VOLVO DROIT 22.5	D-Lisa	VI	1 190,00
EFR7613C	NA	CONSIGNE ETRIER		NET	200,00
EFR7614	43,000	ETRIER REMAN DENNIS GAUCHE 22.5	D-Lisa	VI	1 190,00
EFR7614C	NA	CONSIGNE ETRIER		NET	200,00
EFR7615	43,000	ETRIER REMAN DENNIS DROIT 22.5	D-Lisa	VI	1 190,00
EFR7615C	NA	CONSIGNE ETRIER		NET	200,00
EFR7616	44,500	ETRIER REMAN ROR GAUCHE 22.5		VI	1 144,00
EFR7616C	NA	CONSIGNE ETRIER		NET	200,00
EFR7617	44,500	ETRIER REMAN ROR DROIT 22.5		VI	1 144,00
EFR7617C	NA	CONSIGNE ETRIER		NET	200,00
EFR7618	44,500	ETRIER REMAN VOLVO GAUCHE 22.5		VI	1 190,00
EFR7618C	NA	CONSIGNE ETRIER		NET	200,00
EFR7619	44,500	ETRIER REMAN VOLVO DROIT 22.5		VI	1 190,00
EFR7619C	NA	CONSIGNE ETRIER		NET	200,00
EFR7620	44,500	RPP EFR6620		VI	NA
EFR7620C	NA	CONSIGNE ETRIER		NET	NA
EFR7621	44,500	RPP EFR6621		VI	NA
EFR7621C	NA	CONSIGNE ETRIER		NET	NA
EFR7622	44,500	ETRIER REMAN VOLVO GAUCHE 22.5		VI	1 190,00
EFR7622C	NA	CONSIGNE ETRIER		NET	200,00
EFR7623	44,500	ETRIER REMAN VOLVO DROIT 22.5		VI	1 190,00
EFR7623C	NA	CONSIGNE ETRIER		NET	200,00
EFR7624	44,500	ETRIER REMAN VOLVO GAUCHE 22.5		VI	1 190,00
EFR7624C	NA	CONSIGNE ETRIER		NET	200,00
EFR7625	44,500	ETRIER REMAN VOLVO DROIT 22.5		VI	1 190,00
EFR7625C	NA	CONSIGNE ETRIER		NET	200,00
EFR7626	44,500	ETRIER REMAN VOLVO GAUCHE 22.5		VI	1 190,00
EFR7626C	NA	CONSIGNE ETRIER		NET	200,00

REF GIL	Poids	DESIGNATION	OBS	REM	PRIX HT
EFR7627	44,500	ETRIER REMAN VOLVO DROIT 22.5		VI	1 190,00
EFR7627C		NA CONSIGNE ETRIER		NET	200,00
EFR7628	44,500	ETRIER REMAN VOLVO GAUCHE 22.5		VI	1 190,00
EFR7628C		NA CONSIGNE ETRIER		NET	200,00
EFR7629	44,500	ETRIER REMAN VOLVO DROIT 22.5		VI	1 190,00
EFR7629C		NA CONSIGNE ETRIER		NET	200,00
EFR7630	44,500	ETRIER REMAN ROR GAUCHE 22.5		VI	1 190,00
EFR7630C		NA CONSIGNE ETRIER		NET	200,00
EFR7631	44,500	ETRIER REMAN ROR DROIT 22.5		VI	1 190,00
EFR7631C		NA CONSIGNE ETRIER		NET	200,00
EFR7632	44,000	ETRIER REMAN MAN GAUCHE 22.5		VI	1 190,00
EFR7632C		NA CONSIGNE ETRIER		NET	200,00
EFR7633	44,000	ETRIER REMAN MAN DROIT 22.5		VI	1 190,00
EFR7633C		NA CONSIGNE ETRIER		NET	200,00
EFR7634	43,000	ETRIER REMAN MAN GAUCHE 22.5		VI	1 190,00
EFR7634C		NA CONSIGNE ETRIER		NET	200,00
EFR7635	43,000	ETRIER REMAN MAN DROIT 22.5		VI	1 190,00
EFR7635C		NA CONSIGNE ETRIER		NET	200,00
EFR7636	50,000	ETRIER REMAN MAN GAUCHE 22.5		VI	1 190,00
EFR7636C		NA CONSIGNE ETRIER		NET	200,00
EFR7637	50,000	ETRIER REMAN MAN DROIT 22.5		VI	1 190,00
EFR7637C		NA CONSIGNE ETRIER		NET	200,00
EFR7638	50,000	ETRIER REMAN IRISBUS GAUCHE 22.5		VI	980,00
EFR7638C		NA CONSIGNE ETRIER		NET	200,00
EFR7639	50,000	ETRIER REMAN IRISBUS DROIT 22.5		VI	980,00
EFR7639C		NA CONSIGNE ETRIER		NET	200,00
EFR7640	44,000	ETRIER REMAN MAN GAUCHE 22.5		VI	1 190,00
EFR7640C		NA CONSIGNE ETRIER		NET	200,00
EFR7641	44,000	ETRIER REMAN MAN DROIT 22.5		VI	1 190,00
EFR7641C		NA CONSIGNE ETRIER		NET	200,00
EFR7642	44,000	ETRIER REMAN MAN GAUCHE 22.5		VI	1 190,00
EFR7642C		NA CONSIGNE ETRIER		NET	200,00
EFR7643	44,000	ETRIER REMAN MAN DROIT 22.5		VI	1 190,00
EFR7643C		NA CONSIGNE ETRIER		NET	200,00
EFR7644	48,000	ETRIER REMAN MAN GAUCHE 22.5		VI	1 190,00
EFR7644C		NA CONSIGNE ETRIER		NET	200,00
EFR7645	48,000	ETRIER REMAN MAN DROIT 22.5		VI	1 190,00
EFR7645C		NA CONSIGNE ETRIER		NET	200,00
EFR7646	45,000	ETRIER REMAN MAN GAUCHE 22.5		VI	1 190,00
EFR7646C		NA CONSIGNE ETRIER		NET	200,00
EFR7647	45,000	ETRIER REMAN MAN DROIT 22.5		VI	1 190,00
EFR7647C		NA CONSIGNE ETRIER		NET	200,00
EFR7648	44,000	ETRIER REMAN MAN GAUCHE 22.5		VI	1 190,00
EFR7648C		NA CONSIGNE ETRIER		NET	200,00
EFR7649	44,000	ETRIER REMAN MAN DROIT 22.5		VI	1 190,00
EFR7649C		NA CONSIGNE ETRIER		NET	200,00
EFR7650	35,020	RPP EFR6650		VI	598,00
EFR7650C		NA CONSIGNE ETRIER		NET	200,00
EFR7651	35,020	RPP EFR6651		VI	598,00
EFR7651C		NA CONSIGNE ETRIER		NET	200,00
EFR7652	42,000	ETRIER REMAN GAUCHE RVI D2	D2	VI	950,00
EFR7652C		NA CONSIGNE ETRIER		NET	200,00
EFR7653	42,000	ETRIER REMAN DROIT RVI D2	D2	VI	950,00
EFR7653C		NA CONSIGNE ETRIER		NET	200,00
EFR7654	34,000	RPP EFR6654		VI	950,00
EFR7654C		NA CONSIGNE ETRIER		NET	200,00
EFR7655	35,000	RPP EFR6655		VI	950,00
EFR7655C		NA CONSIGNE ETRIER		NET	200,00

REF GIL	Poids	DESIGNATION	OBS	REM	PRIX HT
EFR7656	44,000	ETRIER REMAN GAUCHE RVI BUS D ELSA 1		VI	950,00
EFR7656C		NA CONSIGNE ETRIER		NET	200,00
EFR7657	44,000	ETRIER REMAN DROIT RVI BUS D ELSA 1		VI	950,00
EFR7657C		NA CONSIGNE ETRIER		NET	200,00
EFR7658	47,000	ETRIER REMAN GAUCHE RVI D ELSA 2 PHASE 1		VI	900,00
EFR7658C		NA CONSIGNE ETRIER		NET	200,00
EFR7659	46,500	ETRIER REMAN DROIT RVI D ELSA 2 PHASE 1		VI	900,00
EFR7659C		NA CONSIGNE ETRIER		NET	200,00
EFR7660	42,300	ETRIER REMAN GAUCHE RVI D ELSA 2 PHASE 1		VI	950,00
EFR7660C		NA CONSIGNE ETRIER		NET	200,00
EFR7661	47,000	ETRIER REMAN DROIT RVI D ELSA 2 PHASE 1		VI	950,00
EFR7661C		NA CONSIGNE ETRIER		NET	200,00
EFR7662	45,000	ETRIER REMAN GAUCHE RVI ELSA 2 PHASE 2		VI	900,00
EFR7662C		NA CONSIGNE ETRIER		NET	200,00
EFR7663	47,000	ETRIER REMAN DROIT RVI ELSA 2 PHASE 2		VI	900,00
EFR7663C		NA CONSIGNE ETRIER		NET	200,00
EFR7664	48,000	ETRIER REMAN GAUCHE IRISBUS KAROSA D ELSA 2	IRISBUS	VI	900,00
EFR7664C		NA CONSIGNE ETRIER		NET	200,00
EFR7665	48,000	ETRIER REMAN DROIT IRISBUS KAROSA D ELSA 2	IRISBUS	VI	900,00
EFR7665C		NA CONSIGNE ETRIER		NET	200,00
EFR7666	44,500	ETRIER REMAN GAUCHE IRISBUS ARES RECREO DROIT	ELSA2	VI	950,00
EFR7666C		NA CONSIGNE ETRIER		NET	200,00
EFR7667	43,500	ETRIER REMAN DROIT IRISBUS ARES RECREO GAUCHE	ELSA2	VI	950,00
EFR7667C		NA CONSIGNE ETRIER		NET	200,00
EFR7668	46,000	ETRIER REMAN GAUCHE RENAULT ELSA 2	RVI	VI	900,00
EFR7668C		NA CONSIGNE ETRIER		NET	200,00
EFR7669	46,500	ETRIER REMAN DROIT RENAULT ELSA 2	RVI	VI	900,00
EFR7669C		NA CONSIGNE ETRIER		NET	200,00
EFR7670	46,000	ETRIER REMAN GAUCHE IRISBUS DX225 21	IRISBUS	VI	950,00
EFR7670C		NA CONSIGNE ETRIER		NET	200,00
EFR7671	46,500	ETRIER REMAN DROIT IRISBUS DX225 22	IRISBUS	VI	950,00
EFR7671C		NA CONSIGNE ETRIER		NET	200,00
EFR7672	45,000	ETRIER REMAN GAUCHE IRISBUS AXER ELSA 2	IRISBUS	VI	950,00
EFR7672C		NA CONSIGNE ETRIER		NET	200,00
EFR7673	45,000	ETRIER REMAN DROIT IRISBUS AXER ELSA 2	IRISBUS	VI	950,00
EFR7673C		NA CONSIGNE ETRIER		NET	200,00
EFR7674	45,000	ETRIER REMAN GAUCHE IRISBUS D ELSA 2	IRISBUS	VI	950,00
EFR7674C		NA CONSIGNE ETRIER		NET	200,00
EFR7675	46,500	ETRIER REMAN DROIT IRISBUS D ELSA 2	IRISBUS	VI	950,00
EFR7675C		NA CONSIGNE ETRIER		NET	200,00
EFR7676	46,830	ETRIER REMAN GAUCHE RVI ELSA 225-3 RADIAL	RENAULT TRUCKS ELSA225	VI	950,00
EFR7676C		NA CONSIGNE ETRIER		NET	200,00
EFR7676R	36,000	ETRIER RATIONALISE REMAN GAUCHE RT VOLVO	ELSA 225-3 RADIAL	VI	850,00
EFR7676RC		NA CONSIGNE ETRIER		NET	200,00
EFR7677	46,830	ETRIER REMAN DROIT RVI ELSA 225-3 RADIAL	RENAULT TRUCKS ELSA225	VI	950,00
EFR7677C		NA CONSIGNE ETRIER		NET	200,00
EFR7677R	36,000	ETRIER RATIONALISE REMAN DROIT RVI VOLVO	ELSA 225-3 RADIAL	VI	850,00
EFR7677RC		NA CONSIGNE ETRIER		NET	200,00
EFR7678	43,500	ETRIER REMAN GAUCHE RVI ELSA 225-3 AXIAL	RENAULT TRUCKS ELSA225	VI	900,00
EFR7678C		NA CONSIGNE ETRIER		NET	200,00
EFR7678R	24,000	ETRIER RATIONALISE REMAN GAUCHE RT	ELSA 225-3 AXIAL	VI	850,00
EFR7678RC		NA CONSIGNE ETRIER		NET	200,00
EFR7679	43,500	ETRIER REMAN DROIT RVI ELSA 225-3 AXIAL	RENAULT TRUCKS ELSA225	VI	900,00
EFR7679C		NA CONSIGNE ETRIER		NET	200,00
EFR7679R	24,000	ETRIER RATIONALISE REMAN DROIT RT	ELSA 225-3 AXIAL	VI	850,00
EFR7679RC		NA CONSIGNE ETRIER		NET	200,00
EFR7680	35,000	ETRIER REMAN GAUCHE RVI ELSA 225-1 AXIAL	RENAULT TRUCKS ELSA225	VI	950,00
EFR7680C		NA CONSIGNE ETRIER		NET	200,00

REF GIL	Poids	DESIGNATION	OBS	REM	PRIX HT
EFR7680R	35,000	ETRIER RATIONALISE REMAN GAUCHE RT	ELSA 225-1 AXIAL	VI	850,00
EFR7680RC		NA CONSIGNE ETRIER		NET	200,00
EFR7681	35,000	ETRIER REMAN DROIT RVI ELSA 225-1 AXIAL	RENAULT TRUCKS ELSA225	VI	950,00
EFR7681C		NA CONSIGNE ETRIER		NET	200,00
EFR7681R	35,000	ETRIER RATIONALISE REMAN DROIT RT	ELSA 225-1 AXIAL	VI	850,00
EFR7681RC		NA CONSIGNE ETRIER		NET	200,00
EFR7684	42,000	ETRIER REMAN GAUCHE IRISBUS ZF ELSA 2 PORTAL	IRISBUS	VI	900,00
EFR7684C		NA CONSIGNE ETRIER		NET	200,00
EFR7685	42,000	ETRIER REMAN DROIT IRISBUS ZF ELSA 2 PORTAL	IRISBUS	VI	900,00
EFR7685C		NA CONSIGNE ETRIER		NET	200,00
EFR7686	48,000	ETRIER REMAN GAUCHE IRISBUS ELSA 2 AXIAL	IRISBUS ELSA225	VI	950,00
EFR7686C		NA CONSIGNE ETRIER		NET	200,00
EFR7687	48,000	ETRIER REMAN DROIT IRISBUS ELSA 2 AXIAL	IRISBUS ELSA225	VI	950,00
EFR7687C		NA CONSIGNE ETRIER		NET	200,00
EFR7688R	22,920	ETRIER RATIONALISE GAUCHE VOLVO	ELSA 225-3 AXIAL	VI	850,00
EFR7688RC		NA CONSIGNE ETRIER		NET	200,00
EFR7689R	22,920	ETRIER RATIONALISE DROIT VOLVO ELSA 225-3 AXIAL	VOLVO ELSA225	VI	850,00
EFR7689RC		NA CONSIGNE ETRIER		NET	200,00
EFR7690	24,000	ETRIER REMAN GAUCHE VOLVO ELSA 225-1 AXIAL	VOLVO ELSA225	VI	1 000,00
EFR7690C		NA CONSIGNE ETRIER		NET	200,00
EFR7690R	24,000	ETRIER RATIONALISE GAUCHE VOLVO	ELSA 225-1 AXIAL	VI	850,00
EFR7690RC		NA CONSIGNE ETRIER		NET	200,00
EFR7691	24,000	ETRIER REMAN DROIT VOLVO ELSA 225-1 AXIAL	VOLVO ELSA225	VI	1 000,00
EFR7691C		NA CONSIGNE ETRIER		NET	200,00
EFR7691R	24,000	ETRIER RATIONALISE DROIT VOLVO ELSA 225-1 AXIAL	VOLVO ELSA225	VI	850,00
EFR7691RC		NA CONSIGNE ETRIER		NET	200,00
EFR7692	42,000	ETRIER GAUCHE ROR ELSA 2		VI	900,00
EFR7692C		NA CONSIGNE ETRIER		NET	200,00
EFR7692R	24,000	ETRIER RATIONALISE GAUCHE ROR ELSA 2		VI	798,00
EFR7692RC		NA CONSIGNE ETRIER		NET	200,00
EFR7693	42,000	ETRIER DROIT ROR ELSA 2		VI	900,00
EFR7693C		NA CONSIGNE ETRIER		NET	200,00
EFR7693R	24,000	ETRIER RATIONALISE DROIT ROR ELSA 2		VI	798,00
EFR7693RC		NA CONSIGNE ETRIER		NET	200,00
EFR7694	42,000	ETRIER MEC. MAN D ELSA 2		VI	998,00
EFR7694C		NA CONSIGNE ETRIER		NET	200,00
EFR7695	42,000	ETRIER MEC. MAN D ELSA 2		VI	998,00
EFR7695C		NA CONSIGNE ETRIER		NET	200,00
EFR7696	43,000	ETRIER MEC. ERF /VAN HOOL D ELSA 1		VI	998,00
EFR7696C		NA CONSIGNE ETRIER		NET	200,00
EFR7697	43,000	ETRIER MEC. ERF /VAN HOOL D ELSA 1		VI	998,00
EFR7697C		NA CONSIGNE ETRIER		NET	200,00
EFR7698	45,500	ETRIER MEC. MAN BUS D ELSA 2		VI	998,00
EFR7698C		NA CONSIGNE ETRIER		NET	200,00
EFR7699	45,500	ETRIER MEC. MAN BUS D ELSA 2		VI	998,00
EFR7699C		NA CONSIGNE ETRIER		NET	200,00
EFR7700	45,000	ETRIER MEC. MAN BUS D ELSA 2		VI	998,00
EFR7700C		NA CONSIGNE ETRIER		NET	200,00
EFR7701	45,000	ETRIER MEC. MAN BUS D ELSA 2		VI	998,00
EFR7701C		NA CONSIGNE ETRIER		NET	200,00
EFR7702	44,000	ETRIER MEC. MAN BUS D ELSA 2		VI	998,00
EFR7702C		NA CONSIGNE ETRIER		NET	200,00
EFR7703	44,000	ETRIER MEC. MAN BUS D ELSA 2		VI	998,00
EFR7703C		NA CONSIGNE ETRIER		NET	200,00
EFR7704	35,500	ETRIER MEC. ROR ELSA 225 -2	ROR ELSA225	VI	998,00
EFR7704C		NA CONSIGNE ETRIER		NET	200,00
EFR7705	34,500	ETRIER MEC. ROR ELSA 225 -2	ROR ELSA225	VI	998,00
EFR7705C		NA CONSIGNE ETRIER		NET	200,00

REF GIL	Poids	DESIGNATION	OBS	REM	PRIX HT
EFR7706	41,000	ETRIER MEC. VOLVO ELSA2	ELSA2	VI	998,00
EFR7706C		NA CONSIGNE ETRIER		NET	200,00
EFR7707	41,000	ETRIER MEC. VOLVO ELSA2	ELSA2	VI	998,00
EFR7707C		NA CONSIGNE ETRIER		NET	200,00
EFR7708	47,000	ETRIER REMAN GAUCHE VOLVO ELSA 225-3 RADIAL		VI	998,00
EFR7708C		NA CONSIGNE ETRIER		NET	200,00
EFR7709	47,000	ETRIER REMAN DROIT VOLVO ELSA 225-3 RADIAL		VI	998,00
EFR7709C		NA CONSIGNE ETRIER		NET	200,00
EFR7710		NA ETRIER REMAN GAUCHE BERKHOF MERITOR D2	D2	VI	1 100,00
EFR7710C		NA CONSIGNE ETRIER		NET	200,00
EFR7711		NA ETRIER REMAN DROIT BERKHOF MERITOR D2		VI	1 100,00
EFR7711C		NA CONSIGNE ETRIER		NET	200,00
EFR7712	52,000	ETRIER REMAN BUS GAUCHE MERITOR DX225-17	DX225-17	VI	1 350,00
EFR7712C		NA CONSIGNE ETRIER		NET	200,00
EFR7713	52,000	ETRIER REMAN BUS DROIT MERITOR DX225-18	DX225-18	VI	1 350,00
EFR7713C		NA CONSIGNE ETRIER		NET	200,00
EFR7714	52,000	ETRIER REMAN BUS GAUCHE MERITOR DX225-15	DX225-15	VI	1 350,00
EFR7714C		NA CONSIGNE ETRIER		NET	200,00
EFR7715	52,000	ETRIER REMAN BUS DROIT MERITOR DX225-16	DX225-16	VI	1 350,00
EFR7715C		NA CONSIGNE ETRIER		NET	200,00
EFR7716	45,000	ETRIER REMAN MAN TGA AR GAUCHE	MERITOR D ELSA 2	VI	1 350,00
EFR7716C		NA CONSIGNE ETRIER		NET	200,00
EFR7717	45,000	ETRIER REMAN MAN TGA AR DROIT	MERITOR D ELSA 2	VI	1 350,00
EFR7717C		NA CONSIGNE ETRIER		NET	200,00
EFR7718	47,000	ETRIER REMAN NEOPLAN GAUCHE VAN HOOL DANA	Elsa 2 Phase 2	VI	1 350,00
EFR7718C		NA CONSIGNE ETRIER		NET	200,00
EFR7719	47,000	ETRIER REMAN NEOPLAN DROIT VAN HOOL DANA	Elsa 2 Phase 2	VI	1 350,00
EFR7719C		NA CONSIGNE ETRIER		NET	200,00
EFR7720		NA ETRIER REMAN GAUCHE VAN HOOL ZF Elsa 2 Phase 2		VI	1 350,00
EFR7720C		NA CONSIGNE ETRIER		NET	200,00
EFR7721		NA ETRIER REMAN DROIT VAN HOOL ZF Elsa 2 Phase 2		VI	1 350,00
EFR7721C		NA CONSIGNE ETRIER		NET	200,00
EFR7900		NA ETRIER REMAN GAUCHE IVECO ADB 4300	ADB4300	VI	1 250,00
EFR7900C		NA CONSIGNE ETRIER		NET	300,00
EFR7901		NA ETRIER REMAN DROIT IVECO ADB 4300	ADB4300	VI	1 250,00
EFR7901C		NA CONSIGNE ETRIER		NET	300,00
EFR7950		NA ETRIER REMAN GAUCHE BPW TSB 4309	BPW ECO DISC	VI	720,00
EFR7950C		NA CONSIGNE ETRIER		NET	200,00
EFR7951		NA ETRIER REMAN DROIT BPW TSB 4309	BPW ECO DISC	VI	720,00
EFR7951C		NA CONSIGNE ETRIER		NET	200,00
EFR7952		NA ETRIER REMAN GAUCHE BPW TSB 4312	BPW ECO DISC	VI	850,00
EFR7952C		NA CONSIGNE ETRIER		NET	200,00
EFR7953		NA ETRIER REMAN DROIT BPW TSB 4312	BPW ECO DISC	VI	850,00
EFR7953C		NA CONSIGNE ETRIER		NET	200,00
ER0001		NA ECROU DE ROUE RT M22		VI	8,00
FCD003	24,000	FREIN DUPLEX 381X178 GAUCHE		VI	1 690,00
FCD004		NA FREIN DUPLEX 381X178 DROIT		VI	1 690,00
FCD005		NA FREIN DUPLEX 410X180 GAUCHE		VI	943,00
FCD006		NA FREIN DUPLEX 410X180 DROIT		VI	943,00
FCD009		NA FREIN DUPLEX 410X200		VI	1 241,00
FCD010		NA FREIN DUPLEX 410X200		VI	1 241,00
FCD011	31,500	FREIN DUPLEX 410X200 GAUCHE		VI	1 044,00
FCD012	31,500	FREIN DUPLEX 410X200 DROIT		VI	1 044,00
FCS001		NA FREIN SIMPLEX 381 GAUCHE		VI	1 019,00
FCS002		NA FREIN SIMPLEX 381 DROIT		VI	1 019,00
FCS003		NA FREIN SIMPLEX 360 X 170 GAUCHE	IRISBUS MIDWAY	VI	1 766,00
FCS004		NA FREIN SIMPLEX 360 X 170 DROIT	IRISBUS MIDWAY	VI	1 766,00
FCS005		NA FREIN SIMPLEX 410X180 GAUCHE		VI	1 257,00

REF GIL	Poids	DESIGNATION	OBS	REM	PRIX HT
FCS006		NA FREIN SIMPLEX 410X180 DROIT		VI	1 257,00
FCS009		NA FREIN SIMPLEX 410X200 GAUCHE		VI	1 594,00
FCS010		NA FREIN SIMPLEX 410X200 DROIT		VI	1 594,00
FCS011	30,500	FREIN SIMPLEX 410X200 GAUCHE		VI	1 760,00
FCS012	30,500	FREIN SIMPLEX 410X200 DROIT		VI	1 760,00
FCS100		NA FREIN SIMPLEX 381 RT	381x178	VI	1 144,00
FL3001	6,000	FLASQ. GAUCHE IVECO DAILY	254x90	VI	162,00
FL3002	6,000	FLASQ. DROITE IVECO DAILY	254x90	VI	162,00
GAR310X80		NA JEU GARNITURES RT SG3 310X150		VI	236,00
GAR363X125X12.3		NA GARNITURES FREIN 406X125 19T Q928 CO		VI	258,00
GR0001		NA GOUJON DE ROUE		VI	25,00
HBK2001	28,000	KIT COMPLET PARKING MASCOTT		VI	598,00
HBK2001+	29,000	KIT PARKING COMPLET MASCOTT +PLAQUETTES+TU		VI	630,00
HBK2002	29,000	KIT PARKING COMPLET DAILY		VI	498,00
HBK2002+	30,000	KIT PARKING COMPLET DAILY+PLAQ.+TU		VI	539,00
KA0001		NA KIT VIS ECROU RT		VI	94,00
KA0002	0,380	KIT ECROU IVECO		VI	64,00
KA0003		NA KIT D'ACCESSOIRES Z-CAME	19068;19071;19090	VI	184,00
KB0001	0,200	KIT BAGUES RT		VI	66,00
KDC1000	34,600	KIT COMPLET DISQUES IVECO DAILY SERIE C AV		VI	720,00
KDC1000C	0,000	CONSIGNES ETRIERES 522970010C & 522970020C		NET	40,00
KDC1001	34,800	KIT COMPLET DISQUES IVECO DAILY SERIE L & S AV		VI	720,00
KDC1001C	0,000	CONSIGNES ETRIERES 522970010C & 522970020C		NET	40,00
KDC1002	33,120	KIT COMPLET DISQUES NISSAN RT AV		VI	720,00
KDC1002C	0,000	CONSIGNES ETRIERES 522970076C & 522970086C		NET	40,00
KDC1003	33,120	KIT COMPLET DISQUES NISSAN OPEL RT MASTER III		VI	720,00
KDC1003C	0,000	CONSIGNES ETRIERES EFR087C & EFR088C		NET	200,00
KDC3000		NA KIT COMPLET DISQUES IVECO DAILY SERIE C ABS- AR		VI	998,00
KDC3000C		NA CONSIGNES ETRIERES 522972100C & 522972101C		NET	60,00
KDC3001		NA KIT COMPLET DISQUES IVECO DAILY SERIE C ABS+ AR		VI	998,00
KDC3001C		NA CONSIGNES ETRIERES 522972100C & 522972101C		NET	60,00
KDC3002		NA KIT COMPLET DISQUES NISSAN RT MAXITY ABS+ AR		VI	860,00
KDC3002C		NA CONSIGNES ETRIERES 522971575C & 522971585C		NET	60,00
KDC3003		NA KIT COMPLET DISQUES NISSAN RT MAXITY ABS- AR		VI	860,00
KDC3003C		NA CONSIGNES ETRIERES 522971575C & 522971585C		NET	60,00
KDC3004		NA KIT COMPLET DISQUES NISSAN OPEL RT MASTER III		VI	620,00
KDC3004C		NA CONSIGNES ETRIERES EFR089C & EFR090C		NET	200,00
KDC3005		NA KIT COMPLET DISQUES NISSAN OPEL RT MASTER III		VI	620,00
KDC3005C		NA CONSIGNES ETRIERES EFR089C & EFR090C		NET	200,00
KDC3006		NA KIT COMPLET DISQUES NISSAN OPEL RT MASTER III		VI	620,00
KDC3006C		NA CONSIGNES ETRIERES EFR091C & EFR092C		NET	200,00
KF6001	7,700	KIT FREIN RT	305x80	VI	536,00
KF6002	6,170	KIT FREIN RT	305x70	VI	638,00
KF6100	6,000	KIT FREIN NISSAN 280X65	280X65	VI	340,00
KF6101	3,600	KIT FREIN NISSAN 254X57	254X57	VI	263,00
KF6200		NA KIT FREIN DB		VI	472,00
KF6201		NA KIT FREIN DB		VI	509,00
KF6202	6,500	KIT FREIN DB		VI	578,00
KF6203		NA KIT FREIN IVECO		VI	622,00
KF6204		NA KIT FREIN IVECO		VI	1 411,00
KF6205		NA KIT FREIN DAF		VI	1 882,00
KF6206		NA KIT FREIN DAF		VI	2 231,00
KF6207		NA KIT FREIN PREMONTE IVECO 254X70 DIA 15,9		VI	320,00
KGA001	0,520	KIT GALET+AXE+2 CIRCLIPS		VI	6,00
KNT5001021		NA ECARTEUR AUTOMATIQUE 325X80		VI	610,00
KRES005		NA KIT RESSORT DE MACHOIRES RT	17352;19709	VI	64,00
KRES006		NA KIT RESSORT DE MACHOIRES RT	19255;19259	VI	54,00
KRES007	0,860	KIT RESSORT DE MACHOIRES IVECO PERROT	19503	VI	60,00

REF GIL	Poids	DESIGNATION	OBS	REM	PRIX HT
KRES008	0,950	KIT RESSORT DE MACHOIRES IVECO PERROT	19091;19099	VI	86,00
KRES009	0,790	KIT RESSORT IVECO STOPMASTER DUPLEX	19109;19116	VI	28,00
KRES010	0,560	KIT RESSORT DE MACHOIRES IVECO ROC. SIMPLEX	19553;19555;19714;19716	VI	20,00
KRES011	NA	KIT RESSORT IVECO 270X80 (POUR 1 FREIN)	15030	VI	50,00
KRG001	0,730	KIT REPARATION GALETS MAN MERCEDES	19495;19496;	VI	12,60
KTU001	0,060	KIT TEMOINS D'USURE RT 29173/174/177/169	29173;29174;29177;29169	VI	42,00
KTU002	0,090	KIT TEMOINS D'USURE RT 29131	29131	VI	35,00
KTU003	0,040	KIT TEMOINS D'USURE RT 29030/090/100/131	29030;29090;29100;29131	VI	35,00
KTU004	0,140	KIT TEMOINS D'USURE RT 29142	29142	VI	57,00
KTU005	0,100	KIT TEMOINS D'USURE RT 29030/090/100/142	29030;29090;29100;29142	VI	57,00
KTU006	NA	KIT TEMOINS D'USURE RT 29030/088	29030;29088	VI	42,00
KTU007	0,110	KIT TEMOINS D'USURE RT 29088	29088	VI	51,00
KTU008	0,110	KIT TEMOINS D'USURE MERCEDES 29835	29835	VI	17,00
KTU009	0,110	KIT TEMOINS D'USURE IVECO 29087	29087	VI	82,00
KTU010	0,060	KIT TEMOINS D'USURE IVECO PERROT 19503	19503	VI	70,00
KTU011	0,040	KIT TEMOINS USURE IVECO ROC. DUPLEX 410X180/200	19109;19110;19116;19119;	VI	80,00
LPP150	NA	POT A RESSORT REMAN		VI	1 058,00
LW17201	NA	CYLINDRE ROUE REMAN DROIT AP DIA 44.5 1 PISTON		VI	599,00
LW17202	NA	CYLINDRE ROUE REMAN GAUCHE AP DIA 44.5 1 PISTON		VI	599,00
LW17203	NA	CYLINDRE ROUE REMAN DROIT AP DIA 44.5 2 PISTONS		VI	790,00
LW17204	NA	CYLINDRE ROUE REMAN GAUCHE DIA. 44.5 2 PISTONS		VI	790,00
MAC7017	NA	MACHOIRE NUE MAN RT 360X140	17017	VI	198,00
MAC7374P	NA	MACHOIRE NUE GRUE 500X120	17374	VI	278,00
MAC7992/2	13,000	KIT 2 MACHOIRES NUES 410X125	17992	VI	129,00
MAC9041P	NA	MACHOIRE NUE GRUE 500X180	19041	VI	268,00
MAC9042P	NA	MACHOIRE NUE GRUE 500X160	19042	VI	286,00
MAC9063/64	NA	MACHOIRE NUE DAF 420X200	19063;19064	VI	160,00
MAC9068/2	13,000	KIT 2 MACHOIRES NUES 410X225	19068	VI	100,00
MAC9071/2	14,000	KIT 2 MACHOIRES NUES 410X200	19071	VI	100,00
MAC9090/2	12,500	KIT 2 MACHOIRES NUES 410X175	19090	VI	100,00
MAC9091/98	NA	MACHOIRE NUE PERROT 410X202	19091;19098	VI	150,00
MAC9113P	NA	MACHOIRE NUE GRUE 410X180	19113	VI	SD
MAC9187	12,000	MACHOIRE NUE RT 414X220 AVEC GALET	19187	VI	164,00
MAC9187K	12,000	MACHOIRE NUE RT 414X220 KERAX AVEC GALET	19187	VI	164,00
MAC9384D	NA	MACHOIRE NUE IVECO 381X178	19384	VI	90,00
MAC9495CAST	NA	MACHOIRE NUE MAN MERCEDES 410X183 AVEC GALET	19495	VI	160,00
MAC9496CAST	NA	MACHOIRE NUE MAN MERCEDES 410X223 AVEC GALET	19496	VI	160,00
MAC9503	NA	MACHOIRE NUE IVECO 360X170	19503	VI	120,00
MAC9932	10,000	MACHOIRE NUE SCANIA 413X203	19932	VI	160,00
MAC9933	11,000	MACHOIRE NUE SCANIA 413X254	19933	VI	306,00
MAC9934	11,000	MACHOIRE NUE RT 414X150 AVEC GALET	19934	VI	160,00
MAC9934K	11,000	MACHOIRE NUE RT 414X150 REDUIT AVEC GALET	19934	VI	160,00
MAC9935	12,000	MACHOIRE NUE RT 414X175 AVEC GALET	19935	VI	164,00
MAC9935K	12,000	MACHOIRE NUE RT 414X175 KERAX AVEC GALET	19935	VI	164,00
MAC9941/2	13,000	KIT 2 MACHOIRES NUES 410X150	19941	VI	139,00
MAC9974	12,500	MACHOIRE NUE IRISBUS 414X200	19974	VI	213,00
MAG0001	7,430	MACHOIRE GARNIE		VI	309,00
MAG0002	7,500	MACHOIRE GARNIE		VI	309,00
MAG0003	0,010	MACHOIRE GARNIE		VI	309,00
MAK0001	23,000	KIT MACHOIRES 381X178 STD0		VI	510,00
MAK0002	10,000	KIT MACHOIRES 381X178 +1		VI	589,00
MAK0003	23,000	KIT MACHOIRES 381X178 +2		VI	674,00
MAK0004	23,000	KIT MACHOIRES 381X178 STD0		VI	743,00
MAK0005	23,000	KIT MACHOIRES 381X178 +1		VI	764,00
MAK0006	20,000	KIT MACHOIRES 381X178 +2		VI	776,00
MC0040	4,000	MAITRE CYLINDRE L611040		VI	340,00
MC0079	4,000	MAITRE CYLINDRE L611079		VI	704,00
MC0092	1,460	MAITRE CYLINDRE IVECO		VI	194,00

REF GIL	Poids	DESIGNATION	OBS	REM	PRIX HT
MC0093	1,200	MAITRE CYLINDRE MERCEDES		VI	134,00
MC0100	1,860	MAITRE CYLINDRE IVECO		VI	124,00
MC0101	1,800	MAITRE CYLINDRE IVECO		VI	154,00
MC0110	1,740	MAITRE CYLINDRE IVECO	BRIDE 4 TROUS	VI	154,00
MC0161	1,580	MAITRE CYLINDRE IVECO		VI	154,00
MC0187	0,900	MAITRE CYLINDRE RT	L611187	VI	124,00
MC0188	1,720	MAITRE CYLINDRE RT DIA 38,1	L611188	VI	570,00
MC0189	0,500	MAITRE CYLINDRE	L611189	VI	336,00
MC0235	1,500	MAITRE CYLINDRE RT		VI	204,00
MC0277	0,350	MAITRE CYLINDRE	L611277	VI	796,00
MC0281	0,880	MAITRE CYLINDRE	L611281	VI	188,00
MC0292	0,650	MAITRE CYLINDRE IVECO		VI	254,00
MC0308	1,440	MAITRE CYLINDRE DB		VI	238,00
MC0359	0,780	MAITRE CYLINDRE	L611359;L611360	VI	324,00
MC0381	1,960	MAITRE CYLINDRE TANDEM RT	L613381	VI	754,00
MC0391	2,800	MAITRE CYLINDRE TANDEM RT	L613391	VI	854,00
MC0415	0,500	MAITRE CYLINDRE TANDEM RENAULT NISSAN OPEL		VI	164,00
MC0431	2,000	MAITRE CYLINDRE IVECO		VI	164,00
MC0460	1,720	MAITRE CYLINDRE IVECO RT		VI	164,00
MC0468	1,460	MAITRE CYLINDRE IVECO		VI	154,00
MC0473	1,400	MAITRE CYLINDRE DB		VI	248,00
MC0483	1,800	MAITRE CYLINDRE SIMPLE 111483B DIA 25.4		VI	64,00
MC0585	1,800	MAITRE CYLINDRE TANDEM RT	L613585	VI	198,00
MC0616	0,980	MAITRE CYLINDRE DB		VI	248,00
MC0617	1,000	MAITRE CYLINDRE DB		VI	248,00
MC0618	1,300	MAITRE CYLINDRE DB		VI	182,00
MC0619	1,380	MAITRE CYLINDRE VW		VI	242,00
MC0620	1,320	MAITRE CYLINDRE DB		VI	224,00
MC0621	1,560	MAITRE CYLINDRE DAF		VI	400,00
MC0622	1,580	MAITRE CYLINDRE DAF		VI	202,00
MC0623	2,320	MAITRE CYLINDRE IVECO DIA 25,40		VI	210,00
MC0624	2,320	MAITRE CYLINDRE IVECO DIA 28,57		VI	128,00
MC0625	1,480	MAITRE CYLINDRE IVECO DIA 25,40		VI	210,00
MC0626	2,420	MAITRE CYLINDRE IVECO IRISBUS RT R312 DIA 44,45	BRIDE 4 TROUS	VI	220,00
MC0627	3,000	MAITRE CYLINDRE IVECO DIA 38,10		VI	294,00
MC0628	3,000	MAITRE CYLINDRE IVECO DIA 26,99		VI	140,00
MC0629	3,000	MAITRE CYLINDRE IVECO DIA 25,40		VI	246,00
MC0630		NA MAITRE CYLINDRE MERCEDES DIA 34.92		VI	370,00
MC0631		NA MAITRE CYLINDRE TANDEM PEUGEOT P4 23.81 BOCAL+		VI	324,00
MC0632		NA MAITRE CYLINDRE IVECO DIA 31.75		VI	266,00
MC0633		NA MAITRE CYLINDRE IVECO DIA 31.75		VI	412,00
MC0634		NA MAITRE CY. IVECO DIA 31.75 ALU FILET. 10X1 (2)		VI	504,00
MC0635		NA MAITRE CYLINDRE IVECO DIA 25.40 ALUMINIUM		VI	504,00
MC0636		NA MAITRE CYL. IVECO ALU FILET.E 12X1 (2)		VI	504,00
MC0637		NA MAITRE CYLINDRE NISSAN RT DIA 26,99		VI	SD
MF0353	3,120	MACHOIRES FREIN NISS 254X57		VI	130,00
MF0407		NA MACHOIRES FREIN DAF 400		VI	110,00
MF0503	3,120	MACHOIRES FREIN DAF 400 IVECO DAILY 254X70		VI	209,00
MF0525	3,340	MACHOIRES FREIN DB		VI	300,00
MF0564		NA MACHOIRES FREIN NISS		VI	219,00
MF0572	2,140	MACHOIRES FREIN DB		VI	328,00
MF0600		NA MACHOIRES FREIN RT		VI	SD
MF0601		NA MACHOIRES FREIN RT		VI	380,00
MF0602		NA MACHOIRES FREIN RT		VI	391,00
MF0603		NA MACHOIRES FREIN RT		VI	SD
MF0604		NA MACHOIRES FREIN RT		VI	480,00
MF0605		NA MACHOIRES FREIN RT		VI	SD
MF0606		NA MACHOIRES FREIN RT		VI	SD

REF GIL	Poids	DESIGNATION	OBS	REM	PRIX HT
MF0607		NA MACHOIRES FREIN RT		VI	SD
MF0608		NA MACHOIRES FREIN RT		VI	SD
MF0609		NA MACHOIRES FREIN RT		VI	SD
MF0611		NA MACHOIRES FREIN RT		VI	SD
MF0612		NA MACHOIRES FREIN RT		VI	SD
MP0558	1,600	MACHOIRES PARK IVECO		VI	88,00
MP0558+	2,800	MACHOIRES PARK IVECO		VI	136,00
MP0558++	3,200	MACHOIRES PARK RENA		VI	180,00
MP0574	1,600	MACHOIRES PARK DB & VW 160X40 +ACC		VI	78,00
MP0594	1,600	MACHOIRES PARK DB & VW		VI	78,00
MP0650SA	1,800	MACHOIRES PARK IVECO - ACC.		VI	132,00
MP0651	1,750	MACHOIRES PARK IVECO		VI	104,00
MP0651+	2,800	MACHOIRES PARK IVECO		VI	152,00
MP0651++	3,200	MACHOIRES PARK RENA		VI	196,00
MP0655	1,200	MACHOIRES PARK DB & VW		VI	122,00
MP0678SA	1,200	MACHOIRES PARK DB & VW		VI	122,00
MR0001		NA MOYEU DE ROUE RT		VI	953,00
PF1016	2,260	PLAQUETTES FREIN NISS	23435, 23434	VI	84,00
PF1235	3,480	PLAQUETTES FREIN ISUZU NPR	25800	VI	102,00
PF1236	3,480	PLAQUETTES FREIN ISUZU NPR NQR 7,5	29258	VI	102,00
PF1580	3,480	PLAQUETTES FREIN ISUZU NPR AR	AKEBONO	VI	102,00
PK08.5952.10	23,440	KIT FREIN PARK IVECO		VI	298,00
PK08.7724.10	14,680	KIT FREIN PARK DB		VI	218,00
PK08.7724.20	14,480	KIT FREIN PARK DB		VI	202,00
PK08.7725.10	16,080	KIT FREIN PARK DB		VI	217,00
PK08.7725.20	16,080	KIT FREIN PARK DB		VI	176,00
PK09.7263.20	22,950	KIT FREIN PARK RT		VI	319,00
PK09.8475.10	16,770	KIT FREIN PARK DB		VI	217,00
PMN129		NA MAITRE-CYLINDRE NISSAN ATLEON		VI	390,00
PSP001		NA PLAQUETTES FREIN SPECIALES (4)		VI	45,00
PSP002		NA PLAQUETTE DE FREIN SPECIALE (1)		VI	14,00
PSP003		NA PLAQUETTE DE FREIN SPECIALE (1)		VI	14,00
PSP004		NA PLAQUETTES FREIN SPECIALES		VI	SD
PSP005		NA PLAQUETTE DE FREIN SPECIALE (1)		VI	22,00
PSP006		NA PLAQUETTES FREIN SPECIALES (4)		VI	23,00
PSP007		NA PLAQUETTES FREIN SPECIALES		VI	SD
PSP008		NA PLAQUETTES FREIN SPECIALES (8)		VI	169,00
PSP009	0,440	PLAQUETTE DE FREIN SPECIALE (1)		VI	20,00
PSP010		NA PLAQUETTES FREIN SPECIALES		VI	SD
PSP011		NA PLAQUETTES FREIN SPECIALES		VI	SD
PSP012	0,400	PLAQUETTES FREIN SPECIALES (4)		VI	211,00
PSP101		NA PLAQUETTE DE FREIN SPECIALE (1)		VI	89,00
PSP102		NA PLAQUETTE DE FREIN SPECIALE (1)		VI	71,00
PSP103		NA PLAQUETTE DE FREIN SPECIALE (1)		VI	71,00
PSP104		NA PLAQUETTES FREIN SPECIALES (8)		VI	423,00
PSP105		NA PLAQUETTES FREIN SPECIALES		VI	SD
PSP106		NA PLAQUETTES FREIN SPECIALES		VI	SD
PSP107		NA PLAQUETTES FREIN SPECIALES		VI	SD
PSP108		NA PLAQUETTES FREIN SPECIALES		VI	SD
PSP109	2,720	PLAQUETTES FREIN SPECIALES (4)		VI	114,00
PSP110		NA PLAQUETTES FREIN SPECIALES (2+2)		VI	266,00
PSP111		NA PLAQUETTES FREIN SPECIALES (2+2)		VI	266,00
PSP112		NA PLAQUETTES FREIN SPECIALES (6+2)		VI	478,00
PSP113		NA PLAQUETTES FREIN SPECIALES (4)		VI	128,00
PSP114		NA PLAQUETTES FREIN SPECIALES		VI	SD
PSP115		NA PLAQUETTE DE FREIN SPECIALE (1)		VI	94,00
PSP116		NA PLAQUETTES FREIN SPECIALES (4)		VI	136,00
PSP117		NA PLAQUETTES FREIN SPECIALES		VI	SD

REF GIL	Poids	DESIGNATION	OBS	REM	PRIX HT
PSP118	8,240	PLAQUETTE DE FREIN SPECIALE (1)		VI	74,00
PSP119	NA	PLAQUETTE DE FREIN SPECIALE (1)		VI	128,00
PSP120	NA	PLAQUETTES FREIN SPECIALES (8)		VI	468,00
PSP121	NA	PLAQUETTES FREIN SPECIALES		VI	SD
PSP122	NA	PLAQUETTES FREIN SPECIALES		VI	SD
PSP123	NA	PLAQUETTE DE FREIN SPECIALE (1)		VI	43,00
PSP124	NA	PLAQUETTE DE FREIN SPECIALE (1)		VI	85,00
PSP125	NA	PLAQUETTE DE FREIN SPECIALE (1)		VI	158,00
PSP126	NA	PLAQUETTES FREIN SPECIALES		VI	SD
PSP127	NA	PLAQUETTES FREIN SPECIALES		VI	SD
PSP128	NA	PLAQUETTES FREIN SPECIALES (8)		VI	423,00
PSP129	NA	PLAQUETTES FREIN SPECIALES (6+2)		VI	446,00
PSP130	NA	PLAQUETTES FREIN SPECIALES (6+2)		VI	529,00
PSP131	NA	PLAQUETTES FREIN SPECIALES		VI	35,00
PSP132	NA	PLAQUETTES FREIN SPECIALES (8)		VI	519,00
PSP201	NA	PLAQUETTE DE FREIN SPECIALE (1)		VI	92,00
PSP202	NA	PLAQUETTES FREIN SPECIALES		VI	SD
PSP203	NA	PLAQUETTES FREIN SPECIALES		VI	SD
PSP204	NA	PLAQUETTES FREIN SPECIALES (4)		VI	296,00
PSP205	NA	PLAQUETTES FREIN SPECIALES		VI	SD
PSP206	NA	PLAQUETTES FREIN SPECIALES (4)		VI	250,00
PSP207	NA	PLAQUETTES FREIN SPECIALES (2)		VI	390,00
PSP208	NA	PLAQUETTES FREIN SPECIALES		VI	SD
PSP209	5,600	PLAQUETTE DE FREIN SPECIALE (1)		VI	50,00
PSP210	2,020	PLAQUETTE DE FREIN SPECIALE (1)		VI	50,00
PSP301	NA	PLAQUETTE DE FREIN SPECIALE (1)		VI	92,00
PSP302	NA	PLAQUETTE DE FREIN SPECIALE (1)		VI	125,00
PSP303	NA	PLAQUETTES FREIN SPECIALES (4)		VI	306,00
PSP304	4,660	PLAQUETTES FREIN SPECIALES (1+1)		VI	200,00
PSP305	NA	PLAQUETTES FREIN SPECIALES		VI	SD
PSP306	18,100	PLAQUETTES FREIN SPECIALES (1+1)		VI	156,00
PSP307	NA	PLAQUETTES FREIN SPECIALES		VI	SD
PSP308	NA	PLAQUETTES FREIN SPECIALES		VI	SD
PSP309	NA	PLAQUETTES FREIN SPECIALES		VI	SD
PSP310	NA	PLAQUETTE DE FREIN SPECIALE (1)		VI	190,00
PSP311	5,240	PLAQUETTES FREIN SPECIALES (1+1)		VI	158,00
PSP401	NA	PLAQUETTES FREIN SPECIALES		VI	SD
PSP402	NA	PLAQUETTES FREIN SPECIALES		VI	SD
PSP403	NA	PLAQUETTES FREIN SPECIALES (1+1)		VI	285,00
PSP404	NA	PLAQUETTES FREIN SPECIALES		VI	SD
RE0100	0,680	RECEPTEUR EMBRAYAGE MERCEDES		VI	80,00
RE0101	0,640	RECEPTEUR EMBRAYAGE IVECO DIA 19,05		VI	50,00
RE0102	1,600	EMETTEUR EMBRAYAGE IVECO		VI	160,00
RE0103	0,580	RECEPTEUR EMBRAYAGE MERCEDES DIA 23,81		VI	68,00
RE0104	NA	RECEPTEUR EMBRAYAGE MERCEDES DIA 28,5		VI	126,00
RE0105	1,300	RECEPTEUR EMBRAYAGE MERCEDES DIA 38,1		VI	188,00
RE0106	0,550	RECEPTEUR EMBRAYAGE IVECO DIA 19,05		VI	84,00
RES001	NA	RESSORT DE MACHOIRES RT	19934, 19935, 19187	VI	8,00
RES002	NA	RESSORT DE MACHOIRES RT	19934, 19935, 19187	VI	5,00
RES004	NA	RESSORT DE MACHOIRES RT	19187	VI	7,00
RES005	0,489	RESSORT DE MACHOIRES DAF	19010;19052;19063;19069	VI	8,00
RES006	0,253	RESSORT DE MACHOIRES SCANIA	19931, 19932, 19933	VI	9,00
RES007	0,261	RESSORT DE MACHOIRES MAN MERCEDES	19495	VI	9,00
RES008	0,190	RESSORT DE MACHOIRES MAN MERCEDES	19495;19496	VI	7,00
RES009	0,170	RESSORT DE MACHOIRES MAN MERCEDES	19495;19496	VI	7,00
RES010	NA	RESSORT AXIAL GRUE PERROT KNOTT DUPLEX		VI	SD
RES011	NA	RESSORT RAPPEL GRUE PERROT KNOTT DUPLEX		VI	SD
RES012	NA	RESSORT RAPPEL GRUE PERROT KNOTT SIMPLEX		VI	SD

REF GIL	Poids	DESIGNATION	OBS	REM	PRIX HT
RIV10.10		NA RIVETS 10-10 NORMES US 6.35X15.87 TETE 13		VI	18,00
RIV408		NA RIVETS 4X8 ST LAITON TP7.5 /100 DIN7338B		VI	6,00
RIV410		NA RIVETS 4X10 ST LAITON TP7.5 /100 DIN7338B		VI	6,00
RIV506TP9.5		NA RIVETS 5X6 TUBULAIRE ACIER TP9.5/1000		VI	70,00
RIV510		NA RIVETS 5X10 ST LAITON TP9.5 /100 DIN7338B		VI	8,00
RIV512		NA RIVETS 5X12 ST LAITON TP11 /100 DIN7338B		VI	12,00
RIV514TP12		NA RIVETS 5X14 ST ACIER TP12 /100		VI	8,00
RIV515		NA RIVETS 5X15 ST LAITON TP11/100 DIN7338B		VI	14,00
RIV515TF		NA RIVETS 4.95X15 SPECIAL SMB TF150° / 100		VI	9,00
RIV516		NA RIVET 5X16 ST LAITON T12/100 DIN7338B		VI	18,00
RIV6.318		NA RIVETS 6.3X18 SPECIAL SCANIA OLD ST/100		VI	19,00
RIV6.517		NA RIVETS 6.5X17.6 ST ACIER DAF /100		VI	18,00
RIV606TP11.5		NA RIVETS 6X6 TUB. ACIER TP11.5/1000		VI	110,00
RIV610		NA RIVETS 6X10 ST LAITON TP11/100 DIN7338B		VI	14,00
RIV612		NA RIVETS 6X12 ST LAITON TP11/100 DIN7338B		VI	14,00
RIV615	0,320	RIVETS 6 X 15 ST LAITON TP12 /100 DIN7338B		VI	20,00
RIV615TP11		NA RIVETS 6X15 TUB. ACIER TP11/100 DIN7338C		VI	15,00
RIV618		NA RIVETS 6X18 ST LAITON TP12 /100 DIN7338B		VI	20,00
RIV812		NA RIVETS 8X12 TUB.ACIER TP15.5/ 100 DIN7338C		VI	24,00
RIV815	0,420	RIVETS 8X15 TUB.ACIER /100 DIN 7338C E DB		VI	12,00
RIV816		NA RIVETS 8X16 ST ACIER IVECO /100		VI	18,00
RIV818	0,440	RIVETS 8X18 TUB.ACIER /100 DIN7338C RENFORCE DB		VI	12,00
RIV818ST		NA RIVETS 8X18 ST ACIER TP 15.5/100 7338B		VI	29,00
RIV820		NA RIVETS 8X20 TUB. ACIER TP15.5/100 DIN7338C DB		VI	24,00
RIV1018	0,540	RIVETS 10X18 TUB. ACIER TP19 /100 DIN 7338C		VI	37,00
RIV1020	0,560	RIVETS 10X20 TUB. ACIER TP19 /100 DIN 7338C		VI	37,00
RIVL09	0,380	RIVETS L9 ST /100 BS3575 6.35X14.29TF12		VI	10,00
RIVL10	0,420	RIVETS L10 ST /100 BS3575 6.35X15.9TF12		VI	12,00
RIVL11	0,460	RIVETS L11 ST /100 BS3575 6.35X17.5TF12		VI	12,00
RIVL12	0,460	RIVETS L12 ST /100 BS3575 6.35X19.1TF12		VI	15,00
RIVS38	0,460	RIVETS S38 (6.6x18) SEMI TUBULAIRE /100		VI	18,00
SUP001		NA SUPPORT DE FREIN RENAULT TRUCKS GAUCHE	19068;19071;19090	VI	560,00
SUP002		NA SUPPORT DE FREIN RENAULT TRUCKS DROIT	19068;19071;19090	VI	560,00
SUP003		NA SUPPORT DE FREIN RENAULT TRUCKS		VI	700,00
SV0001	4,440	SERVO FREIN OPEL, NISSAN, RENAULT		VI	317,00
TF0014	10,760	TAMBOUR FREIN IVECO DAILY		VI	86,00
TF0220	9,640	TAMBOUR FREIN DB		VI	61,00
TF0221	9,640	TAMBOUR FREIN DB		VI	61,00
TF790065	16,000	TAMBOUR FREIN IVECO DAILY 270X80		VI	190,00
TF790476	15,000	TAMBOUR FREIN NISSAN CABTSTAR 280X65		VI	160,00
TU0001	0,020	TEMOIN D'USURE 1ER SERIE		VI	41,00
TU0002	0,048	TEMOIN D'USURE L1310		VI	41,00
TU0003	0,045	TEMOIN D'USURE L955		VI	63,00
TU0010	0,080	TEMOIN D'USURE MAN		VI	37,00
TUK001	0,032	KIT TEMOIN D'USURE		VI	63,00

TEXTAR	Poids	DESIGNATION	OBS	REM	PRIX HT
1302001	NA	JEU GARNITURES MERCEDES 260X055 T017 CO	13020	6	87,60
1503002	1,080	JEU GARNITURES MERCEDES IVECO 270X080 T017 CO	15030	6	55,20
1503003	1,200	JEU GARNITURES MERCEDES IVECO 270X080 T017 +1MM	15030	6	60,70
1505901	1,080	JEU GARNITURES MERCEDES 300X087 T017 CO	15059	6	93,40
1516203	NA	JEU GARNITURES MERCEDES 308X090 D7115 CO	15162	6	SD
1520704	NA	JEU GARNITURES IVECO 400X090 T024 CO	15207	6	SD
1520705	NA	JEU GARNITURES IVECO 400X090 T024 +1MM	15207	6	SD
1520706	NA	JEU GARNITURES IVECO 400X090 T024 +2MM	15207	6	SD
1524701	NA	JEU GARNITURES BPW 400X080 T053 CO	15247	6	SD
1534906	1,321	JEU GARNITURES MERCEDES 300X070 D7115 CO	15349; 15350	6	93,00
1534907	1,381	JEU GARNITURES MERCEDES 300X070 D7115 +0,5MM	15349; 15350	6	102,40
1558008	2,421	JEU GARNITURES MERCEDES304X098 D7115 CO	15580; 15581	6	87,10
1581702	2,211	JEU GARNITURES DAF MAN 325X096,5 T026 CO	15817; 15823	6	127,70
1582602	NA	JEU GARNITURES BPW 310X80 D7121 CO	15827	6	130,00
1583101	7,950	JEU GARNITURES RENAULT TRUCKS 305X070 T0123 CO	15831; 15832	6	78,80
1583102	7,950	JEU GARNITURES RET 305X070 T0123 +1MM	15831; 15832	6	86,60
1587906	3,141	JEU GARNITURES MAN 325X099,5 D7141 CO	15879	6	103,40
1701703	5,601	JEU GARNITURES MAN 360X143 D7141 CO	17017	6	118,50
1701704	6,161	JEU GARNITURES MAN 360X143 D7141 +1MM	17017	6	130,30
1708802	3,151	JEU GARNITURES IVECO 325X120 T088 CO	17088	6	111,50
1708804	3,101	JEU GARNITURES IVECO 325X120 T088 +1MM	17088	6	122,80
1709401	2,841	JEU GARNITURES IVECO 400X100 T024 CO	17094	6	113,20
1709601	2,401	JEU GARNITURES IVECO 300X100 T017 CO	17096	6	70,00
1711501	NA	JEU GARNITURES BPW SAF 400X120 T013 CO	17115	6	SD
1711502	NA	JEU GARNITURES BPW SAF 400X120 T013 +1MM	17115	6	SD
1716101	6,881	JEU GARNITURES SCANIA 413X127 T088 CO	17161	6	160,70
1718401	NA	JEU GARNITURES KAROSA 420X120 D7113 CO	17184	6	SD
1723802	5,701	JEU GARNITURES MERCEDES 410X143 T012 CO	17238 (17683)	6	159,10
1723804	6,241	JEU GARNITURES MERCEDES 410X143 T012 +1MM	17238 (17683)	6	175,10
1723806	5,561	JEU GARNITURES MERCEDES 410X143 T020 CO	17238 (17683)	6	159,10
1727601	5,721	JEU GARNITURES MERCEDES 430X139,5 T088 CO	17276	6	139,40
1727806	2,491	JEU GARNITURES MERCEDES 308X105 D7115 CO	17278 (17927)	6	107,10
1727807	2,681	JEU GARNITURES MERCEDES 308X105 D7115 +1MM	17278 (17927)	6	117,80
1728006	2,851	JEU GARNITURES MERCEDES 308X120 D7115 CO	17280 (17928)	6	134,60
1728007	3,201	JEU GARNITURES MERCEDES 308X120 D7115 +1MM	17280 (17928)	6	148,00
1728008	3,151	JEU GARNITURES MERCEDES 308X120 D7115 +1,5MM	17280 (17928)	6	162,70
1728705	3,150	JEU GARNITURES MERCEDES 308X135 D7115 CO	17287 (17929)	6	145,80
1728706	3,461	JEU GARNITURES MERCEDES 308X135 D7115 +1MM	17287 (17929)	6	160,40
1729004	NA	JEU GARNITURES MERCEDES 364X130 T010 +1MM	17290;17950	6	151,50
1729006	4,151	JEU GARNITURES MERCEDES 364X130 D7115 CO	17290;17950	6	137,70
1729007	4,421	JEU GARNITURES MERCEDES 364X130 D7115 +1MM	17290;17950	6	151,50
1734703	NA	JEU GARNITURES BPW 300X100 T090 CO	17347	6	SD
1735003	1,901	JEU GARNITURES MERCEDES 300X102,5 DON7121 CO	17350;17973	6	103,00
1735004	1,800	JEU GARNITURES MERCEDES 300X102,5 DON7121 +0,5MM	17350;17973	6	113,30
1735103	2,301	JEU GARNITURES MERCEDES 300X122.5 DON7121 CO	17351;17975	6	113,40
1735104	2,341	JEU GARNITURES MERCEDES 300X122.5 DON7121 +0,5MM	17351;17975	6	124,70
1735702	4,491	JEU GARNITURES VOLVO 370X138,7 D7141 CO	17357; 17358	6	144,40
1737707	NA	JEU GARNITURES BPW SAF 420X120 T090 CO	17377	6	SD
1740501	3,651	JEU GARNITURES BPW 410X120 T090 CO	17405	6	115,00
1740805	1,701	JEU GARNITURES WABCO 325X100 T024 CO	17408	6	82,40
1740806	1,951	JEU GARNITURES WABCO 325X100 T024 +1MM	17408	6	90,70
1740909	3,131	JEU GARNITURES MERCEDES 304X135 D7115 CO TH. 12,3	17409	6	103,30
1740910	2,541	JEU GARNITURES MERCEDES 300X135 D7115 CO TH. 10	17409	6	79,30
1748107	4,911	JEU GARNITURES IVECO VAN HOOL 420X125 D7141 CO	17481	6	103,00
1748108	4,911	JEU GARNITURES IVECO VAN HOOL 420X125 D7141 +1MM	17481	6	113,30
1748109	5,561	JEU GARNITURES IVECO VAN HOOL 420X125 D7141 +2MM	17481	6	124,60
1748206	NA	JEU GARNITURES IVECO 420X125 D7141 CO	17482	6	SD

TEXTAR	Poids	DESIGNATION	OBS	REM	HT	PRIX
1748207	NA	JEU GARNITURES IVECO 420X125 D7141 +1MM	17482	6		SD
1748208	NA	JEU GARNITURES IVECO 420X125 D7141 +2MM	17482	6		SD
1766402	NA	JEU GARNITURES VOLVO 412X127 T088 CO	17664	6		SD
1768202	4,781	JEU GARNITURES MERCEDES 410X123 T012 CO	17682	6		159,30
1768801	NA	JEU GARNITURES IVECO 325X140 T011 CO	17688	6		SD
1779501	6,701	JEU GARNITURES MERCEDES 410X143 T016 CO	17795; 17796	6		144,40
1782704	2,501	JEU GARNITURES DAF IVECO RT 325X120 D7115 CO	17827; 17828	6		83,10
1782705	3,100	JEU GARNITURES DAF IVECO RT 325X120 D7115 +1MM	17827; 17828	6		91,40
1783102	2,011	JEU GARNITURES RT 310X125 D7115 CO	17831; 17832	6		70,20
1788802	NA	JEU GARNITURES IKARUS 420X140 T088 CO	17888	6		SD
1790006	3,651	JEU GARNITURES DAF MAN 325X146,5 D7141 CO	17900; 17901	6		164,60
1790007	4,100	JEU GARNITURES DAF MAN 325X146,5 T088 CO	17900; 17901	6		143,10
1792408	2,471	JEU GARNITURES IVECO 325X100 D7141 CO	17924; 17925	6		88,20
1792409	2,651	JEU GARNITURES IVECO 325X100 D7141 +1MM	17924; 17925	6		96,90
1792410	2,761	JEU GARNITURES IVECO 325X100 D7141 +1,5MM	17924; 17925	6		106,60
1798806	4,731	JEU GARNITURES MAN 325X149,5 D7141 CO	17988	6		156,60
1798807	5,181	JEU GARNITURES MAN 325X149,5 D7141 +1MM	17988	6		172,20
1799101	4,431	JEU GARNITURES SCANIA 412X127 T088 CO	17991	6		87,00
1799102	4,501	JEU GARNITURES SCANIA 412X127 G115 CO	17991	6		95,70
1799201	11,200	JEU GARNITURES VOLVO 410X125 T088 CO	17992	6		97,10
1799202	5,691	JEU GARNITURES VOLVO 410X125 G115 CO	17992	6		111,70
1901001	8,001	JEU GARNITURES DAF 420X150 G203 CO	19010; 19011	6		153,60
1901003	8,591	JEU GARNITURES DAF 420X150 G203 +1MM	19010; 19011	6		168,90
1901005	7,941	JEU GARNITURES DAF 420X150 T088 CO	19010; 19011	6		133,60
1901006	8,681	JEU GARNITURES DAF 420X150 T088 +1MM	19010; 19011	6		146,90
1902401	9,000	JEU GARNITURES DAF 419X152,4 G203 CO	19024; 19031	6		335,50
1903001	10,301	JEU GARNITURES ROR 419X178 Q+ T0110 CO	19030; 19033	6		93,00
1903002	10,141	JEU GARNITURES ROR 419X178 Q+ T0110 +1MM	19030; 19033	6		102,30
1903070	36,701	KIT MACHOIRES GARNIES ROR 419X178 Q+ CO	19030	51		283,40
1903230	8,940	JEU GARNITURES BPW SAF 420X180 T099 CO	19032	6		112,90
1903231	9,440	JEU GARNITURES BPW SAF 420X180 T099 +1MM	19032	6		124,20
1903234	8,341	JEU GARNITURES BPW SAF 420X180 T090 CO	19032	6		129,80
1903235	8,801	JEU GARNITURES BPW SAF 420X180 T090 +1MM	19032	6		142,80
1903270	33,451	KIT MACHOIRES GARNIES BPW 420X180 CO	19032	51		280,30
1903271	35,000	KIT MACHOIRES GARNIES BPW ECO 420X180 CO	19032	51		288,10
1903274	39,740	KIT MACHOIRES GARNIES SAF 420X180 CO	19032	51		288,10
1903275	39,740	KIT MACHOIRES GARNIES SAF 420X180 +1MM	19032	51		295,00
1903616	9,001	JEU GARNITURES TRAILOR 419X178 T099 CO TROUS 5MM	19036; 19037	6		103,70
1903617	8,551	JEU GARNITURES TRAILOR 419X178 T099 +1MM	19036; 19037	6		114,10
1903708	8,551	JEU GARNITURES ROR 419X178 T090	19036; 19037	6		119,30
1903712	9,100	JEU GARNITURES ROR 419X178 T099 CO TROUS 6,35MM	19036; 19037	6		103,70
1903713	9,081	JEU GARNITURES ROR 419X178 T099 +1MM	19036; 19037	6		114,10
1903714	9,871	JEU GARNITURES ROR 419X178 T099 +2MM	19036; 19037	6		125,50
1903770	39,740	KIT MACHOIRES GARNIES ROR Q 479X178 T099 CO	19037	51		198,20
1903771	36,101	KIT MACHOIRES GARNIES ROR Q 479X178 T099 +1MM	19037	51		218,00
1904902	4,491	JEU GARNITURES RENAULT 414X150 T088 CO	19049; 19199	6		91,70
1904911	5,320	JEU GARNITURES RENAULT 414X150 T088 +1MM	19049; 19199	6		94,10
1905201	9,251	JEU GARNITURES DAF 420X175 G203 CO	19052; 19055	6		154,50
1906301	10,401	JEU GARNITURES DAF 420X200 G203 CO	19063; 19064	6		208,90
1906302	10,371	JEU GARNITURES DAF 420X200 G203 +1MM	19063; 19064	6		229,70
1906303	10,501	JEU GARNITURES DAF 420X200 T088 CO	19063; 19064	6		181,70
1906304	10,851	JEU GARNITURES DAF 420X200 T088 +1MM	19063; 19064	6		199,90
1906802	9,641	JEU GARNITURES VOLVO 410X225 Z T088 CO	19068	6		128,30
1906805	10,851	JEU GARNITURES VOLVO 410X225 Z T088 +1MM	19068	6		141,10
1906810	9,921	JEU GARNITURES VOLVO 410X225 Z CO G115	19068	6		147,50
1906901	13,200	JEU GARNITURES DAF 420X240 G203	19069; 19077	6		256,50
1907102	9,120	JEU GARNITURES VOLVO 410X200 Z T088 CO	19071	6		123,10

TEXTAR	Poids	DESIGNATION	OBS	REM	PRIX HT
1907105	9,511	JEU GARNITURES VOLVO 410X200 Z T088 +1MM	19071	6	135,30
1907109	8,611	JEU GARNITURES VOLVO 410X200 Z G115 CO	19071	6	141,50
1907502	9,651	JEU GARNITURES SCANIA 413X178 T088 CO	19075	6	132,60
1908101	6,500	JEU GARNITURES BPW T090 TH 12MM	19081	6	260,00
1909002	7,511	JEU GARNITURES RT VOLVO 410X175 Z T088 CO	19090	6	107,80
1909005	8,311	JEU GARNITURES RT VOLVO 410X175 Z T088 +1MM	19090	6	118,70
1909007	7,501	JEU GARNITURES RT VOLVO 410X175 Z G115 CO	19090	6	124,00
1909009	9,300	JEU GARNITURES RT VOLVO 410X175 Z G115 +1MM	19090	6	136,40
1909102	12,251	JEU GARNITURES IVECO PERROT 410X202 D7141 CO	19091; 19098	6	214,70
1909437	9,451	JEU GARNITURES BPW 420X200 T099 CO	19094	6	120,80
1909439	9,651	JEU GARNITURES BPW 420X200 T099 +1MM	19094	6	136,90
1909440	11,160	JEU GARNITURES BPW 420X200 T099 +2MM	19094	6	150,60
1909442	9,301	JEU GARNITURES BPW 420X200 T090 CO	19094	6	138,90
1909443	10,001	JEU GARNITURES BPW 420X200 T090 +1MM	19094	6	157,30
1909444	10,291	JEU GARNITURES BPW 420X200 T090 +2MM	19094	6	173,00
1909470	34,221	KIT MACHOIRES BPW GIGANT 420X200 CO	19094	51	285,90
1909471	39,740	KIT MACHOIRES GARNIES BPW ECO 420X200 CO	19094	51	285,90
1909474	39,740	KIT MACHOIRES SAF 420X200 CO	19094	51	285,90
1909475	39,740	KIT MACHOIRES SAF 420X200 +1MM	19094	51	295,00
1909902	11,121	JEU GARNITURES IVECO PERROT 410X182 D7141 CO	19099; 19100	6	155,00
1910205	NA	JEU GARNITURES BPW SAF 300X150 T013 CO	19102	6	SD
1910301	4,331	JEU GARNITURES BPW SAF 300X200 T013 CO	19103	6	126,00
1910902	10,381	JEU GARNITURES IVECO 410X180 ROC. 2 D7151 CO	19109; 19110	6	92,70
1910903	11,121	JEU GARNITURES IVECO 410X180 ROC. 2 D7151 +1MM	19109; 19110	6	102,00
1911602	11,061	JEU GARNITURES IVECO 410X200 ROC. 2 D7151 CO	19116; 19119	6	92,70
1911603	11,651	JEU GARNITURES IVECO 410X200 ROC. 2 D7151 +1MM	19116; 19119	6	102,00
1915002	8,091	JEU GARNITURES DAF 419X152,4 T088 CO	19150; 19151	6	136,30
1916001	7,261	JEU GARNITURES MERCEDES 440X170 T088 CO	19160	6	145,80
1916002	7,651	JEU GARNITURES MERCEDES 440X170 T088 +1MM	19160	6	160,50
1916602	NA	JEU GARNITURES KAESSBOHRER 400X200 T013 CO	19166	6	SD
1917705	6,291	JEU GARNITURES MAN 360X163 D7141 CO	19177	6	146,80
1918702	11,131	JEU GARNITURES RVI 414X220 T088 CO	19187	6	186,60
1918704	12,051	JEU GARNITURES RVI 414X220 T088 +1,5MM	19187	6	211,50
1918709	11,091	JEU GARNITURES RVI 414X220 CO T0115	19187	6	220,90
1918712	11,811	JEU GARNITURES RVI (BOM) 414X220 D7113 CO	19187	6	220,90
1918714	13,600	JEU GARNITURES RVI (BOM) 414X220 D7113 +1,5MM	19187	6	243,10
1918716	NA	JEU GARNITURES RVI 414X220 T088 +1MM	19187	6	211,50
1919101	7,421	JEU GARNITURES BPW 420X180 KEY LINING T090 CO	19191	6	148,30
1919201	8,891	JEU GARNITURES BPW 420X200 KEY LINING T090 CO	19192	6	153,50
1920005	7,451	JEU GARNITURES BPW SMB 420X160 T090 CO	19200	6	203,70
1922507	5,541	JEU GARNITURES IVECO 360X170 T088 CO	19225	6	98,00
1922508	5,871	JEU GARNITURES IVECO 360X170 T088 +1MM	19225	6	107,70
1922509	6,291	JEU GARNITURES IVECO 360X170 T088 +2MM	19225	6	118,60
1923502	NA	JEU GARNITURES IKARUS RABA 420X180 T088 CO	19235	6	SD
1923601	NA	JEU GARNITURES IKARUS 420X180 T088 CO	19236	6	SD
1925501	5,971	JEU GARNITURES RENAULT TRUCKS 360X170 T0104 CO	19255; 19259	6	119,50
1925502	7,200	JEU GARNITURES 360X170 T0104 +1MM	19255; 19259	6	131,40
1925602	9,131	JEU GARNITURES DAF 419X178 T088 CO	19256; 19260	6	176,20
1926901	4,831	JEU GARNITURES VOLVO 360X170 D7121 CO	19269; 19272	6	122,30
1927901	6,591	JEU GARNITURES MONTENEGRO 311X199,5 T099 CO	19279; 19280	6	159,70
1928304	8,851	JEU GARNITURES SAF 420X180 T090 CO	19283; 19284	6	156,50
1928306	9,511	JEU GARNITURES SAF 420X180 T090 +1MM	19283; 19284	6	172,00
1928307	9,791	JEU GARNITURES SAF 420X180 T090 +2MM	19283; 19284	6	189,20
1928308	10,300	JEU GARNITURES SAF 420X180 T099 CO	19283; 19284	6	136,10
1928309	10,111	JEU GARNITURES SAF 420X180 T099 +1MM	19283; 19284	6	149,70
1928310	9,911	JEU GARNITURES SAF 420X180 T099 +2MM	19283; 19284	6	164,70
1934202	9,771	JEU GARNITURES IVECO 420X180 T088 CO	19342	6	184,30

TEXTAR	Poids	DESIGNATION	OBS	REM	PRIX HT
1934205	12,000	JEU GARNITURES IVECO 420X180 D7141 CO	19342	6	202,70
1934302	10,901	JEU GARNITURES IVECO 420X200 T088 CO	19343	6	223,00
1934304	11,731	JEU GARNITURES IVECO 420X200 T088 +1MM	19343	6	245,30
1934307	11,431	JEU GARNITURES IVECO 420X200 D7141 CO	19343	6	256,40
1936507	9,681	JEU GARNITURES TRAILOR 419X203 T090 CO TROUS 5	19365	6	132,40
1936513	10,031	JEU GARNITURES TRAILOR 419X203 T099 +1MM T. 5	19365	6	126,60
1936515	9,621	JEU GARNITURES TRAILOR 419X203 T099 CO TROUS 5	19365	6	115,20
1936605	9,791	JEU GARNITURES ROR 419X203 T090 CO TROUS 6,35	19366	6	132,40
1936607	9,501	JEU GARNITURES ROR 419X203 T099 CO TROUS 6,35	19366	6	115,20
1936908	10,621	JEU GARNITURES ROR 419X219 T013 CO	19369	6	144,00
1936912	9,951	JEU GARNITURES ROR 419X219 T099 CO	19369	6	125,10
1936913	11,351	JEU GARNITURES ROR 419X219 T099 +1MM	19369	6	137,70
1936914	11,981	JEU GARNITURES ROR 419X219 T099 +2MM	19369	6	151,40
1936970	34,201	KIT MACHOIRES GARNIES ROR 419X219 T099 CO	19369	51	244,20
1936971	34,751	KIT MACHOIRES GARNIES ROR 419X219 T099 +1MM	19369	51	268,60
1938414	8,361	JEU GARNITURES IVECO 381X178 D7141 CO	19384; 19385	6	155,30
1938415	9,121	JEU GARNITURES IVECO 381X178 D7141 +1MM	19384; 19385	6	170,80
1938416	10,350	JEU GARNITURES IVECO 381X178 D7141 +2MM	19384; 19385	6	187,90
1939302	10,831	JEU GARNITURES SCANIA 412,8X203 T088 CO	19393	6	147,50
1939304	13,550	JEU GARNITURES SCANIA 412,8X203 T088 +1MM	19393	6	162,30
1939308	11,181	JEU GARNITURES SCANIA 412,8X203 G115 CO	19393	6	169,50
1941001	7,931	JEU GARNITURES LIAZ 420X150 D7113 CO	19410	6	128,80
1941101	7,071	JEU GARNITURES TATRA 420X160 T088 CO	19411	6	217,00
1941102	7,771	JEU GARNITURES TATRA 420X160 T088 +1MM	19411	6	238,70
1941103	7,941	JEU GARNITURES TATRA 420X160 T088 +2MM	19411	6	262,50
1946101	8,300	JEU GARNITURES MOL YORK 394X210 T099 CO	19461; 19462	6	233,10
1946301	6,561	JEU GARNITURES RT 414X175 T088 CO	19463	6	137,60
1946703	7,791	JEU GARNITURES VOLVO 394X178 D7115 CO	19467; 19468	6	150,70
1947702	11,800	JEU GARNITURES SAF 420X203 T090 CO	19477; 19478	6	131,20
1947704	10,781	JEU GARNITURES SAF 420X203 T090 +1MM	19477; 19478	6	144,40
1947706	11,060	JEU GARNITURES SAF 420X200 T099 CO	19477; 19478	6	119,40
1947707	11,491	JEU GARNITURES SAF 420X200 T099 +1MM	19477; 19478	6	131,30
1947905	8,531	JEU GARNITURES SAF 367X180 T090 CO	19479; 19480	6	148,90
1949005	9,391	JEU GARNITURES SAF 367X200 T090 CO	19490; 19491	6	157,20
1949402	6,451	JEU GARNITURES MERCEDES MAN 410X163 T088 CO	19494	6	130,50
1949404	7,041	JEU GARNITURES MERCEDES MAN 410X163 T088 +1MM	19494	6	143,60
1949405	7,221	JEU GARNITURES MERCEDES MAN 410X163 T088 +2MM	19494	6	157,90
1949407	6,391	JEU GARNITURES MERCEDES MAN 410X163 T012 CO	19494	6	150,10
1949409	7,031	JEU GARNITURES MERCEDES MAN 410X163 T012 +1MM	19494	6	165,00
1949502	7,001	JEU GARNITURES MERCEDES MAN 410X183 T088 CO	19495	6	146,80
1949504	7,841	JEU GARNITURES MERCEDES MAN 410X183 T088 +1MM	19495	6	166,40
1949505	8,161	JEU GARNITURES MERCEDES MAN 410X183 T088 +2MM	19495	6	183,00
1949507	7,151	JEU GARNITURES MERCEDES MAN 410X183 T012 CO	19495	6	173,90
1949509	7,811	JEU GARNITURES MERCEDES MAN 410X183 T012 +1MM	19495	6	191,30
1949510	8,201	JEU GARNITURES MERCEDES MAN 410X183 T012 +2MM	19495	6	210,30
1949511	7,151	JEU GARNITURES MAN 410X183 T020 CO	19495	6	173,90
1949602	8,911	JEU GARNITURES MERCEDES MAN 410X223 T088 CO	19496	6	204,70
1949604	9,571	JEU GARNITURES MERCEDES MAN 410X223 T088 +1MM	19496	6	231,90
1949605	10,001	JEU GARNITURES MERCEDES MAN 410X223 T088 +2MM	19496	6	255,00
1949607	8,841	JEU GARNITURES MERCEDES MAN 410X223 T012 CO	19496	6	242,50
1949609	9,701	JEU GARNITURES MERCEDES MAN 410X223 T012 +1MM	19496	6	266,70
1949610	10,271	JEU GARNITURES MERCEDES MAN 410X223 T012 +2MM	19496	6	293,30
1949611	8,801	JEU GARNITURES MAN 410X223 T020 CO	19496	6	242,50
1950307	6,671	JEU GARNITURES IVECO DAF 360X170 D7121 +1MM	19503	6	153,70
1950308	6,391	JEU GARNITURES IVECO DAF 360X170 D7121 CO	19503	6	139,70
1950309	7,071	JEU GARNITURES IVECO DAF 360X170 D7121 +2MM	19503	6	169,00
1950505	6,601	JEU GARNITURES MERCEDES 364X200 D7115 CO	19505; 19112	6	190,20

TEXTAR	Poids	DESIGNATION	OBS	REM	PRIX HT
1950506	6,951	JEU GARNITURES MERCEDES 364X200 D7115 +1MM	19505; 19112	6	209,30
1950607	5,121	JEU GARNITURES MERCEDES 364X160 D7115 CO	19506; 19845	6	175,90
1950608	5,491	JEU GARNITURES MERCEDES 364X160 D7115 +1MM	19506; 19845	6	193,40
1951508	5,211	JEU GARNITURES SAF KASSBOHRER 300X200 T013 CO	19515; 19516	6	132,90
1951510	5,291	JEU GARNITURES SAF KASSBOHRER 300X200 T013 +1MM	19515; 19516	6	146,20
1951511	5,851	JEU GARNITURES SAF KASSBOHRER 300X200 T013 +2MM	19515; 19516	6	160,70
1951512	5,581	JEU GARNITURES SAF KASSBOHRER 300X200 T099 CO	19515; 19516	6	115,50
1951513	6,040	JEU GARNITURES SAF KASSBOHRER 300X200 T099 +1MM	19515; 19516	6	127,00
1951701	3,701	JEU GARNITURES SAF TRAILOR 300X150 T013 CO	19517; 19518	6	167,70
1954201	9,551	JEU GARNITURES DAF VOLVO 381X200 D7141 CO	19542	6	159,80
1955301	10,831	JEU GARNITURES IVECO 410X200 ROCKW1 D7141 CO	19553; 19554	6	170,00
1955502	9,961	JEU GARNITURES IVECO 410X180 ROCKW1 D7141 CO	19555; 19556	6	155,00
1955708	9,501	JEU GARNITURES SMB 419X203 T090 CO	19557; 19606	6	136,30
1955710	10,061	JEU GARNITURES SMB 419X203 T090 +1MM	19557; 19606	6	149,90
1955713	9,271	JEU GARNITURES SMB 419X203 T099 CO	19557; 19606	6	115,00
1955714	10,551	JEU GARNITURES SMB 419X203 T099 +1MM	19557; 19606	6	130,30
1955770	36,760	KIT MACHOIRES GARNIES SMB 419X203 T099 CO	19557; 19606	51	217,40
1955771	36,991	KIT MACHOIRES GARNIES SMB 419X203 T099 +1MM	19557; 19606	51	239,10
1956002	7,001	JEU GARNITURES VOLVO 413X153 T088 CO	19560; 19561	6	98,00
1956202	8,591	JEU GARNITURES VOLVO 394X203 T088 CO	19562; 19563	6	111,90
1956204	10,081	JEU GARNITURES VOLVO 394X203 T088 +1MM	19562; 19563	6	123,00
1956801	6,621	JEU GARNITURES KASSBOHRER 300X200 T013 CO	19568	6	175,60
1956802	6,761	JEU GARNITURES KASSBOHRER 300X200 T013 +1MM	19568	6	193,20
1957306	5,031	JEU GARNITURES BPW 300X150 T090 CO	19573	6	180,60
1957307	5,441	JEU GARNITURES BPW 300X150 T090 +1,5MM	19573	6	198,60
1957308	5,071	JEU GARNITURES BPW 300X150 T099 CO	19573	6	164,10
1957422	7,680	JEU GARNITURES BPW 300X200 T099 CO	19574	6	196,90
1957424	8,620	JEU GARNITURES BPW 300X200 T099 +1,5MM	19574	6	216,60
1957425	6,941	JEU GARNITURES BPW 300X200 T099 +1MM	19574	6	238,20
1957427	6,401	JEU GARNITURES BPW 300X200 T090 CO	19574	6	203,90
1957428	6,511	JEU GARNITURES BPW 300X200 T090 +1MM	19574	6	226,50
1957429	6,951	JEU GARNITURES BPW 300X200 T090 +2MM	19574	6	249,20
1957430	NA	JEU GARNITURES BPW 300X200 T090 19.5MM	19574	6	249,20
1957431	5,961	JEU GARNITURES BPW 300X200 T099 17MM	19574	6	179,00
1957470	39,740	KIT MACHOIRES GARNIES GIGANT 200	19574	51	306,20
1957471	27,401	KIT MACHOIRES GARNIES GIGANT 200	19574	51	306,20
1957901	7,451	JEU GARNITURES MERCEDES 410X163 T020 CO	19579; 19580	6	206,00
1958101	10,091	JEU GARNITURES MERCEDES 410X223 T020 CO	19581; 19582	6	236,90
1959111	10,301	JEU GARNITURES BPW 420X220 T090 CO	19591	6	172,60
1960408	6,700	JEU GARNITURES ROR 311X190,5 T099 CO	19604; 19605	6	147,50
1960409	6,421	JEU GARNITURES ROR 311X190,5 T099 +1MM	19604; 19605	6	162,20
1960470	24,301	KIT MACHOIRES GARNIES ROR 311X190 CO	19604; 19605	51	301,40
1960870	26,101	KIT MACHOIRES GARNIES SMB 311X203 CO	19608	51	338,30
1961308	8,671	JEU GARNITURES SMB 419X178 T090 CO	19613; 19614	6	128,10
1961310	8,711	JEU GARNITURES SMB 419X178 T090 +1MM	19613; 19614	6	140,90
1961313	8,581	JEU GARNITURES SMB 419X178 T099 CO	19613; 19614	6	111,40
1961314	9,111	JEU GARNITURES SMB 419X178 T099 +1MM	19613; 19614	6	122,70
1961370	34,201	KIT MACHOIRES GARNIES SMB 419X178 T099 CO	19613	51	205,00
1961371	33,411	KIT MACHOIRES GARNIES SMB 419X178 T099 +1MM	19613	51	225,50
1961705	9,650	JEU GARNITURES DAF VAN HOOL 419X203 G203 CO	19617; 19911	6	259,90
1962004	3,401	JEU GARNITURES RT 325X150 D7115 CO	19620; 19621	6	105,20
1962005	3,711	JEU GARNITURES RT 325X150 D7115 +1MM	19620; 19621	6	115,80
1964702	NA	JEU GARNITURES SCANIA 413X254 G115 CO	19647	6	SD
1969901	10,131	JEU GARNITURES MERCEDES 410X220 T016 CO	19699; 19847; 19848	6	237,90
1969902	10,621	JEU GARNITURES MERCEDES 410X220 T016 +1MM	19699; 19847; 19848	6	261,70
1969903	10,141	JEU GARNITURES MERCEDES 410X220 D7113 CO	19699; 19847; 19848	6	237,90
1969905	9,391	JEU GARNITURES MERCEDES 410X220 T088 CO	19699; 19847; 19848	6	206,90

TEXTAR	Poids	DESIGNATION	OBS	REM	PRIX HT
1969906	10,001	JEU GARNITURES MERCEDES 410X220 T088 +1MM	19699;19847;19848	6	227,60
1970601	7,121	JEU GARNITURES MAN MERCEDES 410X163 T088 CO	19706; 19579	6	223,40
1970603	7,371	JEU GARNITURES MAN MERCEDES 410X163 T016 CO	19706; 19579	6	256,90
1970612	7,351	JEU GARNITURES MAN MERCEDES 410X163 D7113 CO	19706; 19579	6	256,90
1970613	7,931	JEU GARNITURES MAN MERCEDES 410X163 D7113 +1MM	19706; 19579	6	282,50
1970618	7,661	JEU GARNITURES MAN MERCEDES 410X163 T088 +1MM	19706; 19579	6	245,70
1970701	9,761	JEU GARNITURES MAN MERCEDES 410X223 T088 CO	19707; 19581	6	272,50
1970702	10,641	JEU GARNITURES MAN MERCEDES 410X223 T088 +1MM	19707; 19581	6	299,70
1970705	10,381	JEU GARNITURES MAN MERCEDES 410X223 T016 CO	19707; 19581	6	313,40
1970714	10,451	JEU GARNITURES MAN MERCEDES 410X223 D7113 CO	19707; 19581	6	313,40
1970715	11,011	JEU GARNITURES MAN MERCEDES 410X223 D7113 +1MM	19707; 19581	6	344,70
1970720	11,251	JEU GARNITURES MAN MERCEDES 410X223 T088 +2MM	19707; 19581	6	329,70
1970803	6,981	JEU GARNITURES MAN 360X182.5 D7121 CO	19708; 19867	6	161,60
1971201	9,401	JEU GARNITURES IVECO 410X220 T011 CO	19712; 19755	6	227,90
1971202	10,051	JEU GARNITURES IVECO 410X220 T011 +1MM	19712; 19755	6	250,70
1971301	6,471	JEU GARNITURES MAN 410X163 T020 CO	19713	6	133,10
1971401	8,981	JEU GARNITURES IVECO 410X180 ROCKWELL 2 T088 CO	19714;19556;19715	6	159,80
1971403	10,001	JEU GARNITURES IVECO 410X180 ROC. 2 T088 +2MM	19714;19556;19715	6	175,70
1971612	10,101	JEU GARNITURES IVECO 410X200 ROC. 2 D7141 CO	19716;19553;19717	6	170,60
1971613	12,250	JEU GARNITURES IVECO 410X200 ROC. 2 D7141 +1MM	19716;19553;19717	6	187,60
1971802	9,401	JEU GARNITURES SMB 360X200 D7122 CO	19718; 19719	6	160,80
1974302	10,341	JEU GARNITURES EVOBUS 410X220 D7113 CO	19743; 19755	6	227,90
1975401	9,100	JEU GARNITURES IVECO 410X 199,5 D7141 CO	19754	6	144,30
1975803	5,171	JEU GARNITURES VOLVO 360X170 D7141 CO	19758; 19759	6	158,30
1975804	5,791	JEU GARNITURES VOLVO 360X170 D7141 +1MM	19758; 19759	6	174,20
1976002	NA	JEU GARNITURES SAE DUPILLIER 305X150 D7122 CO	19760; 19761	6	SD
1976207	5,901	JEU GARNITURES SAE DUPILLIER 305X200 T090 CO	19762; 19763	6	131,40
1976210	6,121	JEU GARNITURES SAE DUPILLIER 305X200 T099 CO	19762; 19763	6	110,90
1976211	6,751	JEU GARNITURES SAE DUPILLIER 305X200 T099 +1MM	19762; 19763	6	125,70
1976270	27,200	KIT MACHOIRES GARNIES SAE DUPILLIER 305X200 CO	19762	51	274,30
1978610	NA	JEU GARNITURES IVECO VAN HOOL 410X200 D7141 CO	19786	6	SD
1978611	NA	JEU GARNITURES IVECO VAN HOOL 410X200 D7141 CO	19786; 19823	6	SD
1978612	NA	JEU GARNITURES IVECO VAN HOOL 410X200 D7141 +1MM	19786; 19823	6	SD
1979901	10,811	JEU GARNITURES VOLVO 394X254 T088 CO	19799; 19800	6	159,00
1979902	NA	JEU GARNITURES VOLVO 394X254 T088 +1MM	19799; 19800	6	SD
1982410	12,650	JEU GARNITURES IVECO 410X220 D7141 CO	19824; 19838	6	186,60
1985502	9,081	JEU GARNITURES KASSBOHRER 410X180 D7113 CO	19855; 19856	6	150,10
1986201	7,600	JEU GARNITURES SMB 311X203 T099 CO	19862; 19863	6	164,90
1986202	7,901	JEU GARNITURES SMB 311X203 T099 +1MM	19862; 19863	6	181,40
1987701	6,300	JEU GARNITURES PEGASO 410X160 T088 CO	19877; 19878	6	107,10
1987901	7,980	JEU GARNITURES PEGASO 410X200 T099 CO	19879; 19881	6	126,70
1988501	11,700	JEU GARNITURES VOLVO 394X240 T088 CO	19885; 19886	6	167,40
1988802	8,301	JEU GARNITURES DAF 420X175 T088 CO	19888; 19889	6	175,80
1989002	9,371	JEU GARNITURES DAF 420X200 T088 CO	19890; 19891	6	166,40
1989004	9,941	JEU GARNITURES DAF 420X200 T088 +1MM	19890; 19891	6	183,10
1989007	9,421	JEU GARNITURES DAF 420X200 G203 CO	19890; 19891	6	190,90
1989208	8,451	JEU GARNITURES SAE SAF 355X200 T099 CO	19892; 19893	6	169,60
1990002	7,231	JEU GARNITURES DAF 420X150 T088 CO	19900; 19901	6	140,30
1990004	8,300	JEU GARNITURES DAF 420X150 T088 +1MM	19900; 19901	6	154,30
1990009	7,061	JEU GARNITURES DAF 420X150 G203 CO	19900; 19901	6	161,30
1990210	7,831	JEU GARNITURES BPW 360X200 T090 CO	19902; 19903	6	173,60
1990212	8,501	JEU GARNITURES BPW 360X200 T090 +1MM	19902; 19903	6	191,00
1990213	8,651	JEU GARNITURES BPW 360X200 T090 +1,5MM	19902; 19903	6	210,00
1990803	7,651	JEU GARNITURES ROR 350X200 T088 CO	19908; 19909	6	104,60
1990804	7,751	JEU GARNITURES ROR 350X200 T088 +0,6MM	19908; 19909	6	115,20
1991201	6,041	JEU GARNITURES SAF 356X150 D7122 CO	19912; 19913	6	140,90
1991403	11,600	JEU GARNITURES DAF 420X240 G203 CO	19914; 19915	6	250,40

TEXTAR	Poids	DESIGNATION	OBS	REM	PRIX HT
1993101	5,531	JEU GARNITURES SCANIA 412,8X178 T088 CO	19931	6	114,00
1993102	6,151	JEU GARNITURES SCANIA 412,8X178 T088 +1MM	19931	6	125,40
1993104	5,941	JEU GARNITURES SCANIA 412,8X178 G115 CO	19931	6	131,10
1993106	6,241	JEU GARNITURES SCANIA 412,8X178 G115 +1MM	19931	6	144,20
1993108	7,200	JEU GARNITURES SCANIA 412,8X178 G115 +2MM	19931	6	158,60
1993201	7,180	JEU GARNITURES SCANIA 412,8X203 T088 CO	19932	6	126,30
1993202	6,971	JEU GARNITURES SCANIA 412,8X203 T088 +1MM	19932	6	143,10
1993204	7,051	JEU GARNITURES SCANIA 412,8X203 G115 CO	19932	6	149,60
1993206	7,081	JEU GARNITURES SCANIA 412,8X203 G115 +1MM	19932	6	164,50
1993208	7,361	JEU GARNITURES SCANIA 412,8X203 G115 +2MM	19932	6	181,00
1993301	9,400	JEU GARNITURES SCANIA 412,8X254 T088 CO	19933	6	154,30
1993304	8,821	JEU GARNITURES SCANIA 412,8X254 G115 CO	19933	6	177,40
1993307	9,261	JEU GARNITURES SCANIA 412,8X254 T088 +1MM	19933	6	169,70
1993402	7,501	JEU GARNITURES RENAULT 414X150 T088 CO	19934	6	131,10
1993409	8,591	JEU GARNITURES RENAULT 414X150 T115 CO	19934	6	150,70
1993410	7,681	JEU GARNITURES RENAULT 414X150 T088 +0,5MM	19934	6	144,20
1993502	8,691	JEU GARNITURES RENAULT 414X175 T088 CO	19935	6	154,10
1993507	8,691	JEU GARNITURES RENAULT 414X175 T104 +1.5MM	19935	6	210,00
1993509	8,881	JEU GARNITURES RENAULT 414X175 T115 CO	19935	6	182,50
1993510	9,061	JEU GARNITURES RENAULT 414X175 T115 +1,5MM	19935	6	200,70
1993511	9,151	JEU GARNITURES RENAULT 414X175 (BOM) D7113 CO	19935	6	182,50
1993513	10,001	JEU GARNITURES RENAULT 414X175 (BOM) D7113 +1,5MM	19935	6	200,70
1993514	9,111	JEU GARNITURES RENAULT 414X175 T088 +0,5MM	19935	6	174,70
1994102	6,651	JEU GARNITURES VOLVO 410X150 T088 CO	19941	6	131,60
1995201	6,251	JEU GARNITURES BPW 360X160 T090 CO	19952; 19953	6	273,20
1995202	6,481	JEU GARNITURES BPW 360X160 T090 +1MM	19952; 19953	6	300,50
1996708	5,671	JEU GARNITURES TRAILOR 300X200 T099 CO	19967; 19968	6	124,50
1996709	5,861	JEU GARNITURES TRAILOR 300X200 T099 +1MM	19967; 19968	6	137,00
1997201	8,731	JEU GARNITURES KAROSA 420X180 D7121 CO	19972	6	146,50
1998101	8,671	JEU GARNITURES ROR VALX 419X117,3 T099 CO	19981; 19982	6	125,20
1998301	10,751	JEU GARNITURES ROR 419X218,7 T099 CO	19983; 19984	6	192,70
2026101	2,001	PLAQUETTES FREIN CITROEN FIAT PEUGEOT	20261	1	102,00
2054701	1,301	PLAQUETTES FREIN DAEWOO OPEL	20547	1	67,10
2078401	2,051	PLAQUETTES FREIN MERCEDES	20784; 29784	1	71,95
2180101	1,751	PLAQUETTES FREIN CITROEN FIAT PEUGEOT	21801	1	103,90
2194502	1,361	PLAQUETTES FREIN SEAT VW	21945	1	80,65
2198003	1,241	PLAQUETTES FREIN RENAULT KANGOO NISSAN KUBISTAR	21980	1	48,20
2208701	2,201	PLAQUETTES FREIN RENAULT VAUXHALL	22087	1	91,70
2302101	1,401	PLAQUETTES FREIN MERCEDES G SPRINTER	23021	1	73,75
2302201	1,801	PLAQUETTES FREIN MERCEDES VITO CLASSE V	23022	1	73,75
2304201	1,751	PLAQUETTES FREIN CITROEN FIAT PEUGEOT	23042	1	72,90
2309902	2,051	PLAQUETTES FREIN OPEL VIVARO RENAULT TRAFIC	23099	1	76,50
2312401	1,500	PLAQUETTES FREIN CITROEN BERLINGO PEUGEOT PARTNER	23124	1	74,95
2313101	1,551	PLAQUETTES FREIN AUDI SKODA VW	23131	1	52,80
2322501	1,301	PLAQUETTES FREIN OPEL COMBO	23225	1	78,05
2341703	0,851	PLAQUETTES FREIN OPEL	23417	1	47,00
2343501	2,241	PLAQUETTES FREIN NISSAN CABSTAR	23435	44	139,75
2350101	1,540	PLAQUETTES FREIN MITSUBISHI CANTER	23501	44	116,55
2355402	0,951	PLAQUETTES FREIN AUDI SEAT VW	23554	1	54,80
2358701	2,201	PLAQUETTES FREIN VW CADDY	23587	1	93,60
2360001	1,631	PLAQUETTES FREIN CITROEN PEUGEOT	23600	1	81,00
2361301	2,101	PLAQUETTES FREIN OPEL RENAULT NISSAN	23613	1	76,15
2366901	1,201	PLAQUETTES FREIN OPEL RENAULT NISSAN	23669	1	76,35
2383201	2,050	PLAQUETTES FREIN OPEL	23832	1	72,50
2390101	1,551	PLAQUETTES FREIN MERCEDES VW	23901	1	69,10
2391401	1,231	PLAQUETTES FREIN VW CADDY	23914	1	69,20
2391701	2,231	PLAQUETTES FREIN FIAT CITROËN PEUGEOT	23917	1	124,90

TEXTAR	Poids	DESIGNATION	OBS	REM	PRIX HT
2391901	2,551	PLAQUETTES FREIN FIAT CITROEN PEUGEOT	23919	44	124,90
2392101	1,381	PLAQUETTES FREIN FIAT CITROEN PEUGEOT	23921	44	103,30
2392103	1,451	PLAQUETTES FREIN NISSAN CABSTAR RENAULT MAXITY	23921	1	103,80
2393001	1,721	PLAQUETTES FREIN RENAULT MEGANE	23930	1	73,50
2397901	1,451	PLAQUETTES FREIN CITROEN NEMO FIAT DOBLO	23979	1	88,50
2398001	1,161	PLAQUETTES FREIN RENAULT NISSAN OPEL	23980	1	75,30
2399002	1,951	PLAQUETTES FREIN MERCEDES CLASSE V SPRINTER VITO	23990	1	82,10
2400701	2,151	PLAQUETTES FREIN MERCEDES VIANO VITO	24007	1	80,00
2400801	0,971	PLAQUETTES FREIN MERCEDES VIANO VITO	24008	1	70,30
2410101	1,501	PLAQUETTES FREIN CITROEN BERLINGO PEUGEOT PARTNER	24101	1	74,70
2413701	1,051	PLAQUETTES FREIN CITROËN FORD JAGUAR	24137	1	73,70
2446501	1,440	PLAQUETTES FREIN FIAT CITROEN PEUGEOT	24465	44	114,90
2446601	2,600	PLAQUETTES FREIN FIAT CITROEN PEUGEOT	24466	44	123,45
2446602	2,600	PLAQUETTES FREIN FIAT CITROEN PEUGEOT	24466	44	126,55
2446801	2,300	PLAQUETTES FREIN CITROEN FIAT PEUGEOT	24468	1	123,55
2446802	2,300	PLAQUETTES FREIN CITROEN FIAT PEUGEOT	24468	1	123,55
2448601	1,351	PLAQUETTES FREIN FORD	24486	1	76,30
2452901	1,700	PLAQUETTES FREIN MITSUBISHI L200	24529	1	107,55
2459501	2,001	PLAQUETTES FREIN CITROEN FIAT PEUGEOT	24595	1	136,00
2473901	1,111	PLAQUETTES FREIN MERCEDES BENZ SPRINTER VW LT +TU	24739	1	79,85
2511201	1,591	PLAQUETTES FREIN MASTER IV	BREMBO; 25112	1	76,50
2514701	2,301	PLAQUETTES FREIN MASTER IV	BREMBO; 25147	1	89,50
2517201	2,151	PLAQUETTES FREIN MASTER IV	BREMBO; 25172	1	77,90
2901105	7,836	PLAQUETTES FREIN IVECO EURO CARGO T3018	ADB3700; 29032	2	109,70
2901201	2,200	PLAQUETTES FREIN IVECO PERROT T3078	29012	2	121,20
2901302	4,050	PLAQUETTES FREIN RT SEE PAM 4X67 T3018	29013	2	99,90
2901602	12,901	PLAQUETTES FREIN IVECO WABCO T456	29016	2	215,30
2901704	4,700	PLAQUETTES FREIN IVECO ZETA T456	29017	2	101,50
2902501	25,000	PLAQUETTES FREIN PERLINI K110 T263	KNORR K110; 29025	2	327,00
2903007	11,077	PLAQUETTES FREIN RT MERITOR D3 T3016	MERITOR D3; 29030	2	188,40
2903009	11,121	PLAQUETTES FREIN KÄSSBOHRER MERITOR D3 T7400	MERITOR D3; 29030	2	216,60
2903024	11,128	PLAQUETTES FREIN RT IRISBUS +TU	MERITOR D3; 29030	52	214,00
2903203	6,010	PLAQUETTES FREIN IVECO BENDIX ADB 4300 T3018	ADB4300; 29032	2	99,60
2903701	1,850	PLAQUETTES FREIN IVECO BREMBO T4136	29037	44	91,15
2903902	4,077	PLAQUETTES FREIN VOLVO MERITOR B FRAME T3018	29039	2	76,90
2904001	2,200	PLAQUETTES FREIN IVECO PERROT T3078	29040	2	125,40
2904101	1,920	PLAQUETTES FREIN IVECO BREMBO T4047	29041	2	99,05
2904303	6,800	PLAQUETTES FREIN RT D2 T3018	29043	2	182,00
2904402	5,712	PLAQUETTES FREIN IRISBUS FR1 SEE PAM P 6.67 T3018	29044	2	150,70
2905301	11,800	PLAQUETTES FREIN KASSBOHRER T3012 +1MM	29053	2	256,10
2905503	4,101	PLAQUETTES FREIN MAN PERROT 1000 VG T3010	29055	2	111,70
2905902	11,750	PLAQUETTES FREIN SCANIA T7400	29059	2	179,40
2906504	4,200	PLAQUETTES FREIN IVECO RT B 2.60 T3018	29065	2	81,90
2906705	4,027	PLAQUETTES FREIN IVECO NISSAN RT T3018	29067	2	88,70
2907102	2,340	PLAQUETTES FREIN RT B90 BENDIX T4136	29071	44	113,80
2907203	8,300	PLAQUETTES FREIN RT R312 BREMBO BIDISC 8 P T3034	29072	2	189,80
2907503	10,313	PLAQUETTES FREIN IVECO BREMBO T3018	29075	2	180,30
2907702	7,600	PLAQUETTES FREIN DAF 55 PERROT 1600 VG T3018	29077	2	228,90
2908302	11,045	PLAQUETTES FREIN MERCEDES MERITOR D3 T3012	29083	2	156,30
2908711	11,750	PLAQUETTES FREIN KASSBOHRER MERCEDES SCANIA T7400	29087	2	184,50
2909006	10,650	PLAQUETTES FREIN IRISBUS RT MERITOR D LISA T3016	29090	2	158,90
2909009	11,121	PLAQUETTES FREIN VOLVO MERITOR D LISA T3034	29090	2	203,50
2909015	11,101	PLAQUETTES FREIN RT IRISBUS +TU	29090	2	199,90
2909104	6,050	PLAQUETTES FREIN DAF RT PAN 17 T3010 +1 MM	29091 (29088)	2	117,40
2909504	8,200	PLAQUETTES FREIN DAF MERCEDES T3016	29095	2	211,20
2909507	8,200	PLAQUETTES FREIN MAN T3010	29095	2	276,80
2909519	8,200	PLAQUETTES FREIN MAN T3050	29095	2	215,30

TEXTAR	Poids	DESIGNATION	OBS	REM	PRIX HT
2909520	8,200	PLAQUETTES FREIN MERCEDES SAF T3060	29095	2	215,30
2909522	8,200	PLAQUETTES FREIN IVECO T3030	29095	2	186,20
2909702	4,300	PLAQUETTES FREIN RT SEE PAM 4X67 T3018	29097	2	153,10
2910004	7,351	PLAQUETTES FREIN RT MERITOR C LISA T3016	29100	2	317,80
2910701	2,800	PLAQUETTES FREIN IVECO PERROT T456	29107	2	234,65
2911303	11,409	PLAQUETTES FREIN MAN MERITOR D ELSA 1 T3010	29113	2	182,10
2911307	10,800	PLAQUETTES FREIN MAN MERITOR D ELSA 1 T3023	29113	2	332,60
2911401	11,800	PLAQUETTES FREIN MAN MERITOR D ELSA 1 T3010 +2 MM	29114	2	200,30
2911402	11,800	PLAQUETTES FREIN MAN MERITOR D ELSA 1 T3023 +2 MM	29114	2	140,00
2912111	2,440	PLAQUETTES FREIN IVECO RT MASCOTT T3035	29121	44	93,55
2912112	2,440	PLAQUETTES FREIN IVECO DAILY I II T3035	29121	44	88,00
2912113	2,450	PLAQUETTES FREIN NISSAN RT MAXITY T3035	29121	44	136,90
2912204	4,054	PLAQUETTES FREIN DAILY 60-65 T3018	29122	2	124,30
2912303	1,731	PLAQUETTES FREIN IVECO DAILY II III T3078	29123	44	91,00
2912307	1,751	PLAQUETTES FREIN FORD TRANSIT AR BREMBO T4014	29123	44	202,10
2912405	7,540	PLAQUETTES FREIN ROR MERITOR DX 195 T3018	29124	2	138,50
2913103	11,561	PLAQUETTES FREIN MAN T3010	29131	2	178,90
2913105	11,557	PLAQUETTES FREIN IRISBUS RENAULT TRUCKS T3016	29131	2	189,10
2913111	10,800	PLAQUETTES FREIN VOLVO D7500	29131	2	178,90
2913115	11,630	PLAQUETTES RENAULT TRUCKS +TU (ex 2913171)	29131	2	214,70
2913401	6,627	PLAQUETTES FREIN UNIMOG PERROT 1300 VG T202	29134	44	277,95
2913606	6,600	PLAQUETTES FREIN VOLVO MERITOR B DUCO D7500	29136	2	128,90
2913706	8,621	PLAQUETTES FREIN VOLVO MERITOR C DUCO T3034	29137	2	152,70
2913801	2,200	PLAQUETTES FREIN IVECO DAILY PERROT T3078	29138	44	121,20
2913901	1,850	PLAQUETTES FREIN IVECO DAILY BREMBO T4136	29139	44	88,50
2914001	1,920	PLAQUETTES FREIN IVECO DAILY BREMBO T4047	29140	44	106,45
2914106	8,200	PLAQUETTES FREIN DAF PAN 19-2 T3010	PAN 19-2; 29141	2	362,90
2914302	10,800	PLAQUETTES FREIN SAE SAF SCANIA HALDEX DB22 T3060	29143	2	199,40
2914812	6,601	PLAQUETTES FREIN MERCEDES RP 2918302	29148	2	170,70
2915001	11,500	PLAQUETTES FREIN IVECO CITYCLASS DX225 T3018	29150	2	317,80
2915102	8,501	PLAQUETTES FREIN VOLVO MERITOR DLE DUCO T3034	29151	2	179,50
2915301	2,251	PLAQUETTES FREIN MERCEDES SPRINTER VW LT T3011	29153	44	92,00
2915901	7,300	PLAQUETTES FREIN DAF WABCO PAN 19-1 T3010	PAN 19-1; 29159	2	185,50
2915906	8,200	PLAQUETTES FREIN SAF WABCO PAN 19-1 T3060	PAN 19-1; 29159	2	185,50
2916002	2,680	PLAQUETTES FREIN IVECO MERCEDES RT BREMBO T4136	29160	44	130,75
2916004	3,000	PLAQUETTES FREIN IVECO MERCEDES RT T4136	29160	44	115,35
2917301	6,760	PLAQUETTES FREIN VOLVO RT MER. ELSA 225-1 T3032	29173	2	307,50
2917303	6,998	PLAQUETTES FREIN RT VOLVO +TU T3032	29173	52	338,30
2917401	9,212	PLAQUETTES FREIN RENAULT TRUCKS VOLVO T3032	29174	2	162,00
2917402	9,062	PLAQUETTES FREIN RENAULT TRUCKS VOLVO T7400	29174	2	182,50
2917403	9,152	PLAQUETTES FREIN RT + TU (EX 2917470)	29174	52	192,00
2917705	7,901	PLAQUETTES FREIN RT VOLVO VGT 195 T7600 HD	VGT 195	2	280,00
2918101	8,200	PLAQUETTES FREIN RT HALDEX DB 19 T3032	29181	2	276,80
2918302	5,821	PLAQUETTES FREIN MERCEDES RP 2914812	29183	2	155,00
2918602	10,342	PLAQUETTES FREIN IVECO BREMBO T3018	29186	2	196,00
2919001	1,551	PLAQUETTES FREIN MERCEDES VW TU+ T3035	29190	44	92,00
2919202	2,671	PLAQUETTES FREIN MERCEDES VW TU+ T3036	29192	44	81,00
2919601	11,000	PLAQUETTES FREIN IVECO KNORR SB7 T3050	29196	2	204,90
2920002	2,881	PLAQUETTES FREIN MERCEDES VW T3036	29200	44	91,00
2920801	1,491	PLAQUETTES FREIN MULTICAR T4136	29208	44	229,00
2921101	NA	PLAQUETTES FREIN ROR (MDP5117) ELSA 225L-2	29211; 29291	2	150,00
2921702	2,440	PLAQUETTES FREIN MERCEDES VW T3035	29217	44	82,00
2922701	7,251	PLAQUETTES FREIN BPW TSB3709 T8200	29227	2	169,10
2922801	8,211	PLAQUETTES FREIN BPW TSB4309 T8200	29228	2	189,60
2922901	2,691	PLAQUETTES FREIN IVECO DAILY III T4136	29229	44	155,20
2922902	2,661	PLAQUETTES FREIN NISSAN RT MAXITY T4136	29229	44	129,75
2923101	2,710	PLAQUETTES FREIN IVECO DAILY III T4136	29231	44	269,50

TEXTAR	Poids	DESIGNATION	OBS	REM	PRIX HT
2923201	2,451	PLAQUETTES FREIN IVECO DAILY III T4136	29232	44	192,50
2923701	1,440	VOIR 2916002	29237	44	138,00
2923801	1,850	PLAQUETTES FREIN MITSUBISHI CANTER T4136	29238; 29248	44	106,10
2924001	3,100	PLAQUETTES FREIN (8) MITSUBISHI CANTER T4136	29240	44	133,80
2924201	3,700	PLAQUETTES FREIN (8) MITSUBISHI CANTER T4136	29242	44	132,35
2924401	9,501	PLAQUETTES FREIN MERCEDES AR KNORR SL7 T3050	29346; 29244; 29245	1	190,00
2924601	10,981	PLAQUETTES FREIN MERCEDES AV KNORR SM7 T3050	29347; 29246; 29247	1	200,00
2924901	4,100	PLAQUETTES FREIN (8) MITSUBISHI CANTER T4136	29249	44	149,65
2925601	5,198	PLAQUETTES FREIN IVECO EURO CARGO BREMBO T3018	29256	2	158,40
2926101	NA	PLAQUETTES FREIN NISSAN AKEBONO	29261; 29262	NA	NA
2926901	8,881	PLAQUETTES FREIN MERCEDES SAF (RP 2915801)	29269	2	189,60
2927201	7,851	PLAQUETTES FREIN RT VOLVO MERITOR 225-1 T7600 HD	29272	2	285,60
2927301	9,800	PLAQUETTES FREIN RT VOLVO MERITOR 225-3 T7600 HD	29273	2	220,30
2927701	9,498	PLAQUETTES FREIN ROR D DUCO D7500 RP2912503	29277	2	230,50
2927801	9,901	PLAQUETTES FREIN IVECO MAN MERCEDES PROTECS T3050	29278	2	192,00
2927802	10,101	PLAQUETTES FREIN DAF KNORR PROTEC S T7400	29278	2	210,00
2927901	10,135	PLAQUETTES FREIN MAN WABCO MAXX22 T3010	29279	2	269,00
2928401	6,500	PLAQUETTES FREIN RT VOLVO MAXX19 T3032	29284	2	237,00
2928501	4,965	PLAQUETTES FREIN RT WABCO PAN/MAXX 17 T3032	29088; 29285	2	191,70
2928502	4,963	PLAQUETTES FREIN DAF MAN WABCO PAN 17 T3010	29088; 29285	2	179,00
2928503	5,005	PLAQUETTES FREIN IVECO RT WABCO PAN 17 T3016	29088; 29285	2	191,70
2928504	4,944	PLAQUETTES FREIN APPLI. BUS WABCO PAN 17 T7400	29088; 29285	2	189,00
2929601	2,600	PLAQUETTES FREIN TOYOTA DYNA SUMITOMO T3035	29296; 29297	2	82,00
2930201	4,201	PLAQUETTES FREIN VOLVO T3018	29302	2	92,00
2930601	7,446	PLAQUETTES FREIN BPW SB3745 SN6 T3030	29306	2	200,00
2930701	9,847	PLAQUETTES FREIN BPW SB4345 SN7 T3030	29307	2	166,00
2930801	8,301	PLAQUETTES FREIN BPW SB4309 SK7 T3030	29308	2	166,00
2931301	7,201	PLAQUETTES FREIN DAF WABCO PAN 19-1 T3010	29159; 29313	2	185,50
2931302	7,221	PLAQUETTES FREIN SAF WABCO PAN 19-1 T3060	29159; 29313	2	185,50
2931303	8,400	PLAQUETTES FREIN APPLI. BUS WABCO PAN 19-1 T7400	29159; 29313	2	189,00
2932001	8,200	PLAQUETTES FREIN MAN T3010 PROTEC S (EX 2909507)	29320	2	232,00
2932002	8,200	PLAQUETTES FREIN MERCEDES T7400 PROTEC S	29320	2	276,80
2932003	7,601	PLAQUETTES FREIN MAN T3050 PROTEC S	29320	2	215,30
2932004	8,200	PLAQUETTES FREIN MERCEDES SAF T3060 PROTEC S	29320	2	158,50
2932005	8,200	PLAQUETTES FREIN IVECO T3030 PROTEC S	29320	2	181,20
2932201	2,981	PLAQUETTES FREIN TOYOTA COASTER BUS T4136	29322	2	140,15
2932403	6,700	PLAQUETTES FREIN MERCEDES UNIMOG ATE T527	29324	44	281,40
2932502	3,800	PLAQUETTES FREIN MERCEDES UNIMOG ATE T527	29325	44	187,90
2932701	2,750	PLAQUETTES FREIN NISSAN RT MAXITY T4136 TU+	29327	44	116,65
2933101	10,500	PLAQUETTES FREIN SCANIA KNORR PRO TECHS T3050	29331	2	201,00
2933102	10,500	PLAQUETTES FREIN SCANIA KNORR PRO TECHS T7400	29331	2	235,40
2933601	8,641	PLAQUETTES FREIN SAF T3060 PAN 22-1	29162	2	194,40
2936101	8,161	PLAQUETTES FREIN DAF MERCEDES PROTECS T3016	29361	2	214,00
2949802	7,200	PLAQUETTES FREIN KASSBOHRER KNORR 2V20 T3018	29498	2	155,80
2958104	1,351	PLAQUETTES FREIN MERCEDES UNIMOG ATE T205 EP15MM	29581	44	84,30
2958105	1,600	PLAQUETTES FREIN MERCEDES UNIMOG ATE T205 EP19MM	29581	44	104,30
2962603	5,500	PLAQUETTES FREIN PERROT T456	29626	2	122,40
2970601	6,700	RPP 2907102	29706	44	157,60
2970602	2,340	PLAQUETTES FREIN RENAULT BENDIX T4047	29706	44	166,05
2974703	12,200	PLAQUETTES FREIN DAF EVOBUS VAN HOOL K85 T456	29747	2	246,50
2976402	6,700	PLAQUETTES FREIN UNIMOG ATE T527 (2 TU)	29764	44	289,80
2976502	3,910	PLAQUETTES FREIN UNIMOG ATE T527 (4 TU)	29765	44	183,65
2983506	4,001	PLAQUETTES FREIN MERCEDES T3018	29835	44	101,20
2998401	2,340	PLAQUETTES FREIN NISSAN BENDIX T4136	29984	44	125,05
2998501	2,340	PLAQUETTES FREIN RT B90 BENDIX T4136	29985	44	125,05
83015702	3,603	KIT FREIN RENAULT MASTER I 254X56 CYL DIA 25.4		49	202,88
84015700	3,660	KIT FREIN PREMONTE RT MASTER 254X56 CYL DIA 25.4		49	284,33

TEXTAR	Poids	DESIGNATION	OBS	REM	PRIX HT
84030602	3,854	KIT FREIN PREMONTE RT MASTER 254X56 CYL DIA 25.4		49	287,50
85000400	0,005	BTE 100 RIVETS 6,3X18		7	7,00
85000500	0,003	BTE 100 RIVETS ST TETE 150 12 CUIVRE ROUGE 5 X 16		7	3,00
85000700	0,005	BTE 100 RIVETS 8X18 ACIER		7	9,00
85002100	0,006	BTE 100 RIVETS ST TP ACIER ZINGUE 6.65 X 18		7	8,00
85002200	0,001	BTE 100 RIVETS TUBULAIRES 8X16 ACIER ZINGUE		7	7,00
86000600	0,500	BTE 100 RIVETS ST TETE PLATE 7.5 LAITON 4 X 6		7	15,70
86000800	0,500	BTE 100 RIVETS ST TETE PLATE 7.5 LAITON 4 X 7		7	1,30
86001500	0,500	BTE 100 RIVETS ST TETE PLATE 9.5 LAITON 5 X 10		7	2,00
86001600	0,500	BTE 100 RIVETS ST TETE PLATE 11 LAITON 5 X 12		7	3,00
86001700	0,500	BTE 100 RIVETS ST TETE PLATE ACIER ZINGUE 5 X 15		7	2,60
86002100	3,000	BTE 100 RIVETS 6,0X10 DIN 7338B		7	4,00
86002200	0,500	BTE 100 RIVETS ST TETE PLATE 11 LAITON 6 X 12		7	5,00
86002300	0,400	BTE 100 RIVETS 6,0X15 DIN 7338B		7	5,00
86002701	0,500	BTE 100 RIVETS ST TP 15 CUIVRE ROUGE 8 X 15		7	8,00
86002801	0,500	BTE 100 RIVETS ST TP 15 CUIVRE ROUGE 8 X 18		7	9,00
87001300	0,500	BTE 100 RIVETS TUB. TP 16 ACIER ZINGUE 6 X 15		7	3,60
87001500	0,400	BTE 100 RIVETS 8X15 DIN 7338C		7	7,00
87002000	0,500	BTE 100 RIVETS TUB. TP 16 ACIER ZINGUE 10 X 18		7	21,50
88000800	0,400	BTE 100 RIVETS ST TF 150° ACIER ZINGUE 6.3 X 16		7	6,00
88000900	0,400	BTE 100 RIVETS ST TF 150° ACIER ZINGUE 6.3 X 17.5		7	7,00
88001000	0,500	BTE 100 RIVETS ST TF 150° ACIER ZINGUE 6.3 X 19.5		7	7,30
91055100	1,191	MACHOIRES PARK DB & VW 160X40 +ACC		5	69,40
91057900	1,481	JEU MACHOIRES PARKING MERCEDES VW 170X40 +ACC		5	69,40
91059000	1,511	JEU MACHOIRES PARKING IVECO 170X42 -ACC		5	91,80
91066700	2,241	JEU MACHOIRES PARK. CITROEN FIAT PEUGEOT 170X42		5	168,00
91066800	1,301	JEU MACHOIRES MERCEDES VW 180X25		5	102,70
91069000	1,761	JEU MACHOIRES PARKING MERCEDES		5	105,30
91076100	0,470	JEU MACHOIRES PARKING MITSUBISHI ISUZU 190X47		5	31,50
91081400	1,583	JEU MACHOIRES PARKING IVECO 170X42 -ACC		5	95,50
92036103	3,641	DISQUE FREIN RENAULT EXPRESS KANGOO		9	41,20
92036203	4,091	DISQUE FREIN NISSAN KUBISTAR RENAULT KANGOO		57	55,00
92048103	4,891	DISQUE FREIN CITROEN BERLINGO PEUGEOT PARTNER		9	54,50
92073703	7,810	DISQUE FREIN CITROEN FIAT PEUGEOT		57	103,00
92073803	7,510	DISQUE FREIN CITROEN FIAT PEUGEOT		57	96,45
92073903	8,550	DISQUE FREIN CITROEN FIAT PEUGEOT		57	96,45
92089103	4,340	DISQUE FREIN CITROEN BERLINGO PEUGEOT PARTNER		9	48,40
92089803	7,691	DISQUE FREIN MERCEDES SPRINTER VARIO VW LT		57	69,00
92097700	7,590	DISQUE FREIN NISSAN OPEL RENAULT MASTER		57	131,90
92100903	5,175	DISQUE FREIN RENAULT KANGOO NISSAN KUBISTAR		9	64,00
92111203	6,931	DISQUE FREIN PEUGEOT		57	63,00
92111503	5,140	DISQUE FREIN CITROEN BERLINGO PEUGEOT PARTNER		9	54,50
92111603	6,881	DISQUE FREIN CITROEN BERLINGO PEUGEOT PARTNER		9	54,50
92115000	7,885	DISQUE FREIN CITROEN FIAT PEUGEOT		9	100,20
92115903	10,551	DISQUE FREIN OPEL MOVANO RENAULT MASTER		57	131,90
92116003	9,051	DISQUE FREIN NISSAN OPEL RENAULT TRAFIC		57	128,00
92116100	7,975	DISQUE FREIN CITROEN FIAT PEUGEOT		57	102,50
92116203	7,751	DISQUE FREIN CITROEN FIAT PEUGEOT		57	104,00
92116300	28,580	DISQUE FREIN BPW		33	212,65
92116400	28,260	DISQUE FREIN BPW		33	225,60
92116500	29,780	DISQUE FREIN BPW		33	216,65
92116603	7,410	DISQUE FREIN CITROEN FIAT PEUGEOT		57	111,50
92116703	8,101	DISQUE FREIN CITROEN FIAT PEUGEOT		57	114,20
92120703	5,885	DISQUE FREIN VW CADDY		9	69,40
92120803	7,701	DISQUE FREIN VW CADDY		9	73,70
92131503	7,075	DISQUE FREIN MERCEDES SPRINTER VW LT		57	59,50
92137503	6,691	DISQUE FREIN MERCEDES VOLKSWAGEN		57	67,20

TEXTAR	Poids	DESIGNATION	OBS	REM	PRIX HT
92137603	7,461	DISQUE FREIN MERCEDES VOLKSWAGEN		57	62,90
92153700	9,670	DISQUE + RLT NISSAN OPEL RENAULT TRAFIC		57	128,00
92155700	8,735	DISQUE FREIN IVECO		57	94,00
92155900	8,975	DISQUE FREIN IVECO DAILY III		57	97,30
92157000	10,160	DISQUE FREIN CITROEN FIAT PEUGEOT		9	100,35
92157200	8,010	DISQUE FREIN CITROEN FIAT PEUGEOT		57	110,60
92157300	10,880	DISQUE FREIN CITROEN FIAT PEUGEOT		57	139,10
92157400	7,475	DISQUE FREIN CITROEN FIAT PEUGEOT		57	108,00
92157500	7,475	DISQUE FREIN CITROEN FIAT PEUGEOT		57	96,50
92157600	7,941	DISQUE FREIN CITROEN FIAT PEUGEOT		57	123,90
92171700	8,831	DISQUE FREIN IVECO DAILY III		57	173,50
92174603	6,600	DISQUE FREIN NISSAN TRADE		57	75,90
92228600	9,620	DISQUE FREIN MASTER IV AV		57	135,60
92228700	6,820	DISQUE FREIN MASTER III AR TRACTION		57	123,00
92228800	7,110	DISQUE FREIN MASTER IV AR R. SIMPLE PROPULSION		57	116,95
92230800	7,955	DISQUE FREIN MASTER III AR R. JUMEELEE PROPULSION		57	115,90
93015500	15,740	DISQUE FREIN MERCEDES		33	78,40
93022600	29,260	DISQUE FREIN KASSBOHRER		33	196,30
93025600	20,800	DISQUE FREIN MERCEDES UNIMOG		33	117,90
93042801	14,180	DISQUE FREIN IVECO		57	190,20
93058100	34,160	DISQUE FREIN KASSBOHRER		33	170,20
93058200	33,260	DISQUE FREIN MERCEDES		33	134,30
93058800	14,600	DISQUE FREIN VOLVO		33	87,10
93066400	16,040	DISQUE FREIN MERCEDES		33	85,60
93067600	33,680	DISQUE FREIN KASSBOHRER		33	207,10
93071800	36,260	DISQUE FREIN MAN		33	143,50
93084000	36,910	DISQUE FREIN BOVA DAF		33	205,00
93084100	13,750	DISQUE FREIN DAF		33	86,00
93084200	14,770	DISQUE FREIN DAF		33	85,90
93084300	16,670	DISQUE FREIN FORD		33	85,10
93084600	21,850	DISQUE FREIN IVECO ZETA		33	95,80
93084700	19,400	DISQUE FREIN IVECO		33	118,20
93084800	14,361	DISQUE FREIN IVECO		33	142,50
93084900	18,771	DISQUE FREIN IVECO		33	87,70
93085000	33,890	DISQUE FREIN IVECO		33	188,60
93085100	33,180	DISQUE FREIN IVECO		33	141,50
93085200	36,210	DISQUE FREIN IVECO		33	135,30
93085300	14,750	DISQUE FREIN MAN		33	99,40
93085400	17,350	DISQUE FREIN MAN		33	119,90
93085500	17,990	DISQUE FREIN MAN		33	119,90
93085600	16,600	DISQUE FREIN MERCEDES		33	134,40
93085900	14,710	DISQUE FREIN RENAULT TRUCKS		33	73,20
93086000	30,010	DISQUE FREIN RENAULT TRUCKS		33	214,90
93086100	32,860	DISQUE FREIN RENAULT TRUCKS		33	214,20
93086200	23,000	DISQUE FREIN RENAULT TRUCKS		33	125,40
93086300	12,900	DISQUE FREIN RENAULT TRUCKS		33	85,90
93086400	14,200	DISQUE FREIN VOLVO		33	149,70
93086500	16,970	DISQUE FREIN VOLVO		33	109,70
93086600	16,920	DISQUE FREIN VOLVO		33	178,40
93086700	35,110	DISQUE FREIN NEOPLAN		33	297,30
93086800	34,661	DISQUE FREIN NEOPLAN		33	297,30
93086900	23,700	DISQUE FREIN MAN		33	119,90
93087000	36,660	DISQUE FREIN MAN		33	143,50
93087100	36,560	DISQUE FREIN MAN		33	208,80
93087200	37,260	DISQUE FREIN MAN		33	143,50
93087800	12,500	DISQUE FREIN MERCEDES		57	123,80
93087900	35,360	DISQUE FREIN KASSBOHRER MERCEDES ACTROS		33	148,50

TEXTAR	Poids	DESIGNATION	OBS	REM	PRIX HT
93088300	33,160	DISQUE FREIN SCANIA		33	234,70
93089600	9,875	DISQUE FREIN IVECO		57	128,50
93095100	15,120	DISQUE FREIN IVECO		57	154,45
93095800	28,780	DISQUE FREIN BPW		33	215,30
93096100	39,110	DISQUE FREIN IVECO RPP 93142900		33	159,70
93101100	18,240	DISQUE FREIN IVECO		33	249,10
93101200	36,760	DISQUE FREIN MERCEDES		33	233,10
93101300	14,650	DISQUE FREIN MERCEDES		33	103,50
93101400	24,890	DISQUE FREIN MERCEDES		33	154,80
93101500	27,930	DISQUE FREIN MERCEDES		33	184,70
93101600	19,900	DISQUE FREIN NEOPLAN		33	130,40
93101700	28,980	DISQUE FREIN SAF		33	177,00
93101800	34,540	DISQUE FREIN SAF (PLUS LIVRABLE)		33	142,50
93101900	39,720	DISQUE FREIN SAF		33	197,80
93102000	39,200	DISQUE FREIN SMB		33	129,20
93102300	15,850	DISQUE FREIN MERCEDES		33	149,30
93102400	15,350	DISQUE FREIN MERCEDES		33	139,50
93104600	8,610	DISQUE FREIN IVECO		57	117,90
93104900	29,480	DISQUE FREIN BPW		33	222,40
93105000	34,310	DISQUE FREIN RENAULT TRUCKS		33	143,50
93105100	47,480	DISQUE FREIN RENAULT TRUCKS		33	278,20
93105500	35,010	DISQUE FREIN VOLVO B12		33	170,20
93105600	25,290	DISQUE FREIN SAF		33	130,70
93105700	27,790	DISQUE FREIN DAF		33	266,50
93117400	6,490	DISQUE FREIN RENAULT		57	140,00
93117600	7,975	DISQUE FREIN RENAULT		57	128,40
93117700	31,290	DISQUE FREIN ROR		33	116,40
93117800	33,400	DISQUE FREIN MERCEDES (PLUS LIVRABLE)		33	170,20
93123403	8,670	DISQUE FREIN MERCEDES		57	79,00
93123503	5,120	DISQUE FREIN MERCEDES		57	67,50
93126900	29,780	DISQUE FREIN BPW		33	206,00
93127000	29,780	DISQUE FREIN BPW		33	222,40
93127100	34,800	DISQUE FREIN BPW		33	215,30
93127200	7,955	DISQUE FREIN IVECO		57	125,40
93127300	15,090	DISQUE FREIN IVECO		57	228,65
93127400	23,870	DISQUE FREIN IVECO		33	141,50
93127500	31,540	DISQUE FREIN IVECO		33	220,40
93127600	31,382	DISQUE FREIN IVECO		33	220,40
93127700	18,070	DISQUE FREIN MAN MERCEDES		33	99,40
93127800	7,210	DISQUE FREIN MERCEDES		33	75,95
93127900	33,490	DISQUE FREIN ROR		33	143,50
93128000	18,070	DISQUE FREIN RENAULT TRUCKS		33	98,80
93128100	15,900	DISQUE FREIN RENAULT TRUCKS		33	93,10
93128200	14,850	DISQUE FREIN VOLVO		33	97,20
93138000	17,200	DISQUE FREIN MAN		33	166,10
93142400	19,120	DISQUE FREIN DAF		33	205,00
93142500	19,980	DISQUE FREIN DAF		33	227,60
93142600	18,050	DISQUE FREIN DAF		33	231,70
93142700	23,920	DISQUE FREIN DAF		33	238,80
93142800	29,540	DISQUE FREIN DAF		33	238,80
93142900	36,920	DISQUE FREIN IVECO		33	298,80
93143100	18,350	DISQUE FREIN MAN		33	164,00
93143203	9,610	DISQUE FREIN MERCEDES VOLKSWAGEN		57	91,50
93143303	7,720	DISQUE FREIN MERCEDES VOLKSWAGEN		57	71,90
93143403	10,510	DISQUE FREIN MERCEDES VOLKSWAGEN		57	73,50
93175400	15,250	DISQUE FREIN IVECO		57	149,20
93177500	7,810	DISQUE FREIN IVECO DAILY III		57	112,20

TEXTAR	Poids	DESIGNATION	OBS	REM	PRIX HT
93177603	10,470	DISQUE FREIN IVECO DAILY III		9	154,35
93177703	13,640	DISQUE FREIN IVECO DAILY III		57	167,00
93185303	7,290	DISQUE FREIN CABSTAR 276 MM 5 TROUS		9	188,60
93186700	35,480	DISQUE FREIN MERCEDES ACTROS SETRA		33	175,00
93191200	NA	DISQUE FREIN MAN		33	NA
93191500	16,350	DISQUE FREIN MERCEDES		33	156,55
93191900	NA	DISQUE FREIN NISSAN		33	NA
93192000	24,020	DISQUE FREIN RENAULT TRUCKS		33	229,50
93192400	NA	DISQUE FREIN RENAULT TRUCKS		33	NA
93192700	40,580	DISQUE FREIN ROR		33	NA
93193000	NA	DISQUE FREIN RENAULT TRUCKS ROR		33	NA
93193200	NA	DISQUE FREIN GIGANT HALDEX		33	NA
93193400	NA	DISQUE FREIN GIGANT SAF		33	NA
93193500	NA	DISQUE FREIN SAF		33	NA
93193700	NA	DISQUE FREIN VAN HOOL		33	NA
93222700	25,090	DISQUE FREIN MAN RENAULT TRUCKS VOLVO		33	105,00
93243000	39,480	DISQUE FREIN VOLVO FL 6 19,5"		33	337,00
93243400	38,260	DISQUE FREIN RT VOLVO ZF	68323012	33	337,00
98012200	0,025	TEMOINS USURE MERCEDES OPTARE		45	9,20
98016800	0,100	TEMOINS USURE MERCEDES (FAT)		45	29,10
98016900	0,100	TEMOINS USURE MERCEDES (FAT)		45	41,10
98017000	0,100	TEMOINS USURE MERCEDES (FAT)		37	61,50
98017002	0,053	TEMOINS USURE MERCEDES (FAT)		37	34,40
98017100	0,100	TEMOINS USURE MERCEDES (FAT) POUR +2 MM		37	61,50
98017102	0,052	TEMOINS USURE MERCEDES (FAT) POUR +2 MM		37	61,50
98017200	0,031	TEMOINS USURE MERCEDES (FAD)		37	17,40
98017600	0,052	TEMOINS USURE MAN (FAD)		37	21,50
98018200	0,005	TEMOINS USURE MERCEDES (FAD)		45	9,00
98021302	0,028	TEMOINS USURE MERCEDES (FAD)		34	14,00
98022000	0,006	TEMOINS USURE MERCEDES (FAD)		45	25,00
98022100	0,029	TEMOINS USURE MERCEDES (FAD)		37	24,60
98022200	0,090	TEMOINS USURE RENAULT TRUCKS (FAD)		37	41,00
98022300	0,044	TEMOINS USURE IVECO (FAD)		37	13,30
98022400	0,049	TEMOINS USURE IVECO (FAD)		37	20,50
98022500	0,028	TEMOINS USURE IVECO (FAD)		37	17,40
98022800	0,034	TEMOINS USURE RT IRISBUS (FAD)		37	30,80
98023400	0,015	TEMOINS USURE RT (FAD)		37	25,60
98023500	0,013	TEMOINS USURE MAN CO & +1MM (FAT)	17238;19495;19496	45	30,80
98023600	0,013	TEMOINS USURE MAN +2MM & +3MM (FAT)	17238;19495;19496	37	30,80
98024100	0,300	TEMOINS USURE RT PERROT (FAD)		37	36,90
98024300	0,034	TEMOINS USURE MAN VAN HOOL (FAD)		37	33,80
98024400	0,042	TEMOINS USURE MAN (FAD)		37	42,00
98024800	0,011	TEMOINS USURE IVECO (FAD)		45	32,60
98025000	0,050	TEMOINS USURE IVECO (FAD)		37	22,60
98025100	0,100	TEMOINS USURE RENAULT TRUCKS (FAD)		37	41,00
98025200	0,052	TEMOINS USURE RENAULT TRUCKS (FAD)		37	41,00
98025300	0,091	TEMOINS USURE IVECO (FAD)		37	41,00
98025400	0,050	TEMOINS USURE DAF SCANIA (FAD)		37	20,50
98025500	0,040	TEMOINS USURE RT IRISBUS (FAD)		37	25,60
98026300	0,004	TEMOINS USURE MERCEDES (FAD)		45	22,10
98026400	0,005	TEMOINS USURE MERCEDES (FAD)		45	36,10
98027500	0,650	TEMOINS USURE RENAULT TRUCKS (FAD)		37	41,00
98027600	0,090	TEMOINS USURE RENAULT TRUCKS (FAD)		37	25,60
98028200	0,090	TEMOINS USURE RT 29173/174/177/169 (FAD)	29173;29174;29177	37	30,80
98028400	0,100	TEMOINS USURE IVECO (FAD)		34	41,80
98028500	0,100	TEMOINS USURE RT MASCOTT (FAD)	29121;	37	30,80
98028600	0,025	TEMOINS USURE DAF (FAD)		37	28,70

TEXTAR	Poids	DESIGNATION	OBS	REM	PRIX HT
98028700	0,061	TEMOINS USURE RENAULT TRUCKS (FAD)		37	12,30
98028800	0,100	TEMOINS USURE SAE SAF LONG 294 (FAD)		37	46,10
98028900	0,100	TEMOINS USURE BPW LONG 682 (FAD)		37	51,30
98031500	0,108	TEMOINS USURE IVECO (FAD)		37	49,20
98031600	0,110	TEMOINS USURE DAF (FAD)		37	42,00
98031700	0,080	TEMOINS USURE MERCEDES (FAD)		45	11,30
98031900	0,014	TEMOINS USURE RENAULT TRUCKS (FAD)		37	25,60
98032000	0,014	TEMOINS USURE MAN (FAD)		37	61,50
98032300	0,016	TEMOINS USURE NEOPLAN (FAD)		37	49,20
98032400	0,070	TEMOINS USURE MAN (FAD)		37	41,00
98033700	0,012	TEMOINS USURE MERCEDES (FAD)		45	11,30
98033800	0,012	TEMOINS USURE MERCEDES (FAD)		45	11,10
98036500	0,016	TEMOINS USURE MERCEDES (FAD)		45	11,30
98040700	0,010	TEMOINS USURE IVECO III (FAD)		45	31,10
98040800	0,010	TEMOINS USURE IVECO (FAD)		45	34,40
98040900	0,010	TEMOINS USURE IVECO (FAD)		45	34,40
98041100	NA	TEMOINS USURE IRISBUS LONG 400MM (FAD)		37	NA
98042200	0,027	TEMOINS USURE IVECO (FAD)		34	53,30
98051100	0,022	TEMOINS USURE IVECO LONG 120MM (FAD)		45	33,20
98051200	0,030	TEMOINS USURE IVECO LONG 295MM (FAD)		45	33,00
CVP013K	NA	PLAQUETTES FREIN DON RT MERITOR D3	29030	50%	188,40
CVP020K	NA	PLAQUETTES FREIN DON D8750 SB7	29202	50%	90,00
CVP023K	NA	PLAQUETTES FREIN DON IRISBUS RT MERITOR D LISA	29090	50%	158,90
CVP036K	NA	PLAQUETTES FREIN DON MERCEDES SAF	29095	50%	215,30
CVP037K	NA	PLAQUETTES FREIN DON ROR D DUCO	29277	50%	263,90
CVP088K	NA	PLAQUETTES FREIN DON IRISBUS RENAULT TRUCKS	29131	50%	189,10
CVP093K	NA	PLAQUETTES FREIN DON BPW SB4345	29307	50%	189,60
CVP094K	NA	PLAQUETTES FREIN DON D7750 BPW SB4309	29308	50%	189,60
CVP100K	NA	PLAQUETTES FREIN RT VOLVO DON D7450	29173	50%	162,00
CVP101K	NA	PLAQUETTES FREIN DON D7450 RENAULT TRUCKS VOLVO	29174	50%	162,00
MDB2803	2,671	PLAQUETTES FREIN MERCEDES VW	29192	44	71,12
MDB2907	2,691	PLAQUETTES FREIN IVECO DAILY III	29229	1	122,71
MDB2908	2,400	PLAQUETTES FREIN IVECO DAILY III	29232	1	150,23
MDB2917	2,691	PLAQUETTES FREIN NISSAN CABSTAR	29229	1	104,43
MDB2918	NA	PLAQUETTES FREIN NISSAN CABSTAR RENAULT MAXITY	23921	1	81,56
WIK538	NA	TEMOINS D'USURE 29174/29173/29177		50%	15,40

TIMKEN	Poids	DESIGNATION	REM	PRIX HT
SET54	0,501	ROULEMENT 25590/25520	VI	68,18
SET68	1,502	ROULEMENT 497/493	VI	114,24
SET74	0,544	ROULEMENT 387A/382A	VI	94,50
SET79	2,504	ROULEMENT 56425/56650	VI	185,43
SET81	NA	ROULEMENT HM88542/10	VI	74,78
SET82	NA	ROULEMENT LM104949/JLM104910	VI	61,42
SET83	NA	ROULEMENT HM803149/10	VI	87,51
SET98	1,15	ROULEMENT 3984/3920	VI	310,68
SET102	0,779	ROULEMENT 3585/3525	VI	103,95
SET103	1,152	ROULEMENT 3982/3920	VI	100,71
SET105	1,075	ROULEMENT 33287/33462	VI	147,06
SET108	NA	ROULEMENT JHM807045/12	VI	182,96
SET109	3,445	ROULEMENT 683/672	VI	280,35
SET110	3,416	ROULEMENT 6379/6320	VI	257,10
SET111	NA	ROULEMENT 48290/48220	VI	559,26
SET113	NA	ROULEMENT HM215249/10	VI	445,24
SET114	NA	ROULEMENT H212749/10	VI	304,43
SET115	NA	ROULEMENT JH415647/10	VI	358,58
SET123	0,926	ROULEMENT 3780/3720	VI	134,73
SET201	0,466	ROULEMENT 368A/362A	VI	98,73
SET210	1,334	ROULEMENT 527/522	VI	172,69
SET212	1,423	ROULEMENT 537/532X	VI	128,10
SET215	2,587	ROULEMENT 575/572X	VI	258,39
SET216	2,49	ROULEMENT 594/592A	VI	197,40
SET226	0,185	ROULEMENT 1380/1328	VI	82,88
SET230	0,481	ROULEMENT 2788/2720	VI	67,74
SET238	NA	ROULEMENT JF4049/10	VI	118,36
SET240	NA	ROULEMENT JW5049-90403	VI	222,35
SET243	NA	ROULEMENT JD6549/10	VI	188,91
SET262	0,978	ROULEMENT 27687/27620	VI	207,47
SET263	0,696	ROULEMENT 28580/28521	VI	105,56
SET271	0,853	ROULEMENT 33889/33822	VI	118,83
SET272	0,881	ROULEMENT 33895/33822	VI	204,78
SET276	1,299	ROULEMENT 39580/39520	VI	131,25
SET278	1,264	ROULEMENT 39581/39520	VI	108,62
SET289	2,259	ROULEMENT 52400/52618	VI	287,04
SET293	1,364	ROULEMENT 55200C/55437	VI	146,58
SET315	NA	ROULEMENT JM205149/10	VI	100,99
SET317	NA	ROULEMENT HM220149/10	VI	287,27
SET320	NA	ROULEMENT JLM508748/10	VI	174,02
SET323	NA	ROULEMENT JHM522649/10	VI	610,05
SET324	NA	ROULEMENT JLM714149/10	VI	162,72
SET325	NA	ROULEMENT JM714249/10	VI	358,12
SET339	NA	ROULEMENT HM911245/10	VI	240,94
SET340	NA	ROULEMENT H913842/10	VI	371,84
SET341	NA	ROULEMENT H913843/10	VI	441,58
SET342	NA	ROULEMENT JLM710949C/10	VI	140,68
SET343	NA	ROULEMENT 27695/27620	VI	227,30
SET349	1,681	ROULEMENT 567/563	VI	199,19
SET361	NA	ROULEMENT JM716649/10	VI	207,90
SET363	NA	ROULEMENT 55175C/55437	VI	140,52
SET365	0,735	ROULEMENT 395A/394A	VI	169,12
SET401	2,008	ROULEMENT 580/572	VI	162,23
SET403	2,323	ROULEMENT 594A/592A	VI	225,75
SET404	2,887	ROULEMENT 598A/592A	VI	217,37
SET405	2,58	ROULEMENT 663/653	VI	211,05
SET408	1,101	ROULEMENT 39590/39520	VI	156,22

TIMKEN	Poids	DESIGNATION	REM	PRIX HT
SET411	1,875	ROULEMENT 47686/47620	VI	189,45
SET412	NA	ROULEMENT HM212047/11	VI	118,39
SET414	NA	ROULEMENT HM218248/10	VI	56,00
SET415	NA	ROULEMENT HM518445/10	VI	76,00
SET416	1,177	ROULEMENT 45291/45220	VI	220,50
SET418	NA	ROULEMENT H715334/11	VI	295,55
SET508	3,148	ROULEMENT 687/672	VI	224,89
SET928	1,308	ROULEMENT 47490/47420	VI	249,50
SET929	3,804	ROULEMENT 759/752	VI	334,50
SET1009	0,433	ROULEMENT 25877/25820	VI	65,65
SET1010	NA	ROULEMENT 27690/27620	VI	163,76
SET1011	0,377	ROULEMENT 28150/28300	VI	126,33
SET1015	0,212	ROULEMENT 30206	VI	30,45
SET1016	0,333	ROULEMENT 30207	VI	38,54
SET1017	0,403	ROULEMENT 30208	VI	67,17
SET1018	0,451	ROULEMENT 30209	VI	59,38
SET1019	0,519	ROULEMENT 30210	VI	60,90
SET1020	0,874	ROULEMENT 30212	VI	87,15
SET1021	1,221	ROULEMENT 30214	VI	166,04
SET1022	NA	ROULEMENT 30216	VI	140,70
SET1023	1,927	ROULEMENT 30217	VI	148,10
SET1024	2,46	ROULEMENT 30218	VI	264,24
SET1025	3,525	ROULEMENT 30220	VI	308,70
SET1026	4,198	ROULEMENT 30221	VI	280,00
SET1029	NA	ROULEMENT 30306	VI	44,35
SET1030	0,53	ROULEMENT 30307	VI	49,92
SET1031	1,944	ROULEMENT 30309	VI	74,87
SET1032	1,96	ROULEMENT 30312	VI	149,10
SET1033	2,41	ROULEMENT 30313	VI	189,00
SET1034	2,82	ROULEMENT 30314	VI	256,73
SET1035	1,837	ROULEMENT 31312	VI	187,95
SET1040	0,23	ROULEMENTS 32010X	VI	92,37
SET1041	0,527	ROULEMENT 32011X	VI	63,00
SET1042	0,624	ROULEMENT 32012X	VI	76,65
SET1043	0,63	ROULEMENT 32013X	VI	104,50
SET1044	0,816	ROULEMENT 32014X	VI	99,75
SET1045	0,94	ROULEMENT 32015X	VI	139,18
SET1046	1,345	ROULEMENT 32016X	VI	314,62
SET1047	1,4	ROULEMENT 32017X	VI	203,06
SET1048	1,83	ROULEMENT 32018X	VI	368,39
SET1049	1,91	ROULEMENT 32019X	VI	193,20
SET1050	1,85	ROULEMENT 32020X	VI	242,58
SET1051	2,53	ROULEMENT 32021X	VI	1 074,08
SET1052	3,13	ROULEMENT 32022X	VI	364,00
SET1053	1,88	ROULEMENT 32024X	VI	357,74
SET1058	0,564	ROULEMENT 32209	VI	104,42
SET1060	0,789	ROULEMENT 32211	VI	80,00
SET1061	1,105	ROULEMENT 32212	VI	151,75
SET1062	1,439	ROULEMENT 32213	VI	180,16
SET1063	1,52	ROULEMENT 32214	VI	114,00
SET1064	1,615	ROULEMENT 32215	VI	225,70
SET1065	2,008	ROULEMENT 32216	VI	100,00
SET1066	2,477	ROULEMENT 32217	VI	196,60
SET1067	3,271	ROULEMENT 32218	VI	120,00
SET1068	3,755	ROULEMENT 32219	VI	438,13
SET1069	4,649	ROULEMENT 32220	VI	437,44
SET1070	5,91	ROULEMENT 32221	VI	320,00

TIMKEN	Poids	DESIGNATION	REM	PRIX HT
SET1071	8,68	ROULEMENT 32224	VI	1 239,78
SET1072	0,222	ROULEMENT 32304	VI	43,26
SET1074	0,527	ROULEMENT 32306	VI	64,35
SET1075	0,748	ROULEMENT 32307	VI	108,40
SET1076	1,06	ROULEMENT 32308	VI	111,53
SET1078	1,353	ROULEMENT 32309	VI	80,00
SET1079	NA	ROULEMENT 32310	VI	54,00
SET1080	2,256	ROULEMENT 32311	VI	154,35
SET1081	2,9	ROULEMENT 32312	VI	629,93
SET1082	3,405	ROULEMENT 32313	VI	245,70
SET1083	4,125	ROULEMENT 32314	VI	277,11
SET1084	5,94	ROULEMENT 32316	VI	904,05
SET1085	1,684	ROULEMENT 32924	VI	210,00
SET1086	0,618	ROULEMENT 33011	VI	102,90
SET1087	0,698	ROULEMENT 33012	VI	208,39
SET1088	2,076	ROULEMENT 33014	VI	205,91
SET1089	1,203	ROULEMENT 33015	VI	120,00
SET1090	2,48	ROULEMENT 33018	VI	200,00
SET1091	2,2	ROULEMENT 33019	VI	180,00
SET1092	2,465	ROULEMENT 33020	VI	200,00
SET1093	2,792	ROULEMENT 33021	VI	271,04
SET1094	3,821	ROULEMENT 33022	VI	200,00
SET1095	3,937	ROULEMENT 33024	VI	415,94
SET1096	0,48	ROULEMENT 33108	VI	75,08
SET1097	0,555	ROULEMENT 33109	VI	76,13
SET1098	0,796	ROULEMENT 33111	VI	96,34
SET1099	0,95	ROULEMENT 33112	VI	121,80
SET1100	1,082	ROULEMENT 33113	VI	138,05
SET1101	1,84	ROULEMENT 33115	VI	200,00
SET1102	1,7	ROULEMENT 33116	VI	84,00
SET1103	2,3	ROULEMENT 33117	VI	170,00
SET1104	2,927	ROULEMENT 33118	VI	208,62
SET1106	0,33	ROULEMENT 33206	VI	68,09
SET1107	0,499	ROULEMENT 33207	VI	89,65
SET1108	0,76	ROULEMENT 33208	VI	109,66
SET1109	0,78	ROULEMENT 33209	VI	83,37
SET1110	0,875	ROULEMENT 33210	VI	99,23
SET1111	1,19	ROULEMENT 33211	VI	150,50
SET1112	1,5	ROULEMENT 33212	VI	187,76
SET1113	1,871	ROULEMENT 33213	VI	56,00
SET1114	2,19	ROULEMENT 33214	VI	319,97
SET1115	2,043	ROULEMENT 33215	VI	231,17
SET1116	2,75	ROULEMENT 33216	VI	100,00
SET1117	3,66	ROULEMENT 33217	VI	629,93
SET1118	NA	ROULEMENT 33885/33822	VI	126,78
SET1119	0,618	ROULEMENT 3490/3420	VI	128,10
SET1121	NA	ROULEMENT 368A/362	VI	91,31
SET1122	NA	ROULEMENT 37431A/37625	VI	244,60
SET1123	0,586	ROULEMENT 387A/382	VI	90,99
SET1124	1,903	ROULEMENT 39580/39528	VI	128,40
SET1125	0,737	ROULEMENT 395S/394A	VI	133,21
SET1126	NA	ROULEMENT 42373/42590	VI	474,27
SET1127	1,768	ROULEMENT 4580/4535	VI	147,71
SET1128	1,876	ROULEMENT 47678/47620	VI	151,88
SET1129	1,635	ROULEMENT 47687/47620	VI	214,40
SET1130	3,432	ROULEMENT 48393/48320	VI	570,65
SET1132	2,259	ROULEMENT 52401/52618	VI	310,32

TIMKEN	Poids	DESIGNATION	REM	PRIX HT
SET1133	1,75	ROULEMENT 5395/5335	VI	348,62
SET1135	2,222	ROULEMENT 575/572	VI	148,05
SET1137	1,995	ROULEMENT 580/572X	VI	211,23
SET1138	1,94	ROULEMENT 594A/592XS	VI	265,55
SET1139	1,963	ROULEMENT 623/612	VI	203,74
SET1140	4,149	ROULEMENT 6460/6420	VI	510,34
SET1141	2,443	ROULEMENT 665/653	VI	326,03
SET1142	2,7	ROULEMENT 68450/68712	VI	415,16
SET1143	NA	ROULEMENT 9278/9220	VI	413,97
SET1144	4,057	ROULEMENT 9285/9220	VI	740,81
SET1146	NA	ROULEMENT H414242/10	VI	426,21
SET1148	NA	ROULEMENT H715332/11	VI	355,83
SET1149	NA	ROULEMENT H715348/11	VI	401,01
SET1150	NA	ROULEMENT HM204043/10	VI	191,10
SET1151	NA	ROULEMENT HM204049/10	VI	127,77
SET1152	NA	ROULEMENT HM212049/10	VI	135,80
SET1157	NA	ROULEMENT HM804848/10	VI	189,40
SET1158	NA	ROULEMENT HM807048/10	VI	181,45
SET1163	NA	ROULEMENT JF6049/10	VI	288,70
SET1164	NA	ROULEMENT JF7049/10	VI	196,22
SET1165	NA	ROULEMENT JF7049A/10	VI	470,07
SET1166	3,656	ROULEMENT JF9549/10	VI	160,00
SET1167	3,062	ROULEMENT JH913848/11	VI	733,06
SET1169	NA	ROULEMENT JHM720249/10	VI	441,00
SET1176	NA	ROULEMENT JM207049/10	VI	145,69
SET1177	NA	ROULEMENT JM207049A/10	VI	160,08
SET1178	NA	ROULEMENT JM511946/10	VI	143,46
SET1179	NA	ROULEMENT JM515649/10	VI	100,00
SET1180	NA	ROULEMENT JM612949/10	VI	234,59
SET1181	NA	ROULEMENT JM716648/10	VI	253,24
SET1182	NA	ROULEMENT JM718149/110	VI	278,64
SET1183	NA	ROULEMENT JM719149/13	VI	248,07
SET1184	NA	ROULEMENT JM822049/10	VI	586,88
SET1191	2,879	ROULEMENT JT9049/10	VI	209,52
SET1192	NA	ROULEMENT JW5549/10	VI	211,64
SET1193	NA	ROULEMENT JW6049/10	VI	190,76
SET1195	NA	ROULEMENT JXC18439CA/JXC18439DA	VI	60,00
SET1196	1,615	ROULEMENT JXC19087CD/JXC19087D	VI	217,68
SET1197	NA	ROULEMENT JXC19087CR-90UB3	VI	1 105,85
SET1199	NA	ROULEMENT JXC25370CA/JXC25370DA	VI	70,22
SET1201	1,121	ROULEMENT JXC25389CC/JXC25389DA	VI	137,90
SET1207	NA	ROULEMENT JXC25716C/D	VI	101,33
SET1208	NA	ROULEMENT JXC25723CH/DD	VI	143,50
SET1210	NA	ROULEMENT JXC25763C/D	VI	105,97
SET1214	0,119	ROULEMENT L44600LA/L44643/L44610	VI	59,37
SET1216	NA	ROULEMENT L910349/10	VI	133,62
SET1227	0,424	ROULEMENT LM806649/LM806610	VI	68,96
SET1231	6,18	ROULEMENT NP078914-90UA1	VI	460,00
SET1237	NA	ROULEMENT NP240581-90UA1 IVECO EURO CARGO 2006-	VI	775,72
SET1242	NA	ROULEMENT NP318274-90UA7 IVECO STRALIS, EUROTEC	VI	440,00
SET1244	2,468	ROULEMENT NP331249/Y32021X	VI	390,27
SET1253	NA	ROULEMENT NP550563/NP546683	VI	712,88
SET1254	2,07	ROULEMENT NP569484/NP644537	VI	182,83
SET1255	3,92	ROULEMENT NP635208/NP160764	VI	463,29
SET1257	NA	ROULEMENT NP694163-90UA4	VI	1 200,00
SET1261	0,89	ROULEMENT NP784953/NP396414	VI	58,91
SET1262	4,19	ROULEMENT NP793154-90UA2	VI	908,16

TIMKEN	Poids	DESIGNATION	REM	PRIX HT
SET1263	4,48	ROULEMENT NP793154-90UA3 IVECO EUROPLIS, VOLVO F	VI	840,35
SET1265	15,892	ROULEMENT NP804861-907A5	VI	1 143,49
SET1273	0,47	ROULEMENT NP909358/NP282407	VI	116,68
SET1274	1,89	ROULEMENT NP942787/NP378089	VI	126,69
SET1275	NA	ROULEMENT NP958644/Y32007X	VI	37,58
SET1276	0,854	ROULEMENT NP972299/NP698197	VI	133,69
SET1277	6,551	ROULEMENT NP995460-90UA2	VI	1 168,65
SET1285	1,658	ROULEMENT XAA32018X	VI	131,51
SET1286	NA	ROULEMENT XAA32217	VI	231,04
SET1287	3,947	ROULEMENT XAA32219	VI	461,10
SET1293	NA	ROULEMENT XC2379CD/XC2379DA	VI	134,08
SET1294	NA	ROULEMENT XC6839CC/JXC6839DC	VI	172,45
SET1296	1,288	ROULEMENT JF5049/10 IVECO, SCANIA	VI	263,60
SET1297	1,194	ROULEMENT JF4549/JF5010 RENAULT TRUCKS	VI	166,11
SET1299	2,473	ROULEMENT FRUEHAUF, GIGANT, SMB, TRAILOR	VI	52,00
SET1300	2,686	ROULEMENT DAF, MAN, MERCEDES-BENZ	VI	293,33
SET1301	2,686	ROULEMENT EVOBUS; KÄSSBOHRER; MERCEDES-BENZ	VI	194,90
SET1303	2,447	ROULEMENT NP315939/33020 DAF	VI	192,96
SET1304	2,836	ROULEMENT NP972022/33216 DAF	VI	166,87
SET1306	2,966	ROULEMENT NP323058/33021 DAF, MAN	VI	257,21
SET1308	3,84	ROULEMENT JF10049/JF10010 DAF, MAN, SCANIA	VI	267,68
SET1309	6,716	ROULEMENT MAN, MERCEDES	VI	678,48
SET1311	3,598	ROULEMENT RENAULT TRUCKS, VOLVO	VI	260,00
SET1312	4,804	ROULEMENT RENAULT TRUCKS, VOLVO	VI	304,00
SET1314	5,932	ROULEMENT RENAULT TRUCKS, VOLVO	VI	368,00
SET2312	4,804	ROULEMENT RENAULT TRUCKS, VOLVO EASY FIT	VI	304,00
SET2314	5,932	ROULEMENT RENAULT TRUCKS, VOLVO EASY FIT	VI	368,00
30203	NA	ROULEMENT CONIQUES ISOCLASS™	VI	25,62
30204	NA	ROULEMENT CONIQUES ISOCLASS™	VI	27,32
30205	0,16	ROULEMENTS DE ROUES ET MOYEUX	VI	30,31
30211	NA	ROULEMENT CONIQUES ISOCLASS™	VI	78,01
30213	1,088	ROULEMENTS DE ROUES ET MOYEUX	VI	114,94
30215	1,312	ROULEMENTS DE ROUES ET MOYEUX	VI	134,46
30219	2,942	ROULEMENTS DE ROUES ET MOYEUX	VI	288,91
30302	NA	ROULEMENT CONIQUES ISOCLASS™	VI	31,43
30303	NA	ROULEMENT CONIQUES ISOCLASS™	VI	31,79
30304	NA	ROULEMENT CONIQUES ISOCLASS™	VI	31,50
30305	0,251	ROULEMENTS DE ROUES ET MOYEUX	VI	36,90
30308	NA	ROULEMENT CONIQUES ISOCLASS™	VI	69,09
30310	1,29	ROULEMENTS DE ROUES ET MOYEUX	VI	106,26
30311	1,8	ROULEMENTS DE ROUES ET MOYEUX	VI	140,94
31308	NA	ROULEMENT CONIQUES ISOCLASS™	VI	99,67
31309	NA	ROULEMENT CONIQUES ISOCLASS™	VI	130,31
31311	1,453	ROULEMENTS DE ROUES ET MOYEUX	VI	180,69
31313	2,26	ROULEMENTS DE ROUES ET MOYEUX	VI	309,40
31315	3,245	ROULEMENTS DE ROUES ET MOYEUX	VI	454,52
32204	NA	ROULEMENT CONIQUES ISOCLASS™	VI	157,17
32205	NA	ROULEMENT CONIQUES ISOCLASS™	VI	165,03
32206	0,29	ROULEMENTS DE ROUES ET MOYEUX	VI	42,20
32207	0,406	ROULEMENTS DE ROUES ET MOYEUX	VI	49,31
32208	0,501	ROULEMENTS DE ROUES ET MOYEUX	VI	55,12
32210	0,595	ROULEMENTS ROUES, MOYEUX ET TRANSMISSION	VI	69,37
32222	6,82	ROULEMENTS DE ROUES ET MOYEUX	VI	703,57
32305	0,571	ROULEMENTS DE ROUES ET MOYEUX	VI	53,06
32317	NA	ROULEMENT CONIQUES ISOCLASS™	VI	702,38
33013	0,505	ROULEMENTS ROUES, MOYEUX ET TRANSMISSION	VI	127,55
33110	0,604	ROULEMENTS DE TRANSMISSION	VI	332,41

TIMKEN	Poids	DESIGNATION	REM	PRIX HT
33114	1,57	ROULEMENTS DE TRANSMISSION	VI	204,43
33205	0,25	ROULEMENTS DE ROUES ET MOYEUX	VI	49,34
512029	NA	MOYEU US	VI	130,98
512154	NA	MOYEU US	VI	116,27
512155	NA	MOYEU US	VI	234,96
512156	NA	MOYEU US	VI	232,77
512157	NA	MOYEU US	VI	538,89
512169	NA	MOYEU US	VI	337,23
512170	NA	MOYEU US	VI	312,72
512220	NA	MOYEU US	VI	167,27
513074	NA	MOYEU US	VI	158,11
513075	NA	MOYEU US	VI	208,98
513089	NA	MOYEU US	VI	188,70
513122	NA	MOYEU US	VI	201,67
513123	NA	MOYEU US	VI	198,96
02473/02420	NA	ROULEMENT CONIQUES SR*	VI	101,54
02474/02420	NA	ROULEMENT CONIQUES	VI	89,69
02475/02420	NA	ROULEMENT CONIQUES SR*	VI	79,29
02872/02820	NA	ROULEMENT CONIQUES	VI	50,70
03062/03162	NA	ROULEMENT CONIQUES	VI	87,81
07087X/07210X	0,128	ROULEMENTS DE ROUES ET MOYEUX	VI	56,15
07100S/07210X	NA	ROULEMENT CONIQUES	VI	52,73
09067/09195	NA	ROULEMENT CONIQUES	VI	55,37
09067/09196	NA	ROULEMENT CONIQUES	VI	57,48
09074/09194	NA	ROULEMENT CONIQUES SR*	VI	49,09
09074/09196	NA	ROULEMENT CONIQUES	VI	51,33
11162/11300	NA	ROULEMENT ROUE	VI	174,03
11590/11520	NA	ROULEMENT CONIQUES	VI	63,98
12580/520	NA	ROULEMENT CONIQUES SR*	VI	55,14
13685/13621	NA	ROULEMENT CONIQUES SIMPLE RANGÉE SR*	VI	60,14
14125A/14274	NA	ROULEMENT CONIQUES SR*	VI	50,28
14130/14276	NA	ROULEMENT CONIQUES SR*	VI	51,56
14132T/14276	NA	ROULEMENT CONIQUES SR*	VI	96,85
14137A/276	NA	ROULEMENT CONIQUES	VI	57,64
14138A/14276	NA	ROULEMENT CONIQUES SIMPLE RANGÉE SR*	VI	50,03
14585/525	NA	ROULEMENT CONIQUES	VI	294,96
15100/245	NA	ROULEMENT ROUE	VI	46,16
15100SR/15245	NA	ROULEMENT CONIQUES SR*	VI	281,18
15103S/243	NA	ROULEMENT CONIQUES	VI	77,84
15106/15245	NA	ROULEMENT CONIQUES SR*	VI	48,73
15112/15245	NA	ROULEMENT CONIQUES SR*	VI	48,13
15112/15250X	NA	ROULEMENT CONIQUES SR*	VI	54,83
15123/15245	NA	ROULEMENT CONIQUES	VI	50,49
15578/520	NA	ROULEMENT CONIQUES	VI	58,80
16150/16283	NA	ROULEMENT CONIQUES	VI	126,27
16150/16284	NA	ROULEMENT ROUE	VI	96,04
18590/18520	NA	ROULEMENT CONIQUES SIMPLE RANGÉE SR*	VI	81,67
18690/18620	0,303	ROULEMENTS DE ROUES ET MOYEUX	VI	70,58
18790/18720	0,403	ROULEMENTS DE ROUES ET MOYEUX SR*	VI	67,88
19150/19268	NA	ROULEMENT CONIQUES SIMPLE RANGÉE SR*	VI	124,45
19150/NP353933	NA	ROULEMENT CONIQUES	VI	157,84
1988/1922	0,204	ROULEMENTS DE ROUES ET MOYEUX	VI	92,35
1994X/1922	NA	ROULEMENT CONIQUES SR*	VI	77,41
21075/21212	NA	ROULEMENT CONIQUES SIMPLE RANGÉE	VI	76,36
23690/23620	NA	ROULEMENT CONIQUES	VI	209,50
24780/24720	NA	ROULEMENT CONIQUES SIMPLE RANGÉE SR*	VI	89,16
24780/24721	NA	ROULEMENT ROUE	VI	102,49

TIMKEN	Poids	DESIGNATION	REM	PRIX HT
25577/25523	NA	ROULEMENT CONIQUES	VI	77,71
25580/25520	0,518	ROULEMENTS DE ROUES ET MOYEUX	VI	65,78
25584/25520	NA	ROULEMENT CONIQUES SR*	VI	62,18
25590/25521	NA	ROULEMENT CONIQUES	VI	74,98
2580/2520	0,383	ROULEMENTS DE TRANSMISSION	VI	109,68
2580A/2520A	NA	ROULEMENT ROUE	VI	111,94
2585/2523S	NA	ROULEMENT CONIQUES SR*	VI	306,94
25877/25821	NA	ROULEMENT ROUE	VI	62,04
26881/26824	0,602	ROULEMENTS DE TRANSMISSION SR*	VI	105,32
2788/2729	NA	ROULEMENT CONIQUES SIMPLE RANGÉE	VI	76,90
27880/27820	NA	ROULEMENT CONIQUES	VI	103,64
2789/2720	0,42	ROULEMENTS ROUES, MOYEUX ET TRANSMISSION	VI	70,74
2789/2729	0,424	ROULEMENTS DE TRANSMISSION	VI	80,68
28137/28317	NA	ROULEMENT CONIQUES SR*	VI	360,64
28682/622	NA	ROULEMENT CONIQUES SR*	VI	93,24
28985/920	NA	ROULEMENT CONIQUES SR*	VI	125,96
29580/520	NA	ROULEMENT CONIQUES SR*	VI	169,53
29586/29520	NA	ROULEMENT ROUE	VI	175,27
29675/29620	NA	ROULEMENT CONIQUES SIMPLE RANGÉE	VI	126,22
29685/29620	NA	ROULEMENT CONIQUES SIMPLE RANGÉE	VI	134,48
31593/31520	NA	ROULEMENT CONIQUES	VI	90,48
3188S/3120	NA	ROULEMENT CONIQUES SR*	VI	593,17
32004X	NA	ROULEMENT CONIQUES ISOCCLASS™	VI	31,50
32005X	NA	ROULEMENT CONIQUES ISOCCLASS™	VI	31,22
32006X	0,2	ROULEMENTS DE ROUES ET MOYEUX	VI	35,81
32007X	NA	ROULEMENT CONIQUES ISOCCLASS™	VI	38,48
32008X	0,235	ROULEMENTS DE ROUES ET MOYEUX	VI	44,13
32009X	0,35	ROULEMENTS DE ROUES ET MOYEUX	VI	50,64
32028X	NA	ROULEMENT CONIQUES ISOCCLASS™	VI	775,52
32205B	NA	ROULEMENT CONIQUES	VI	60,15
32206B	NA	ROULEMENT CONIQUES ISOCCLASS™	VI	123,34
32308B	1,203	ROULEMENTS DE ROUES ET MOYEUX	VI	158,11
32309B	1,337	ROULEMENTS DE ROUES ET MOYEUX	VI	233,77
32312B	NA	ROULEMENT CONIQUES ISOCCLASS™	VI	935,78
33262A/33461	1,222	ROULEMENTS DE TRANSMISSION SR*	VI	192,94
33275/33462	NA	ROULEMENT CONIQUES SIMPLE RANGÉE SR*	VI	148,80
33275/33472	1,476	ROULEMENTS DE TRANSMISSION SR*	VI	149,09
33281/33472	1,105	ROULEMENTS ROUES/ MOYEUX SR*	VI	172,27
3386/3325	0,64	ROULEMENTS DE TRANSMISSION	VI	123,33
33889/33821	NA	ROULEMENT CONIQUES SR*	VI	122,23
34306/34478	NA	ROULEMENTS DE TRANSMISSION	VI	133,24
344/332	NA	ROULEMENTS DE TRANSMISSION SR*	VI	85,76
359S/354X	NA	ROULEMENT CONIQUES	VI	248,07
36690/36620	NA	ROULEMENT CONIQUES SIMPLE RANGÉE SR*	VI	398,20
368A/362AX	NA	ROULEMENT CONIQUES SR*	VI	168,19
37425/625	NA	ROULEMENT CONIQUES SIMPLE RANGÉE	VI	279,59
3778/3720	0,975	ROULEMENTS ROUES/ MOYEUX	VI	95,56
3782/3720	0,894	ROULEMENTS DE ROUES ET MOYEUX	VI	89,49
386A/382A	NA	ROULEMENT CONIQUES SR*	VI	87,49
3877/3820	NA	ROULEMENT CONIQUES	VI	97,35
3879/3820	NA	ROULEMENT CONIQUES SR*	VI	150,83
387A/382S	NA	ROULEMENT CONIQUES	VI	93,54
387AS/382A	NA	ROULEMENT CONIQUES	VI	81,30
3880/3820	0,855	ROULEMENTS ROUES/ MOYEUX SR*	VI	95,09
390A/394A	NA	ROULEMENT CONIQUES SR*	VI	91,58
39236/39412	NA	ROULEMENT CONIQUES SIMPLE RANGÉE SR*	VI	177,24
395/394A	NA	ROULEMENT CONIQUES SR*	VI	101,69

TIMKEN	Poids	DESIGNATION	REM	PRIX HT
39585/39520	NA	ROULEMENT ROUE	VI	144,23
3977/3920	NA	ROULEMENTS ROUES/ MOYEUR SR*	VI	158,40
3980/3920	NA	ROULEMENT CONIQUES SR*	VI	122,16
3982/3925	1,355	ROULEMENTS ROUES/ MOYEUR SR*	VI	124,56
3994/3920	NA	ROULEMENT CONIQUES	VI	119,50
418/414	NA	ROULEMENT CONIQUES	VI	133,11
420/414	NA	ROULEMENT CONIQUES SR*	VI	132,82
42375/42584	NA	ROULEMENT CONIQUES SIMPLE RANGÉE SR*	VI	254,83
42376/584	NA	ROULEMENT CONIQUES	VI	251,79
42381/584	NA	ROULEMENT CONIQUES	VI	243,35
42687/42620	1,358	ROULEMENTS ROUES, MOYEUR ET TRANSMISSION	VI	208,34
42690/42620	1,315	ROULEMENTS ROUES/ MOYEUR SR*	VI	221,76
43125/43312	NA	ROULEMENT CONIQUES SR*	VI	106,19
4395/4335	NA	ROULEMENT CONIQUES SR*	VI	212,97
44162/348	NA	ROULEMENT CONIQUES SR*	VI	114,93
45285/45220	NA	ROULEMENT ROUE SR*	VI	128,73
45285A/45220B	1,398	ROULEMENTS DE TRANSMISSION	VI	691,90
462/453X	NA	ROULEMENT CONIQUES SIMPLE RANGÉE	VI	132,95
47487/47420	1,343	ROULEMENTS DE ROUES ET MOYEUR	VI	251,38
48385/320	NA	ROULEMENT CONIQUES	VI	497,72
48685/620	NA	ROULEMENT CONIQUES SR*	VI	611,76
49175/368	NA	ROULEMENTS ROUES/ MOYEUR SR*	VI	280,21
495/492A	NA	ROULEMENT CONIQUES SIMPLE RANGÉE SR*	VI	184,85
49585/49520	NA	ROULEMENT CONIQUES SR*	VI	143,04
497/492A	1,418	ROULEMENTS DE ROUES ET MOYEUR SR*	VI	153,11
497A/492A	NA	ROULEMENTS DE TRANSMISSION	VI	169,06
52375/52618	2,508	ROULEMENTS DE ROUES ET MOYEUR	VI	363,87
52393/618	NA	ROULEMENT CONIQUES SR*	VI	340,33
528/522	1,215	ROULEMENTS DE TRANSMISSION SR*	VI	137,06
529X/522	NA	ROULEMENT CONIQUES SR*	VI	154,43
53176/53375	1,043	ROULEMENTS ROUES/ MOYEUR SR*	VI	127,41
53178/53375	0,93	ROULEMENTS ROUES/ MOYEUR	VI	156,37
53178/53377	NA	ROULEMENT CONIQUES	VI	266,36
535/532A	1,722	ROULEMENTS ROUES/ MOYEUR SR*	VI	301,08
55175/55437	1,32	ROULEMENTS DE TRANSMISSION SR*	VI	198,85
55187/55443	1,286	ROULEMENTS ROUES/ MOYEUR SR*	VI	602,11
55187C/55443	1,617	ROULEMENTS DE TRANSMISSION SR*	VI	199,55
55200/55437	NA	ROULEMENT ROUE SR*	VI	207,35
555S/552A	NA	ROULEMENT CONIQUES SR*	VI	188,67
558/552A	2,278	ROULEMENTS ROUES/ MOYEUR	VI	207,53
5583/5535	2,656	ROULEMENTS DE ROUES ET MOYEUR	VI	321,86
5584/5535	2,164	ROULEMENTS ROUES/ MOYEUR SR*	VI	269,92
559/552A	2,175	ROULEMENTS DE ROUES ET MOYEUR	VI	228,19
560/552A	1,751	ROULEMENTS ROUES/ MOYEUR SR*	VI	181,11
56426/56650	2,401	ROULEMENTS ROUES/ MOYEUR SR*	VI	438,57
566/563	1,777	ROULEMENTS DE ROUES ET MOYEUR	VI	180,39
580X/572	NA	ROULEMENT CONIQUES SR*	VI	240,92
582/572	2,006	ROULEMENTS DE ROUES ET MOYEUR	VI	196,49
593/592A	NA	ROULEMENT CONIQUES	VI	224,51
594/593X	2,426	ROULEMENTS ROUES/ MOYEUR SR*	VI	260,45
598/592A	2,45	ROULEMENTS DE ROUES ET MOYEUR	VI	241,61
5BC/6	NA	ROULEMENT CONIQUES SR*	VI	34,76
5BC/6CE	NA	ROULEMENT CONIQUES	VI	55,76
6386/6320	3,337	ROULEMENTS DE ROUES ET MOYEUR	VI	393,29
6391/6320	NA	ROULEMENT CONIQUES SR*	VI	724,73
641/632	NA	ROULEMENT CONIQUES	VI	269,40
64450/64700	NA	ROULEMENTS DE ROUES ET MOYEUR	VI	407,21

TIMKEN	Poids	DESIGNATION	REM	PRIX HT
645/632	NA	ROULEMENT CONIQUES SR*	VI	260,74
65200/65500	NA	ROULEMENT CONIQUES SR*	VI	296,07
65237/65500	2,428	ROULEMENTS ROUES/ MOYEUX SR*	VI	243,97
65390/65320	2,092	ROULEMENTS DE TRANSMISSION	VI	322,52
6581X/6535	4,3	ROULEMENTS DE ROUES ET MOYEUX	VI	1 917,69
66200/66462	1,578	ROULEMENTS ROUES/ MOYEUX SR*	VI	202,24
663/652	NA	ROULEMENT CONIQUES SR*	VI	270,07
665A/653	NA	ROULEMENT CONIQUES	VI	255,86
665X/653X	2,64	ROULEMENTS ROUES/ MOYEUX	VI	1 329,24
67390/67322	4,236	ROULEMENTS DE ROUES ET MOYEUX SR*	VI	597,00
681A/672	3,587	ROULEMENTS ROUES/ MOYEUX SR*	VI	314,21
685/672	3,874	ROULEMENTS ROUES/ MOYEUX SR*	VI	324,79
72200C/72487	2,023	ROULEMENTS DE TRANSMISSION	VI	198,14
72212C/72487	1,98	ROULEMENTS DE TRANSMISSION	VI	218,70
72218C/72487	1,871	ROULEMENTS ROUES/ MOYEUX SR*	VI	216,93
72225C/487	NA	ROULEMENT CONIQUES	VI	216,09
740/742	NA	ROULEMENT CONIQUES SR*	VI	327,85
74550/74850	5,74	ROULEMENTS ROUES/ MOYEUX SR*	VI	812,47
748S/742	3,373	ROULEMENTS ROUES/ MOYEUX SR*	VI	372,41
749A/742	3,108	ROULEMENTS ROUES/ MOYEUX SR*	VI	308,22
757/752	NA	ROULEMENT CONIQUES SR*	VI	386,68
782/772	5,316	ROULEMENTS ROUES/ MOYEUX SR*	VI	486,07
78214/78551	2,902	ROULEMENTS DE TRANSMISSION SR*	VI	487,53
78215C/78551	NA	ROULEMENT CONIQUES	VI	365,44
78225/78551	2,403	ROULEMENTS DE TRANSMISSION SR*	VI	390,14
78250/78551	NA	ROULEMENT CONIQUES SR*	VI	335,75
861/854	NA	ROULEMENT ROUE SR*	VI	648,74
H414245X/10	NA	ROULEMENTS ROUES/ MOYEUX SR*	VI	474,06
H414249/10	NA	ROULEMENTS DE ROUES ET MOYEUX	VI	284,73
H715341/11	NA	ROULEMENT CONIQUES SR*	VI	309,25
H715343/11	NA	ROULEMENT CONIQUES SR*	VI	324,69
H715345/11	NA	ROULEMENTS DE TRANSMISSION SR*	VI	317,76
H715347/11	NA	ROULEMENTS DE TRANSMISSION SR*	VI	436,97
H913849/10	NA	ROULEMENTS ROUES/ MOYEUX SR*	VI	446,48
H916642/10	NA	ROULEMENT CONIQUES SR*	VI	1 552,95
H917849/10	NA	ROULEMENT CONIQUES SR*	VI	1 846,81
HH221431/10	NA	ROULEMENTS ROUES/ MOYEUX SR*	VI	1 242,70
HH221449/10	NA	ROULEMENT CONIQUES	VI	847,49
HH224335/10	NA	ROULEMENTS ROUES/ MOYEUX SR*	VI	1 387,13
HM212047/10	NA	ROULEMENTS ROUES/ MOYEUX SR*	VI	137,90
HM212049/11	NA	ROULEMENTS ROUES/ MOYEUX SR*	VI	116,35
HM218248Z/10	NA	ROULEMENTS ROUES/ MOYEUX	VI	2 903,75
HM220149Z/110Z	NA	ROULEMENTS ROUES/ MOYEUX	VI	390,96
HM515749/16	NA	ROULEMENTS ROUES/ MOYEUX SR*	VI	546,73
HM516449C/10	NA	ROULEMENT ROUE SR*	VI	229,96
HM624749/10	NA	ROULEMENT ROUE SR*	VI	935,73
HM801346/10	NA	ROULEMENTS DE TRANSMISSION	VI	150,42
HM801346X/10	0,469	ROULEMENTS DE ROUES ET MOYEUX	VI	102,22
HM803146/10	NA	ROULEMENT CONIQUES SIMPLE RANGÉE	VI	107,59
HM804840/10	NA	ROULEMENT CONIQUES SR*	VI	131,24
HM804842/10	NA	ROULEMENTS DE TRANSMISSION	VI	153,15
HM804843/10	NA	ROULEMENTS DE TRANSMISSION	VI	128,23
HM804846/10	NA	ROULEMENT CONIQUES SR*	VI	116,01
HM807035/10	NA	ROULEMENT ROUE SR*	VI	251,13
HM807040/10	NA	ROULEMENTS DE TRANSMISSION	VI	184,11
HM807046/10	NA	ROULEMENTS DE TRANSMISSION	VI	178,58
HM807049/10	NA	ROULEMENTS DE ROUES ET MOYEUX	VI	186,46

TIMKEN	Poids	DESIGNATION	REM	PRIX HT
HM813839/10	NA	ROULEMENTS DE TRANSMISSION	VI	312,95
HM813840/10	NA	ROULEMENTS DE TRANSMISSION SR*	VI	281,98
HM813841/10	NA	ROULEMENTS DE ROUES ET MOYEUX	VI	264,37
HM813841/11	NA	ROULEMENT CONIQUES	VI	264,37
HM813842/10	NA	ROULEMENT CONIQUES SR*	VI	235,16
HM813844/10	NA	ROULEMENTS ROUES/ MOYEUX SR*	VI	210,23
HM813849/10	NA	ROULEMENTS DE ROUES ET MOYEUX	VI	267,16
HM813849/11	NA	ROULEMENT CONIQUES	VI	288,43
HM88547/10	NA	ROULEMENT CONIQUES SR*	VI	81,31
HM88644/10	NA	ROULEMENT CONIQUES	VI	120,62
HM88648/10	NA	ROULEMENT CONIQUES	VI	68,73
HM88649/10	NA	ROULEMENT ROUE	VI	58,78
HM88649A/13	NA	ROULEMENT CONIQUES	VI	109,08
HM89249/10	NA	ROULEMENT ROUE SR*	VI	83,52
HM89446/10	NA	ROULEMENT CONIQUES	VI	74,67
HM89448/10	NA	ROULEMENTS DE ROUES ET MOYEUX	VI	95,59
HM89449/10	NA	ROULEMENTS DE ROUES ET MOYEUX	VI	76,84
HM903245/10	NA	ROULEMENT CONIQUES SR*	VI	199,05
HM903249/10	NA	ROULEMENTS DE ROUES ET MOYEUX	VI	139,83
HM905843/10	NA	ROULEMENTS ROUES/ MOYEUX SR*	VI	247,73
HM907643/14	NA	ROULEMENTS DE ROUES ET MOYEUX SR*	VI	327,18
HM911242/10	NA	ROULEMENTS DE TRANSMISSION SR*	VI	370,29
HM911244/10	NA	ROULEMENT CONIQUES SIMPLE RANGÉE SR*	VI	371,43
J28577/20	NA	ROULEMENT CONIQUES	VI	1 449,49
JH211749/10	NA	ROULEMENTS DE ROUES ET MOYEUX	VI	257,04
JH217249/10	NA	ROULEMENTS ROUES/ MOYEUX SR*	VI	488,22
JH307749/10	NA	ROULEMENT ROUE SR*	VI	255,29
JH415647A/10	NA	ROULEMENT CONIQUES SR*	VI	325,33
JH913848/11	NA	RPP SET1167	VI	624,28
JHM318448/10	NA	ROULEMENT CONIQUES SR*	VI	361,03
JHM516849/10	NA	ROULEMENTS ROUES/ MOYEUX SR*	VI	308,13
JHM803148/113B	NA	ROULEMENT CONIQUES SIMPLE RANGÉE SR*	VI	262,98
JL22349F/10	NA	ROULEMENT CONIQUES	VI	24,36
JL68145/111Z	NA	ROULEMENT CONIQUES	VI	44,73
JL69345/310Z	NA	ROULEMENT CONIQUES SIMPLE RANGÉE SR*	VI	69,38
JL69349/10	NA	ROULEMENT CONIQUES	VI	38,44
JL69349A/10	NA	ROULEMENT CONIQUES SIMPLE RANGÉE	VI	43,78
JL69349X/10	NA	ROULEMENT CONIQUES	VI	49,60
JL819349/10	NA	ROULEMENT CONIQUES SIMPLE RANGÉE	VI	180,04
JLM104945/910Z	NA	ROULEMENT CONIQUES	VI	114,62
JLM104948/10	NA	ROULEMENTS DE TRANSMISSION SR*	VI	65,05
JLM506849/10	NA	ROULEMENT CONIQUES SIMPLE RANGÉE SR*	VI	99,44
JLM704649/10	NA	ROULEMENT CONIQUES SR*	VI	68,15
JM716649/615	NA	ROULEMENT ROUE	VI	196,07
JM718149A/10	NA	ROULEMENTS ROUES, MOYEUX ET TRANSMISSION	VI	80,00
JM720249/10	NA	ROULEMENTS ROUES/ MOYEUX SR*	VI	333,82
JM738249/10	NA	ROULEMENTS ROUES/ MOYEUX SR*	VI	1 306,68
JP10049/10	NA	ROULEMENTS DE ROUES ET MOYEUX SR*	VI	316,53
JP12049/10	NA	ROULEMENTS DE ROUES ET MOYEUX	VI	333,15
JP12049A/10	NA	ROULEMENT CONIQUES	VI	375,74
JP13049A/010	NA	ROULEMENT ROUE SR*	VI	619,54
JP14049/10	NA	ROULEMENTS DE ROUES ET MOYEUX	VI	1 048,98
JW4549/10	NA	ROULEMENT CONIQUES SIMPLE RANGÉE	VI	122,09
JW5049/10	NA	ROULEMENTS DE TRANSMISSION	VI	762,80
JW7049/10	NA	ROULEMENTS DE ROUES ET MOYEUX	VI	313,48
JW7549/10	NA	ROULEMENT ROUE	VI	605,93
JW8049/10	NA	ROULEMENT CONIQUES	VI	517,48

TIMKEN	Poids	DESIGNATION	REM	PRIX HT
JXC18437CA/Y32008X	NA	ROULEMENT CONIQUES SIMPLE RANGÉE	VI	62,64
JXC25678CA/Y32011X	NA	ROULEMENT CONIQUES SIMPLE RANGÉE SR*	VI	97,52
JXC25690C/DC	NA	ROULEMENTS ROUES/ MOYEUX SR*	VI	325,97
JXC25743C/D	NA	ROULEMENT CONIQUES SR*	VI	131,04
JXC25769C/10	NA	ROULEMENT ROUE	VI	126,94
L102849/10	NA	ROULEMENT ROUE SR*	VI	277,19
L225849/10	NA	ROULEMENT ROUE SR*	VI	432,02
L44643/10	NA	ROULEMENT ROUE	VI	31,90
L44649/10	NA	ROULEMENT CONIQUES SIMPLE RANGÉE	VI	29,66
L45449/10	NA	ROULEMENTS DE ROUES ET MOYEUX	VI	23,10
L507949/10	NA	ROULEMENT CONIQUES SIMPLE RANGÉE SR*	VI	239,27
L623149/10	NA	ROULEMENT ROUE SR*	VI	481,85
L624549/10	NA	ROULEMENT ROUE SR*	VI	672,15
L68149/10	NA	ROULEMENTS DE ROUES ET MOYEUX	VI	36,73
L68149/11	NA	CÔNE INDIVIDUEL	VI	35,28
LL319349/10	NA	ROULEMENT ROUE	VI	207,48
LL52549/10	NA	ROULEMENT CONIQUES SIMPLE RANGÉE SR*	VI	112,10
LM102949/10	NA	ROULEMENT ROUE	VI	45,05
LM102949/11	NA	ROULEMENT CONIQUES SR*	VI	56,54
LM104949/11	NA	ROULEMENT CONIQUES	VI	59,72
LM11749/10	NA	ROULEMENT CONIQUES SIMPLE RANGÉE	VI	23,01
LM117949/10	NA	ROULEMENT CONIQUES SR*	VI	970,48
LM11949/10	NA	ROULEMENTS DE ROUES ET MOYEUX	VI	24,91
LM12749/10	NA	ROULEMENTS DE ROUES ET MOYEUX	VI	31,38
LM12749/11	NA	ROULEMENT ROUE	VI	31,46
LM29748/10	NA	ROULEMENT CONIQUES	VI	62,24
LM29748/700LA	NA	ROULEMENT CONIQUES SIMPLE RANGÉE	VI	64,96
LM29749/10	NA	ROULEMENTS DE ROUES ET MOYEUX	VI	41,74
LM300849/11	NA	ROULEMENTS ROUES, MOYEUX ET TRANSMISSION	VI	44,02
LM300849/16	NA	ROULEMENT CONIQUES SIMPLE RANGÉE	VI	63,44
LM48548/10	NA	ROULEMENTS ROUES, MOYEUX ET TRANSMISSION	VI	38,48
LM48548/14	NA	ROULEMENT CONIQUES	VI	132,78
LM48548C/10	NA	ROULEMENT CONIQUES	VI	50,12
LM501349/10	NA	ROULEMENTS DE ROUES ET MOYEUX	VI	46,74
LM501349/11	NA	ROULEMENT CONIQUES SR*	VI	67,46
LM501349/14	NA	ROULEMENT CONIQUES SIMPLE RANGÉE	VI	49,45
LM501349/310A	NA	ROULEMENT CONIQUES SR*	VI	46,72
LM503349/10	NA	ROULEMENT ROUE	VI	52,60
LM503349A/10	NA	ROULEMENTS DE TRANSMISSION	VI	50,43
LM503349A/319	NA	ROULEMENT CONIQUES	VI	62,30
LM522548/10	NA	ROULEMENTS ROUES/ MOYEUX SR*	VI	392,73
LM522549/10	NA	ROULEMENTS ROUES/ MOYEUX SR*	VI	381,40
LM603049/11	NA	ROULEMENT CONIQUES SIMPLE RANGÉE SR*	VI	54,97
LM603049/12	NA	ROULEMENT CONIQUES	VI	51,60
LM67010BCE/K143252	NA	ROULEMENT CONIQUES SIMPLE RANGÉE	VI	32,33
LM67048/010BA	NA	ROULEMENT CONIQUES SR*	VI	111,14
LM67048/014X	NA	ROULEMENT CONIQUES SR*	VI	36,98
LM67048/10	NA	ROULEMENTS DE ROUES ET MOYEUX SR*	VI	31,51
LM67048/14	NA	ROULEMENT CONIQUES SR*	VI	42,55
LM72849F/10	NA	ROULEMENT CONIQUES	VI	71,02
LM78349/310A	NA	ROULEMENTS DE TRANSMISSION	VI	54,66
LM78349/310C	NA	ROULEMENT CONIQUES	VI	57,25
LM814849/10	NA	ROULEMENT CONIQUES SIMPLE RANGÉE SR*	VI	150,58
M12649/10	NA	ROULEMENT CONIQUES SIMPLE RANGÉE	VI	35,45
M802048/11	NA	ROULEMENTS DE ROUES ET MOYEUX	VI	72,95
M804049/10	NA	ROULEMENT ROUE SR*	VI	93,19
M84249/210	NA	ROULEMENT ROUE SR*	VI	102,72

TIMKEN	Poids	DESIGNATION	REM	PRIX HT
M84548/10	NA	ROULEMENT CONIQUES	VI	47,71
M86647/610	NA	ROULEMENT ROUE	VI	67,19
M86649/10	NA	ROULEMENTS DE ROUES ET MOYEURS SR*	VI	45,55
M88040/10	NA	ROULEMENT CONIQUES SR*	VI	65,19
M88043/10	NA	ROULEMENT CONIQUES	VI	51,91
M88046/10	NA	ROULEMENT CONIQUES SR*	VI	58,86
M88048/10	NA	ROULEMENTS DE ROUES ET MOYEURS SR*	VI	50,11
NP027538/NP510716	NA	ROULEMENT CONIQUES SIMPLE RANGÉE	VI	59,74
NP078914-90UA4	NA	UNIPAC™ SR*	VI	520,08
NP113979/NP693852	NA	ROULEMENT CONIQUES	VI	77,65
NP144863/NP294963	NA	ROULEMENT ROUE	VI	47,48
NP182140/NP645406	NA	ROULEMENT CONIQUES SIMPLE RANGÉE SR*	VI	92,28
NP282175/NP953787	NA	ROULEMENT CONIQUES SIMPLE RANGÉE	VI	92,40
NP285701/NP341513	NA	ROULEMENT ROUE	VI	33,39
NP326808/NP806712	NA	CÔNE INDIVIDUEL	VI	157,37
NP347723/NP414027	NA	ROULEMENTS ROUES/ MOYEURS	VI	137,17
NP353549/NP673396	NA	CÔNE INDIVIDUEL	VI	119,34
NP390444/NP750997	NA	ROULEMENT CONIQUES SR*	VI	93,28
NP414535/NP655898	1,979	ROULEMENTS ROUES/ MOYEURS	VI	185,25
NP416359/NP147197	NA	ROULEMENT CONIQUES SIMPLE RANGÉE	VI	104,18
NP417384/Y30206CM	NA	ROULEMENT CONIQUES SIMPLE RANGÉE	VI	42,74
NP449291/NP420308	NA	CÔNE INDIVIDUEL	VI	59,91
NP457992/NP926068	NA	ROULEMENT ROUE	VI	107,03
NP460743/NP266185	NA	ROULEMENT ROUE	VI	56,55
NP528108/NP621196	0,531	ROULEMENTS ROUES/ MOYEURS	VI	113,71
NP547288/NP478159	1,1	ROULEMENTS DE ROUES ET MOYEURS	VI	210,19
NP548549/NP419272	NA	CÔNE INDIVIDUEL SR*	VI	68,34
NP643665/NP577891/K157522	NA	ROULEMENT ROUE	VI	47,12
NP692885/NP948363	NA	ROULEMENT CONIQUES	VI	119,78
NP694163-90UA3	NA	UNIPAC™	VI	1 413,79
NP697136/NP592766	NA	ROULEMENT CONIQUES SIMPLE RANGÉE	VI	81,45
NP702249/L45410Z	NA	ROULEMENT ROUE	VI	28,74
NP718852/NP022178	NA	ROULEMENT ROUE	VI	33,39
NP727209/NP106970	NA	ROULEMENT CONIQUES SIMPLE RANGÉE	VI	NA
NP765903/NP525508	NA	ROULEMENT ROUE	VI	40,17
NP823007/NP735186	NA	ROULEMENT CONIQUES	VI	238,24
NP837197/NP863447	NA	ROULEMENT CONIQUES CUVETTE DOUBLE	VI	69,21
NP850232/JXC10238DF	NA	ROULEMENT CONIQUES SIMPLE RANGÉE	VI	100,23
NP867201/NP646352	NA	ROULEMENT ROUE SR*	VI	49,00
NP897593/NP857890	NA	CÔNE INDIVIDUEL	VI	56,32
NP957403/NP120839	NA	ROULEMENT ROUE	VI	119,28
T101	NA	ROULEMENT ROUE	VI	25,49
T119	NA	BUTÉE	VI	26,72
T126	NA	ROULEMENT ROUE	VI	22,31
T127	NA	BUTÉE	VI	55,87
T1381	NA	ROULEMENT ROUE	VI	102,70
T139	NA	BUTÉE	VI	26,42
T149	NA	BUTÉE	VI	47,60
T163	NA	BUTÉE	VI	83,20
T199	NA	BUTÉE	VI	37,47
U298/U261L	NA	ROULEMENT CONIQUES SIMPLE RANGÉE	VI	76,09
U399/U360L	0,327	ROULEMENTS DE ROUES ET MOYEURS	VI	55,96
XC2253CB/LM48514XP	NA	ROULEMENT CONIQUES	VI	113,71
XC2414CD/HM88610	NA	ROULEMENT CONIQUES SR*	VI	117,44

TIMKEN	Poids	DESIGNATION	REM	PRIX HT
NTN				
HDS001	11	ROULEMENT CASSETTE	VI	430,00
HDS002	5	ROULEMENT CASSETTE	VI	278,00
HDS003	NA	ROULEMENT CASSETTE	VI	276,00
HDS005	NA	ROULEMENT CASSETTE	VI	578,00
N.2209.F206.A	NA	ROULEMENT TRANSMISSION	VI	138,00
R141.41	NA	ROULEMENT CASSETTE	VI	190,00

AUTRE MARQUE

RC2329	NA	ROULEMENT MERCEDES ACTROS	VI	149,00
RC3551	0,986	ROULEMENT CASSETTE DAILY	VI	120,00
RC3552	1,418	ROULEMENT CASSETTE DAILY	VI	120,00
RC3662	0,837	ROULEMENT CASSETTE DAILY	VI	120,00
RC5038	NA	ROULEMENT CASSETTE MERCEDES ACTROS	VI	251,00
RC5377	NA	ROULEMENT CASSETTE MAN	VI	412,00
RC5408	NA	ROULEMENT CASSETTE MAN	VI	298,00
RC5411	NA	ROULEMENT CASSETTE MAN	VI	398,00

TIMKEN	REM	PRIX HT	TIMKEN	REM	PRIX HT	TIMKEN	REM	PRIX HT	TIMKEN	REM	PRIX HT
6000	VI	7,43	6009-ZZC3	VI	33,85	6202-2RSC3	VI	10,88	6211-2RSC3	VI	66,89
6000-2RS	VI	9,68	6010	VI	33,78	6202C3	VI	8,51	6211C3	VI	52,03
6000-2RSC3	VI	9,60	6010-2RS	VI	43,91	6202-ZZ	VI	9,64	6211NR	VI	74,35
6000C3	VI	7,82	6010-2RSC3	VI	43,91	6202-ZZC3	VI	9,64	6211-ZZ	VI	59,26
6000-ZZ	VI	8,53	6010-ZZ	VI	38,83	6203	VI	9,43	6211-ZZC3	VI	59,26
6000-ZZC3	VI	8,53	6010-ZZC3	VI	39,25	6203-2RS	VI	12,26	6212	VI	63,70
6001	VI	7,96	6011	VI	43,14	6203-2RSC3	VI	12,26	6212-2RS	VI	82,81
6001-2RS	VI	10,40	6011-2RS	VI	56,11	6203-2RSNR	VI	20,29	6212-2RSC3	VI	82,81
6001-2RSC3	VI	10,40	6011C3	VI	45,23	6203C3	VI	9,57	6212C3	VI	63,70
6001-ZZ	VI	9,20	6011-ZZ	VI	49,62	6203-ZZ	VI	10,79	6212-ZZ	VI	73,20
6001-ZZC3	VI	9,20	6012	VI	49,47	6203-ZZC3	VI	10,79	6212-ZZC3	VI	73,20
6002	VI	8,73	6012-2RS	VI	64,24	6203-ZZNR	VI	16,33	6213	VI	91,72
6002-2RS	VI	11,41	6012C3	VI	57,40	6204	VI	11,07	6213-2RS	VI	117,76
6002-2RSC3	VI	11,41	6012-ZZ	VI	56,94	6204-2RS	VI	14,40	6213-2RSC3	VI	119,50
6002-ZZ	VI	10,07	6013	VI	63,94	6204-2RSC3	VI	14,40	6213C3	VI	91,72
6002-ZZC3	VI	10,22	6013-2RS	VI	79,40	6204C3	VI	11,07	6213-ZZ	VI	109,23
6003	VI	9,21	6013-2RSC3	VI	80,24	6204-ZZ	VI	12,63	6213-ZZC3	VI	109,23
6003-2RS	VI	11,98	6013-ZZ	VI	73,57	6204-ZZC3	VI	12,63	6214	VI	105,64
6003-2RSC3	VI	11,98	6014	VI	81,13	6205	VI	12,88	6214-2RS	VI	130,56
6003-ZZ	VI	10,63	6014-2RS	VI	100,32	6205-2RS	VI	16,81	6214C3	VI	105,64
6003-ZZC3	VI	10,79	6015	VI	92,94	6205-2RSC3	VI	16,81	6214-ZZ	VI	125,13
6004	VI	10,23	6015-2RS	VI	115,01	6205C3	VI	13,08	6214-ZZC3	VI	125,13
6004-2RS	VI	13,30	6015C3	VI	92,40	6205-ZZ	VI	14,85	6215	VI	124,89
6004-2RSC3	VI	13,30	6015-ZZ	VI	106,89	6205-ZZC3	VI	14,85	6215-2RS	VI	154,45
6004-2RSNR	VI	21,58	6016	VI	113,09	6206	VI	17,28	6215-2RSC3	VI	156,72
6004C3	VI	10,77	6016-2RS	VI	139,61	6206-2RS	VI	22,42	6215C3	VI	124,89
6004NR	VI	21,90	6016C3	VI	113,09	6206-2RSC3	VI	22,42	6215-ZZ	VI	148,03
6004-ZZ	VI	11,76	6017	VI	126,81	6206C3	VI	17,46	6215-ZZC3	VI	148,03
6004-ZZC3	VI	11,76	6017-2RS	VI	162,77	6206-ZZ	VI	19,87	6216	VI	146,13
6005	VI	11,73	6017-ZZ	VI	145,60	6206-ZZC3	VI	19,87	6216-2RS	VI	180,69
6005-2RS	VI	15,27	6017-ZZC3	VI	144,76	6207	VI	22,76	6216C3	VI	146,13
6005-2RSC3	VI	15,27	6018	VI	150,66	6207-2RS	VI	29,56	6216-ZZ	VI	173,28
6005C3	VI	12,36	6018-2RS	VI	193,45	6207-2RSC3	VI	29,56	6216-ZZC3	VI	173,28
6005-ZZ	VI	13,49	6018-ZZ	VI	173,27	6207-2RSNR	VI	62,79	6217	VI	183,50
6005-ZZC3	VI	13,71	6019	VI	174,92	6207C3	VI	22,76	6217-2RS	VI	238,47
6006	VI	14,41	6019-2RS	VI	224,45	6207ZC3	VI	29,53	6217C3	VI	183,50
6006-2RS	VI	18,71	6019-ZZ	VI	204,86	6207-ZZ	VI	26,18	6217-ZZ	VI	211,26
6006-2RSC3	VI	18,71	6020	VI	192,31	6207-ZZC3	VI	26,18	6217-ZZC3	VI	211,26
6006C3	VI	15,12	6020-2RS	VI	237,80	6208	VI	30,12	6218	VI	226,38
6006-ZZ	VI	16,58	6020C3	VI	191,17	6208-2RS	VI	39,18	6218-2RS	VI	293,97
6006-ZZC3	VI	16,76	6020-ZZ	VI	221,15	6208-2RSC3	VI	39,18	6218-2RSC3	VI	292,23
6007	VI	17,86	6021C3	VI	236,15	6208C3	VI	30,44	6218C3	VI	226,38
6007-2RS	VI	23,21	6022C3	VI	283,31	6208-ZZ	VI	34,66	6218-ZZ	VI	260,62
6007-2RSC3	VI	23,21	6024-2RS	VI	415,61	6208-ZZC3	VI	34,66	6219-2RS	VI	386,30
6007C3	VI	18,38	6024C3	VI	330,19	6209	VI	36,85	6219C3	VI	273,29
6007-ZZ	VI	20,55	6200	VI	7,44	6209-2RS	VI	47,83	6219-ZZ	VI	320,10
6007-ZZC3	VI	20,77	6200-2RS	VI	9,69	6209-2RSC3	VI	47,83	6220-2RS	VI	408,19
6008	VI	22,42	6200-2RSC3	VI	9,69	6209C3	VI	37,24	6220C3	VI	314,19
6008-2RS	VI	29,17	6200-ZZ	VI	8,56	6209-ZZ	VI	42,34	6220-ZZ	VI	361,16
6008-2RSC3	VI	29,17	6200-ZZC3	VI	8,56	6209-ZZC3	VI	42,34	6222C3	VI	455,80
6008C3	VI	23,51	6201	VI	7,79	6210	VI	43,60	6224C3	VI	584,66
6008-ZZ	VI	25,81	6201-2RS	VI	10,10	6210-2RS	VI	56,64	6300	VI	10,63
6008-ZZC3	VI	26,08	6201-2RSC3	VI	10,10	6210-2RSC3	VI	56,64	6300-2RS	VI	12,84
6009	VI	29,15	6201C3	VI	8,20	6210C3	VI	43,60	6300-ZZ	VI	11,33
6009-2RS	VI	37,88	6201-ZZ	VI	8,96	6210-ZZ	VI	50,10	6301	VI	10,93
6009-2RSC3	VI	37,88	6201-ZZC3	VI	8,96	6210-ZZC3	VI	50,10	6301-2RS	VI	13,18
6009C3	VI	30,56	6202	VI	8,29	6211	VI	51,49	6301-2RSC3	VI	13,18
6009-ZZ	VI	33,50	6202-2RS	VI	10,88	6211-2RS	VI	66,89	6301-ZZ	VI	11,62

TIMKEN	REM	PRIX HT	TIMKEN	REM	PRIX HT	TIMKEN	REM	PRIX HT	TIMKEN	REM	PRIX HT
6301-ZZC3	VI	11,62	6310-ZZ	VI	88,63	62203-2RS	VI	28,28			
6302	VI	11,00	6310-ZZC3	VI	88,63	62204-2RS	VI	30,98			
6302-2RS	VI	14,26	6311	VI	96,67	62205-2RS	VI	34,15			
6302-2RSC3	VI	14,26	6311-2RS	VI	125,40	62206-2RS	VI	44,01			
6302C3	VI	11,57	6311-2RSC3	VI	125,40	62207-2RS	VI	57,20			
6302-ZZ	VI	12,65	6311C3	VI	96,67	62208-2RS	VI	66,07			
6302-ZZC3	VI	12,65	6311-ZZ	VI	110,92	62209-2RS	VI	88,25			
6303	VI	12,42	6311-ZZC3	VI	110,92	62210-2RS	VI	104,26			
6303-2RS	VI	16,15	6312	VI	122,47	62301-2RS	VI	28,93			
6303-2RSC3	VI	16,15	6312-2RS	VI	159,15	62302-2RS	VI	29,91			
6303C3	VI	13,09	6312-2RSC3	VI	159,15	62303-2RS	VI	33,83			
6303-ZZ	VI	14,28	6312C3	VI	122,47	62304-2RS	VI	39,52			
6303-ZZC3	VI	14,28	6312-ZZ	VI	141,07	62305-2RS	VI	51,57			
6304	VI	14,40	6312-ZZC3	VI	141,07	62306-2RS	VI	71,03			
6304-2RS	VI	18,70	6313	VI	172,46	62307-2RS	VI	88,73			
6304-2RSC3	VI	18,70	6313-2RS	VI	212,97	62308-2RS	VI	114,27			
6304C3	VI	14,62	6313-2RSC3	VI	212,97	63000-2RS	VI	25,27			
6304-ZZ	VI	16,56	6313C3	VI	171,78	63001-2RS	VI	25,22			
6304-ZZC3	VI	16,56	6313-ZZ	VI	195,97	63002-2RS	VI	27,41			
6305	VI	18,12	6313-ZZC3	VI	195,21	63003-2RS	VI	29,31			
6305-2RS	VI	23,55	6314	VI	196,98	63004-2RS	VI	30,94			
6305-2RSC3	VI	23,55	6314-2RS	VI	256,11	63005-2RS	VI	32,53			
6305C3	VI	18,12	6314-2RSC3	VI	259,36	63006-2RS	VI	45,24			
6305-ZZ	VI	20,82	6314C3	VI	199,48	63007-2RS	VI	47,84			
6305-ZZC3	VI	20,82	6314-ZZ	VI	235,36	63008-2RS	VI	55,67			
6306	VI	24,34	6314-ZZC3	VI	234,44						
6306-2RS	VI	31,60	6315	VI	245,52						
6306-2RSC3	VI	31,60	6315-2RS	VI	319,24						
6306-2RSNR	VI	86,25	6315C3	VI	244,58						
6306C3	VI	24,60	6315-ZZ	VI	287,32						
6306-ZZ	VI	28,02	6315-ZZC3	VI	287,32						
6306-ZZC3	VI	28,02	6316	VI	282,91						
6307	VI	32,69	6316-2RS	VI	397,99						
6307-2RS	VI	42,54	6316C3	VI	286,51						
6307-2RSC3	VI	42,54	6316-ZZ	VI	337,93						
6307-2RSNR	VI	74,46	6316-ZZC3	VI	337,93						
6307C3	VI	32,69	6317C3	VI	348,65						
6307-ZZ	VI	37,58	6317-ZZ	VI	414,29						
6307-ZZC3	VI	37,58	6318-2RS	VI	579,36						
6307-ZZNR	VI	48,19	6318C3	VI	423,35						
6308	VI	46,26	6319C3	VI	522,93						
6308-2RS	VI	60,15	6320C3	VI	629,62						
6308-2RSC3	VI	60,15	6322C3	VI	940,18						
6308C3	VI	46,26	6405	VI	72,40						
6308ZC3	VI	60,02	6408	VI	135,99						
6308-ZZ	VI	53,16	6409	VI	166,23						
6308-ZZC3	VI	53,16	6410	VI	195,15						
6309	VI	58,36	16002	VI	14,46						
6309-2RS	VI	75,85	16005	VI	17,20						
6309-2RSC3	VI	75,85	16008	VI	27,02						
6309C3	VI	58,36	16009	VI	37,26						
6309ZC3	VI	75,78	16010	VI	39,75						
6309-ZZ	VI	67,11	16013	VI	71,67						
6309-ZZC3	VI	67,11	16014	VI	87,57						
6310	VI	77,09	16015	VI	97,47						
6310-2RS	VI	100,20	62200-2RS	VI	22,99						
6310-2RSC3	VI	100,20	62201-2RS	VI	23,27						
6310C3	VI	77,09	62202-2RS	VI	25,88						

SUF	EXPLICATIONS
	SANS JOINT
2RS	ÉTANCHE
2RSC3	ÉTANCHE AVEC JEU RADIAL AUGMENTÉ
2RSNR	ÉTANCHE AVEC JONC D'ARRET AVEC GORGE
C3	SANS JOINT AVEC JEU RADIAL AUGMENTÉ
NR	JONC D'ARRET AVEC GORGE
ZC3	AVEC 1 FLASQUE ET JEU RADIAL AUGMENTÉ
ZZ	AVEC FLASQUES
ZZC3	AVEC FLASQUES ET JEU RADIAL AUGMENTÉ
ZZNR	AVEC FLASQUES ET JONC D'ARRET AVEC GORGE



Franco de port messagerie

Le franco est à 2000 € disques de frein BREMBO

Pour les autres produits le franco de port est à 800 €

Dans le cas de commande mixte (50% à 800 € et 50% à 2000 €) le franco sera à 1400 €

Bien entendu ce franco de port mixte sera négocié dans le cas où nous avons une faible quantité de disques de frein BREMBO.

Coût de transport :

Afin d'améliorer votre efficacité et rentabilité commerciale

Désormais 4 niveaux services vous sont proposés :

Express (J+1 le matin) jusqu'à 30 Kg
Express (J+1 le matin) de 30 Kg à 700 kg
Messagerie Rapide (J+1)
la Messagerie (J+2)

Les coûts de transport sont communiqués sur demande.



CONDITIONS GÉNÉRALES DE VENTE DE GIL AUTOMOTIVE

Toute commande emporte adhésion de plein droit et sans réserve à nos Conditions Générales de Vente, nonobstant toute stipulation contraire figurant dans les conditions générales d'achat du client.

Toute condition contraire posée par le client sera inopposable à GIL AUTOMOTIVE, à défaut d'acceptation expresse et écrite de celle-ci, quel que soit le moment où elle aura été portée à sa connaissance.

Clause n° 1 : Objet

Les conditions générales de ventes décrites ci-après détaillent les droits et obligations de la société GIL Automotive et de son client dans le cadre de la vente des marchandises suivantes :

Pièces détachées Automobiles et Poids Lourds

Toute prestation accomplie par la société GIL Automotive implique donc l'adhésion sans réserve de l'acheteur aux présentes conditions générales de vente.

Clause n° 2 : Prix

Les prix des marchandises vendues sont ceux en vigueur au jour de la prise de commande.

Ils sont libellés en euros et calculés hors taxes.

Par voie de conséquence, ils seront majorés du taux de TVA et des frais de transport applicables au jour de la commande.

La société GIL Automotive s'accorde le droit de modifier ses tarifs à tout moment.

Toutefois, elle s'engage à facturer les marchandises commandées aux prix indiqués lors de l'enregistrement de la commande.

Clause n° 3 : Rabais et ristournes

Les tarifs proposés comprennent les rabais et ristournes que la société GIL Automotive serait amenée à octroyer compte tenu de ses résultats ou de la prise en charge par l'acheteur de certaines prestations.

Clause n° 4 : Escompte

Aucun escompte ne sera consenti en cas de paiement anticipé.

Clause n° 5 : Modalités de paiement

Le règlement des commandes s'effectue :

- soit par chèque ;
- soit par virement bancaire.

Lors de l'enregistrement de la commande, l'acheteur devra verser un acompte de 10% du montant global de la facture, le solde devant être payé à réception des marchandises.

Clause n° 6 : Retard de paiement

En cas de défaut de paiement total ou partiel des marchandises livrées au jour de la réception, l'acheteur doit verser à la société GIL Automotive une pénalité de retard égale à une fois et demi le taux de l'intérêt légal.

Le taux de l'intérêt légal retenu est celui en vigueur au jour de la livraison des marchandises.

Cette pénalité est calculée sur le montant hors taxes de la somme restant due, et court à compter de la date d'échéance du prix sans qu'aucune mise en demeure préalable ne soit nécessaire.

Clause n° 7 : Clause résolutoire

Si dans les quinze jours qui suivent la mise en oeuvre de la clause « Retard de paiement », l'acheteur ne s'est pas acquitté des sommes restant dues, la vente sera résolue de plein droit et pourra ouvrir droit à l'allocation de dommages et intérêts au profit de la société GIL Automotive.

Clause n° 8 : Réserve de propriété

La société GIL Automotive conserve la propriété des biens vendus jusqu'au paiement intégral du prix, en principal et en accessoires.

À ce titre, si l'acheteur fait l'objet d'un redressement ou d'une liquidation judiciaire, la société GIL Automotive se réserve le droit de revendiquer, dans le cadre de la procédure collective, les marchandises vendues et restées impayées.

Clause n° 9 : Livraison

La livraison est effectuée :

- soit par la remise directe de la marchandise à l'acheteur ;
- soit par l'envoi d'un avis de mise à disposition en magasin à l'attention de l'acheteur ;
- soit au lieu indiqué par l'acheteur sur le bon de commande.

Le délai de livraison indiqué lors de l'enregistrement de la commande n'est donné qu'à titre indicatif et n'est aucunement garanti.

Par voie de conséquence, tout retard raisonnable dans la livraison des produits ne pourra pas donner lieu au profit de l'acheteur à :

- l'allocation de dommages et intérêts ;
- l'annulation de la commande.

Le risque et péril du transport est supporté en totalité par l'acheteur.

En cas de marchandises manquantes ou détériorées lors du transport, l'acheteur devra formuler toutes les réserves nécessaires sur le bon de commande à réception desdites marchandises. Ces réserves devront être, en outre, confirmées par écrit dans les cinq jours suivant la livraison, par courrier recommandé AR.

Clause n° 10 : Force majeure

La responsabilité de la société GIL Automotive ne pourra pas être mise en oeuvre si la non-exécution ou le retard dans l'exécution de l'une de ses obligations décrites dans les présentes conditions générales de vente découle d'un cas de force majeure.

À ce titre, la force majeure s'entend de tout événement extérieur, imprévisible et irrésistible au sens de l'article 1148 du Code civil.

Clause n° 11 : Tribunal compétent

Tout litige relatif à l'interprétation et à l'exécution des présentes conditions générales de vente est soumis au droit français.