

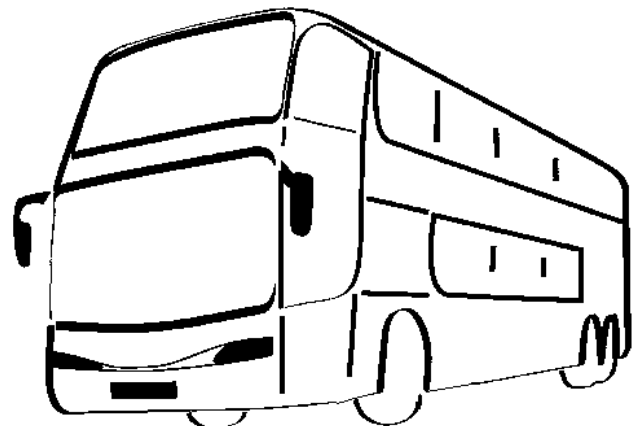

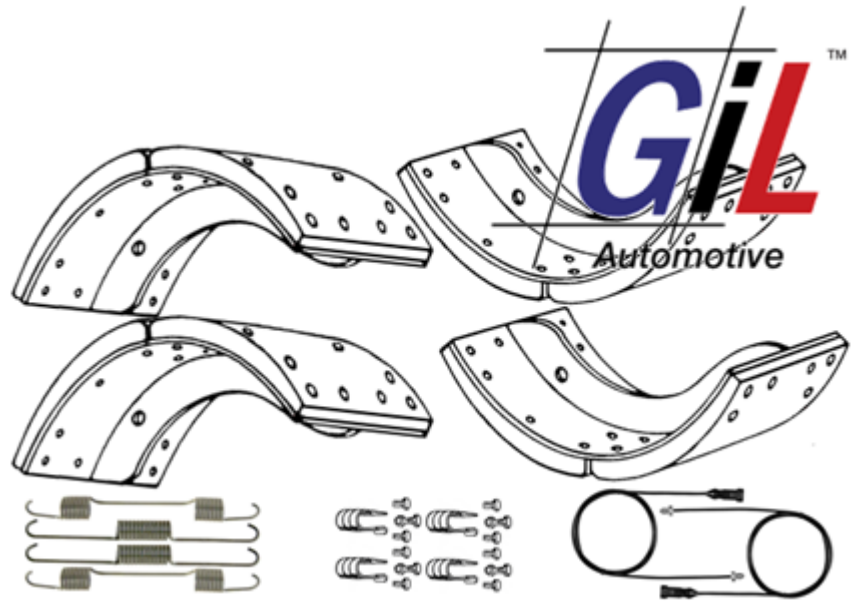

CATALOGUE PIÈCES DE FRICTIONS A
TAMBOURS POIDS LOURDS
MÂCHOIRES DE FREIN GARNIES ET KIT DE
GARNITURES AVEC ACCESSOIRES

CV FRICTIONS DRUM PART CATALOGUE
CV LINED BRAKE SHOES AND CV LINING KIT
WITH FITTING KIT

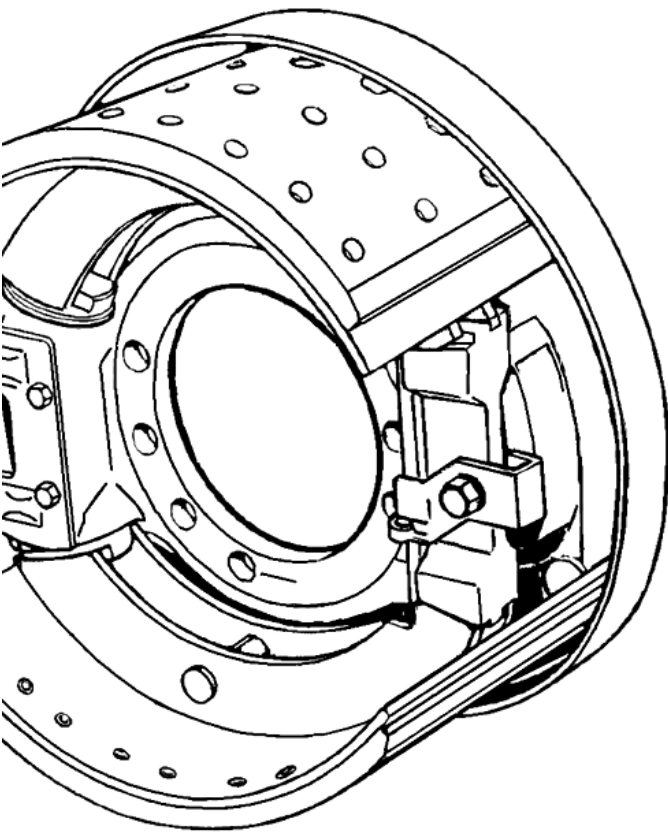



CATALOGUE PIECES DE FRICTIONS A
TAMBOURS POIDS LOURDS
MÂCHOIRES DE FREIN GARNIES ET KIT DE
GARNITURES AVEC ACCESSOIRES
CV FRICTIONS DRUM PART CATALOGUE
CV LINED BRAKE SHOES AND CV LINING KIT
WITH FITTING KIT

	PAGE
 SOMMAIRE	2
INTRODUCTION - NOUVEAUTES	3-4
ABREVIATIONS - EXPLICATIONS DES REFERENCES	5
TUTORIEL D'UTILISATION DU CATALOGUE	6
APPLICATION PAR VEHICULES	7-16
PIECES DE FREINAGE POUR GRUES MOBILES	17-18
RECHERCHE GARNITURES PAR DIMENSIONS	19-32
DIMENSIONS DES RIVETS	33
LISTE APPLICATIVE DES TEMOINS D'USURE	34-36
KIT COMPLET MACHOIRES GARNIES+ACCESSOIRES	37-54
ILLUSTRATIONS	55-71
CORRESPONDANCE DES REFERENCES	72-117
TRADUCTION	118-122
AVIS DE NON-RESPONSABILITE	123
 CONTENTS	2
INTRODUCTION - NEWS	3-4
ABBREVIATION - PART NUMBERS EXPLANATION	5
HOW TO USE THE CATALOG	6
APPLICATION BY VEHICLE	7-16
BRAKE PARTS FOR MOBILE CRANES	17-18
BRAKE LINING RESEARCH BY SIZE	19-32
RIVETS DIMENSIONS	33
WEAR INDICATORS LIST	34-36
COMPLETE BRAKE SHOES KIT + FITTING KIT	37-54
DRAWINGS	55-71
CROSS REFERENCES LIST	72-117
TRANSLATION	118-122
DISCLAIMER	123

INTRODUCTION

Ce catalogue est complémentaire aux catalogues existants de Textar (<http://www.gil-automotive.com/archives/textarcvcatalogue.pdf> ou sur www.brakebook.com). La recherche par véhicule est simplifiée et représente 95% des ventes. La recherche des garnitures par dimensions inclut 99.5% des freins à tambours Européens existants (les garnitures avec terminaison xx sont sur demande et livrable sous 48 à 72 heures). Vous trouverez dans ILLUSTRATIONS les pièces complémentaires pour réaliser les opérations de maintenance des freins les plus importants ; ceux-ci se retrouvent en effectuant une recherche par les 5 chiffres du WVA ou des 5 premiers chiffres de la référence Textar.

 This catalog is complementary to existing Textar catalogs (<http://www.gil-automotive.com/archives/textarcvcatalogue.pdf> or www.brakebook.com). Search by vehicle is simplified and represents 95% of sales. Search by linings dimensions includes 99.5% of the existing European drum brake (trim xx termination are available on demand and within 48 to 72 hours). Into DRAWINGS section you will find the additional parts to achieve the maintenance of the biggest brakes; they can be found by searching by the 5 digits of the WVA or first 5 digits of Textar reference.

Nouveautés /News

Nous avons beaucoup travaillé les kits de mâchoires garnies et actionneurs ou kit de réparation actionneurs. Vous retrouverez dans la partie applicative et dans les planches représentatives par type de frein. Ces planches sont composées en ensemble **FRICTION (1)** et **ACTION (2)**

We have worked a lot on lined brake shoes kits and actuators or actuator repair kits. You will find in the application part and in representative boards by type of brake. These boards are composed in **FRICTION (1)** and **ACTION (2)** sets.

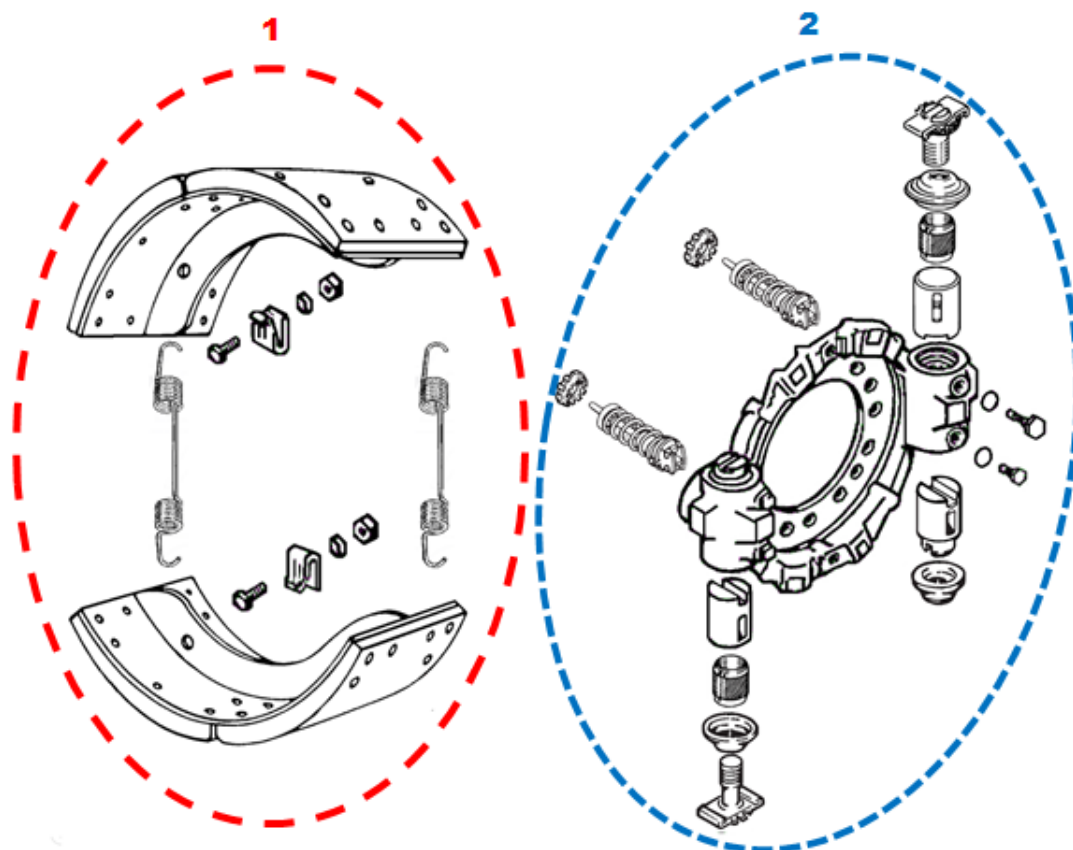

Nouveautés /News ..!..

FRICION (1)

Vous trouverez dans ce catalogue pour les montages les plus courants des kits de mâchoires garnies avec et sans accessoires. Vous pourrez également acheter les accessoires séparément comme indiqué dans le schéma ci-dessous:

You will find in this catalog for the most common lined brake shoes kits with and without fitting kits. You will also be able to purchase the fitting kits separately as shown in the diagram below:

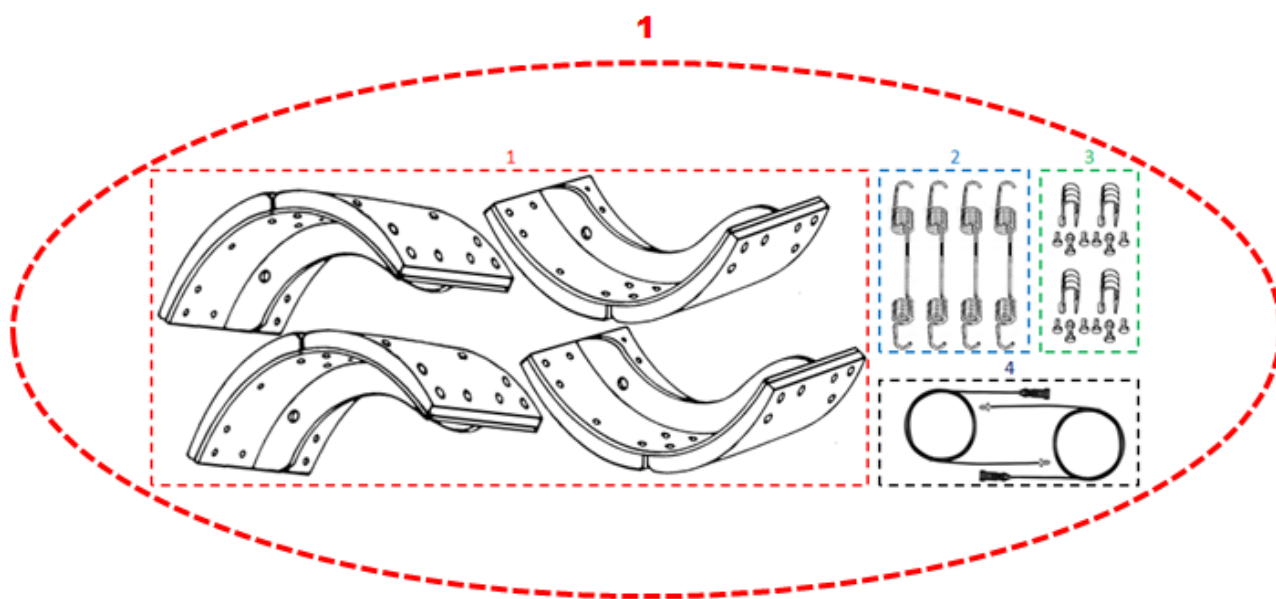

ACTION (2)

Vous trouverez dans ce catalogue pour les montages les plus courants des kits de réparation pour actionneurs ou l'actionneur complet. Vous pourrez également acheter chaque composant séparément comme indiqué dans le schéma ci-dessous:

You will find in this catalogue the most common actuators repair kits assemblies or the complete actuators. You will also be able to purchase each component separately as shown in the diagram below:

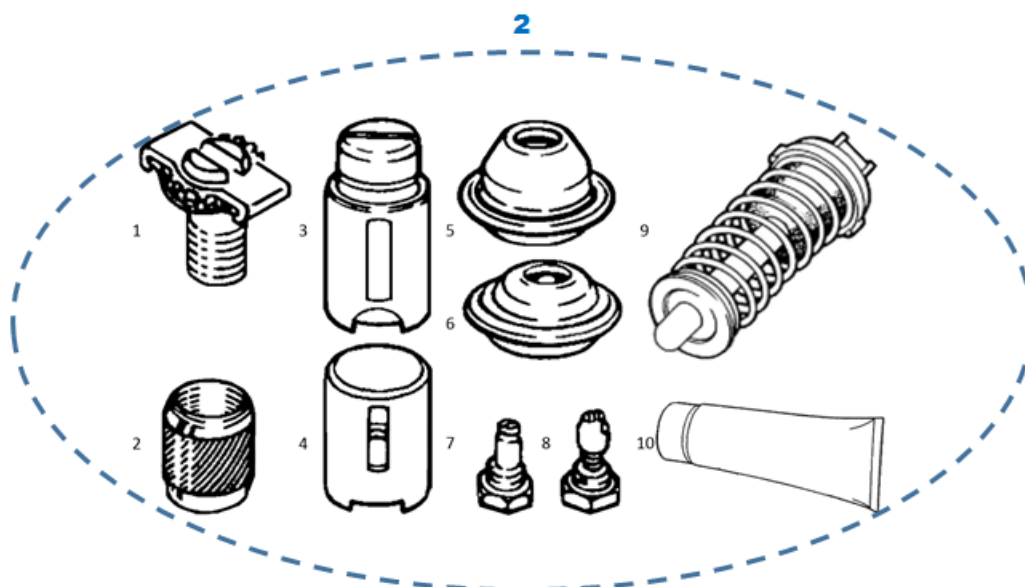











CATALOGUE PIÈCES DE FRICTIONS A
 TAMBOURS POIDS LOURDS
 MÂCHOIRES DE FREIN GARNIES ET KIT DE
 GARNITURES AVEC ACCESSOIRES
 CV FRICTIONS DRUM PART CATALOGUE
 CV LINED BRAKE SHOES AND CV LINING KIT
 WITH FITTING KIT

ABREVIATIONS	Français	English
410x200	Ø Tambour x Largeur Garniture	Drum Ø x Lining width
AV	Essieu avant	Front axle
AV/AR	Essieu avant & arrière	Front and rear axle
AR	Essieu arrière	Rear axle
SIMPLEX	1 Actionneur	1 Actuator
DUPLEX	2 Actionneurs	2 Actuators
RPP	Remplacé par	Superseded
EXPLICATIONS DES REFERENCES / PARTNUMBERS EXPLANATION		
MACxxxxx	Mâchoire nue	Unlined brake shoe
MACxxxxxCAST	Mâchoire nue en fonte	Cast Unlined brake shoe
MACxxxxx/2	Mâchoires nues en kit de 2 pièces	Unlined brake shoes kit 2 pieces

 Après ouverture du catalogue, veuillez taper les touches de votre clavier (**Ctrl+F**), une case va s'ouvrir (en vert) taper par exemple KERAX, appuyer sur entrée, vous remarquerez que vous arrivez sur les applications pour KERAX, appuyer sur entrée vous irez aux étriers pour le KERAX et vous continuez cette procédure afin de trouver le restant des pièces pour le KERAX. Vous pouvez également effectuer une recherche d'un numéro OES exemple: Veuillez taper les touches de votre clavier (**Ctrl+F**), écrivez 5001825627 puis entrée vous arriverez directement à la référence 1925501 Après avoir trouvé la référence 1925501, vous pouvez la copier en la surbrillant puis (**Ctrl+C**) et téléchargez le tarif général puis (**Ctrl+F**) et (**Ctrl+V**) pour coller, puis entrée, vous trouverez alors le prix et le code de remise du produit dans ce cas c'est 6.

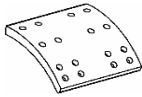

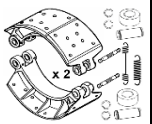



 After opening the catalog, please type the keys on your keyboard (**Ctrl + F**), a pop up will be open (green) eg type KERAX, press enter, you will notice that you get the master cylinder KERAX, press on entry then go to the caliper application for KERAX and you continue this process to find the remaining parts for KERAX. You can also search an OES number example: Please type in your keyboard (**Ctrl + F**), then write 5001825627 entry you come to the partnumber 1925501 After finding the part number 1925501, you can copy it on the brilliant and (**Ctrl + C**) and then download list price (**Ctrl + F**) and (**Ctrl + V**) to paste and input, you then find the price and the product discount code in this case is 6.

APPLICATION PAR VEHICULES APPLICATION BY VEHICLES

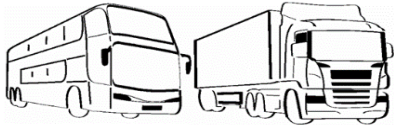
									
BPW									
AGRICOLE		310x80	55173		55173001517	RIV615T11			
H & EH >1995 SN4218.1 - 22,5"		420x180 CO +0 mm	19032		1903230	RIV815		1903270	
ECO 95 SN4218.2 - 22,5"		420x180 CO +0 mm	19032		1903230	RIV815		1903271	
H & EH >1995 SN4220.1 - 22,5"		420x200 CO +0 mm	19094		1909437	RIV815		1909470	
ECO 95 SN4220.2 - 22,5"		420x200 CO +0 mm	19094		1909437	RIV815		1909471	
COLAERT									
ADR FAD BRAKE 310S		300x100 AGRICOLE	57251		57251001561	RIV812			
ADR FAD BRAKE 314S		300x135 AGRICOLE	57248		57248001561	RIV812			
ADR FAD BRAKE 314E		300x135 AGRICOLE	57250		57250001561	RIV812			
ADR FAD		300x150 AGRICOLE	59338		59338001561	RIV815			
ADR FAD 316-PA		300x160 AGRICOLE	59335		59335001561	RIV815			
ADR FAD 406A, 406E, 412S		406X120 AGRICOLE	17016		17016301561	RIV812			
DAF									
1900	AV	420x150 DAF	19010/19011		1901005	RIV6.517			
2300	AV	420x150 DAF	19010/19011		1901005	RIV6.517			
2300	AR	420x200 DAF	19063/19064		1906303	RIV6.517	MAC9063/64	1906380	
2500	AV	420x150 DAF	19010/19011		1901005	RIV6.517			
2700	AV	420x150 DAF	19010/19011		1901005	RIV6.517			
2700	AR	420x200 DAF	19063/19064		1906303	RIV6.517	MAC9063/64	1906380	
2900	AV	420x150 DAF	19010/19011		1901005	RIV6.517			
2900	AR	420x200 DAF	19063/19064		1906303	RIV6.517	MAC9063/64	1906380	
50 F	AV/AR	360x170 PERROT	19503		1950308	RIV816	MAC9503	1950380	KTU010
55 F	AR	360x170 PERROT	19503		1950308	RIV816	MAC9503	1950380	KTU010
65 F	AV	420x150 DAF	19010/19011		1901005	RIV6.517			
65 F	AR	420x200 DAF	19063/19064		1906303	RIV6.517	MAC9063/64	1906380	
75 F	AV	420x150 DAF	19010/19011		1901005	RIV6.517			
75 F	AR	420x150 DAF	19010/19011		1901005	RIV6.517			
75 F	AR	420x200 DAF	19063/19064		1906303	RIV6.517	MAC9063/64	1906380	
85 F	AV	420x150 DAF	19010/19011		1901005	RIV6.517			
85 F	AR	420x150 DAF	19010/19011		1901005	RIV6.517			

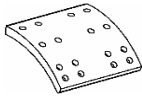

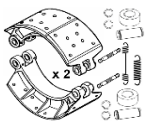





* Kit mâchoires garnies sans accessoires / Lined brake shoes kit without fitting kit

APPLICATION PAR VEHICULES APPLICATION BY VEHICLES

			WVA					
DAF ../.								
85 F	AR	420x200 DAF	19063/19064	1906303	RIV6.517	MAC9063/64	1906380	
95 F	AV	420x150 DAF	19010/19011	1901005	RIV6.517			
95 F	AV	420x200 DAF	19063/19064	1906303	RIV6.517	MAC9063/64	1906380	
95 F	AR	420x150 DAF	19010/19011	1901005	RIV6.517			
95 F	AR	420x200 DAF	19063/19064	1906303	RIV6.517	MAC9063/64	1906380	
105 XF	AR	410x200 MERITOR	19071	1907102	RIVL11	MAC9071/2	1907180	
E - SERIE	AV	410x175 MERITOR	19090	1909002	RIVL11	MAC9090/2	1909080	
E - SERIE	AR	410x200 MERITOR	19071	1907102	RIVL11	MAC9071/2	1907180	
GIGANT								
GKHI 10510-3020		300x200 CO +0 mm	19574	1957431	RIV815		1957471	
IRISBUS								
AGORA	AR	414x220 RT	19187	1918702	RIV818	MAC9187	1918780	
E - SERIE	AR	414x150 BENDIX	19049/19199	1904902	RIV615T11	MAC9049/199		
FR 1	AR	414x175 RT	19935	1993502	RIV818	MAC9935	1993580	
FR 1	AR	414x200 RT	19974	19974xx	RIV818	MAC9974		
FR 1	AR	414x220 RT	19187	1918702	RIV818	MAC9187	1918780	
HEULIEZ	AV	414x150 BENDIX	19049/19199	1904902	RIV615T11	MAC9049/199		
HEULIEZ	AV/AR	414x175 RT	19935	1993502	RIV818	MAC9935	1993580	
HEULIEZ	AR	414x220 RT	19187	1918702	RIV818	MAC9187	1918780	
HEULIEZ	AR	410x225 MERITOR	19068	1906802	RIVL10	MAC9068/2	1906880	
ILIADE	AR	414x220 RT	19187	1918702	RIV818	MAC9187	1918780	
PR	AV/AR	414x150 BENDIX	19049/19199	1904902	RIV615T11	MAC9049/199		
PR	AV	414x175 RT	19935	1993502	RIV818	MAC9935	1993580	
PR	AR	414x200 RT	19974	19974xx	RIV818	MAC9974		
RECREO 2	AR	410x200 MERITOR	19071	1907102	RIVL11	MAC9071/2	1907180	
S - SERIE	AV/AR	414x150 BENDIX	19049/19199	1904902	RIV615T11	MAC9049/199		
TRACER	AV/AR	414x175 RT	19935	1993502	RIV818	MAC9935	1993580	
IVECO								
EUROCARGO	AR	360x170 PERROT	19503	1950308	RIV816	MAC9503	1950380	KTU010
EUROCARGO	AR	360x170 MERITOR	19503	1950308	RIV816	MAC9503M	1950380M	KTU013

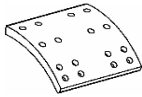

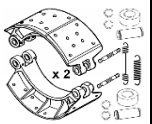



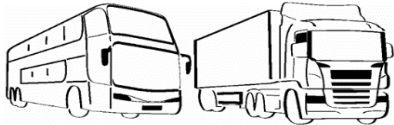

* Kit mâchoires garnies sans accessoires / Lined brake shoes kit without fitting kit

APPLICATION PAR VEHICULES APPLICATION BY VEHICLES

								
IVECO .../.								
EUROCARGO	AV/AR	381x178 MERITOR	19384/19385	1938414	RIV10-10			KTU012
EUROSTAR	AR	410x182 PERROT 2	19099/19100	1909902	RIV816	MAC9099	1909980	98032100
EUROSTAR SIMPLEX -04.96	AR	410x180 ROCKWELL	19555/19556	1955502	RIV815			98032200
EUROSTAR SIMPLEX 05.96-05.03	AR	410x180 ROCKWELL	19714/19715/19556	1971401	RIV815		1971480	98032200
EUROSTAR DUPLEX 06.03-04.17	AR	410x180 ROCKWELL	19109/19110	1910902	RIV816		1910980	KTU011
EUROSTAR DUPLEX 05.17-	AR	410x180 ROCKWELL	19109/19110	1910902	RIV816		1910980NV	KTU011
EUROSTAR	AR	410x200 PERROT 1	19343/19263 RPP	1909102	RIV816	MAC9091/98	1909180	98032100
EUROSTAR	AR	410x202 PERROT 2	19091/19098	1909102	RIV816	MAC9091/98	1909180	98032100
EUROSTAR SIMPLEX -04.96	AR	410x200 ROCKWELL	19554/19553	1955301	RIV815			98032200
EUROSTAR SIMPLEX 05.96-05.03	AR	410x200 ROCKWELL	19716/19717/19553	1971612	RIV815		1971680	98032200
EUROSTAR DUPLEX 06.03-04.17	AR	410x200 ROCKWELL	19116/19119	1911602	RIV815		1911680	KTU011
EUROSTAR DUPLEX 05.17-	AR	410x200 ROCKWELL	19116/19119	1911602	RIV815		1911680NV	KTU011
EUROTECH	AR	410x202 PERROT 2	19091/19098	1909102	RIV816	MAC9091/98	1909180	98032100
EUROTECH	AR	410x182 PERROT 2	19099/19100	1909902	RIV816	MAC9099	1909980	98032100
EUROTECH MP SIMPLEX -04.96	AR	410x180 ROCKWELL	19555/19556	1955502	RIV815			98032200
EUROTECH MP SIMPLEX 05.96-05.03	AR	410x180 ROCKWELL	19714/19715/19556	1971401	RIV815		1971480	98032200
EUROTECH MP DUPLEX 06.03-04.17	AR	410x180 ROCKWELL	19109/19110	1910902	RIV816		1910980	KTU011
EUROTECH MP DUPLEX 05.17-	AR	410x180 ROCKWELL	19109/19110	1910902	RIV816		1910980NV	KTU011
EUROTECH MP SIMPLEX -04.96	AR	410x200 ROCKWELL	19554/19553	1955301	RIV815			98032200
EUROTECH MP SIMPLEX 05.96-05.03	AR	410x200 ROCKWELL	19716/19717/19553	1971612	RIV815		1971680	98032200
EUROTECH MP DUPLEX 06.03-04.17	AR	410x200 ROCKWELL	19116/19119	1911602	RIV815		1911680	KTU011
EUROTECH MP DUPLEX 05.17-	AR	410x200 ROCKWELL	19116/19119	1911602	RIV815		1911680NV	KTU011
EUROTECH MP	AR	410x180 PERROT 1	19342/19262 RPP	1909902	RIV816	MAC9099	1909980	98032100
EUROTECH MP	AR	410x182 PERROT 2	19099/19100	1909902	RIV816	MAC9099	1909980	98032100
EUROTECH MP	AR	410x200 PERROT 1	19343/19263 RPP	1909102	RIV816	MAC9091/98	1909180	98032100
EUROTECH MP	AR	410x202 PERROT 2	19091/19098	1909102	RIV816	MAC9091/98	1909180	98032100
EUROTECH MT SIMPLEX -04.96	AR	410x180 ROCKWELL	19555/19556	1955502	RIV815			98032200
EUROTECH MT SIMPLEX 05.96-05.03	AR	410x180 ROCKWELL	19714/19715/19556	1971401	RIV815		1971480	98032200
EUROTECH MT DUPLEX 06.03-04.17	AR	410x180 ROCKWELL	19109/19110	1910902	RIV816		1910980	KTU011
EUROTECH MT DUPLEX 05.17-	AR	410x180 ROCKWELL	19109/19110	1910902	RIV816		1910980NV	KTU011

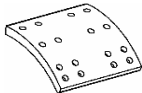

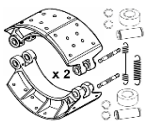



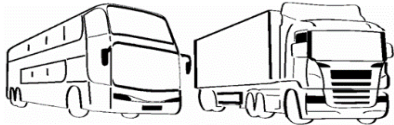

* Kit mâchoires garnies sans accessoires / Lined brake shoes kit without fitting kit

APPLICATION PAR VEHICULES APPLICATION BY VEHICLES

								
IVECO ../..								
EUROTECH MT SIMPLEX -04.96	AR	410x200 ROCKWELL	19554/19553	1955301	RIV815			98032200
EUROTECH MT SIMPLEX 05.96-05.03	AR	410x200 ROCKWELL	19716/19717/19553	1971612	RIV815		1971680	98032200
EUROTECH MT DUPLEX 06.03-04.17	AR	410x200 ROCKWELL	19116/19119	1911602	RIV815		1911680	KTU011
EUROTECH MT DUPLEX 05.17-	AR	410x200 ROCKWELL	19116/19119	1911602	RIV815		1911680NV	KTU011
EUROTRAKKER	AV	410x200 PERROT 1	19343/19263 RPP	1909102	RIV816	MAC9091/98	1909180	98032100
EUROTRAKKER	AV	410x202 PERROT 2	19091/19098	1909102	RIV816	MAC9091/98	1909180	98032100
EUROTRAKKER SIMPLEX -04.96	AV	410x200 ROCKWELL	19554/19553	1955301	RIV815			98032200
EUROTRAKKER SIMPLEX 05.96-05.03	AV	410x200 ROCKWELL	19716/19717/19553	1971612	RIV815		1971680	98032200
EUROTRAKKER DUPLEX 06.03-04.17	AV	410x200 ROCKWELL	19116/19119	1911602	RIV815		1911680	KTU011
EUROTRAKKER DUPLEX 05.17-	AV	410x200 ROCKWELL	19116/19119	1911602	RIV815		1911680NV	KTU011
EUROTRAKKER	AR	410x200 PERROT 1	19343/19263 RPP	1909102	RIV816	MAC9091/98	1909180	98032100
EUROTRAKKER	AR	410x202 PERROT 2	19091/19098	1909102	RIV816	MAC9091/98	1909180	98032100
EUROTRAKKER SIMPLEX -04.96	AR	410x200 ROCKWELL	19554/19553	1955301	RIV815			98032200
EUROTRAKKER SIMPLEX 05.96-05.03	AR	410x200 ROCKWELL	19716/19717/19553	1971612	RIV815		1971680	98032200
EUROTRAKKER DUPLEX 06.03-04.17	AR	410x200 ROCKWELL	19116/19119	1911602	RIV815		1911680	KTU011
EUROTRAKKER DUPLEX 05.17-	AR	410x200 ROCKWELL	19116/19119	1911602	RIV815		1911680NV	KTU011
MAN								
EL-Series	AR	410x220 MERCEDES	19496	1949602	RIV818	MAC9496CAST	1949678*	98023500
F2000	AV	410x180 MERCEDES	19495	1949502	RIV818	MAC9495CAST	1949578*	98023500
F2000	AR	410x180 MERCEDES	19495	1949502	RIV818	MAC9495CAST	1949578*	98023500
F2000	AR	410x220 MERCEDES	19496	1949602	RIV818	MAC9496CAST	1949678*	98023500
F90	AV	410x160 MERCEDES	19494	1949402	RIV815			98023500
F90	AV	410x180 MERCEDES	19495	1949502	RIV818	MAC9495CAST	1949578*	98023500
F90	AR	410x220 MERCEDES	19496	1949602	RIV818	MAC9496CAST	1949678*	98023500
FR/FRH-Series	AV	410x160 MERCEDES	19494	1949402	RIV815			98023500
FR/FRH-Series	AR	410x220 MERCEDES	19496	1949602	RIV818	MAC9496CAST	1949678*	98023500
M2000	AV	410x160 MERCEDES	19494	1949402	RIV815			98023500
M2000	AR	410x180 MERCEDES	19495	1949502	RIV818	MAC9495CAST	1949578*	98023500
M2000	AR	410x220 MERCEDES	19496	1949602	RIV818	MAC9496CAST	1949678*	98023500
NG-Series	AV	410x160 MERCEDES	19494	1949402	RIV815			98023500

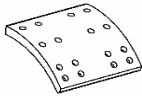

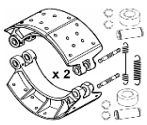



* Kit mâchoires garnies sans accessoires / Lined brake shoes kit without fitting kit

APPLICATION PAR VEHICULES APPLICATION BY VEHICLES

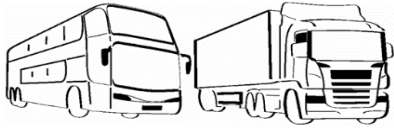
									
MAN ..J..									
NG-Series	AR	410x220	MERCEDES 19496	1949602	RIV818	MAC9496CAST	1949678*	98023500	
NL-Series	AV	410x160	MERCEDES 19494	1949402	RIV815			98023500	
NL-Series	AR	410x220	MERCEDES 19496	1949602	RIV818	MAC9496CAST	1949678*	98023500	
SD/SL-Series	AV	410x160	MERCEDES 19494	1949402	RIV815			98023500	
SD/SL-Series	AR	410x220	MERCEDES 19496	1949602	RIV818	MAC9496CAST	1949678*	98023500	
SG-Series	AV	410x160	MERCEDES 19494	1949402	RIV815			98023500	
SG-Series	AR	410x160	MERCEDES 19494	1949402	RIV815			98023500	
SG-Series	AR	410x180	MERCEDES 19495	1949502	RIV818	MAC9495CAST	1949578*	98023500	
SG-Series	AR	410x220	MERCEDES 19496	1949602	RIV818	MAC9496CAST	1949678*	98023500	
SR-Series	AV	410x160	MERCEDES 19494	1949402	RIV815			98023500	
SR-Series	AR	410x220	MERCEDES 19496	1949602	RIV818	MAC9496CAST	1949678*	98023500	
SÜ-Series	AV	410x160	MERCEDES 19494	1949402	RIV815			98023500	
SÜ-Series	AR	410x220	MERCEDES 19496	1949602	RIV818	MAC9496CAST	1949678*	98023500	
TGA	AR	410x220	MERCEDES 19496	1949602	RIV818	MAC9496CAST	1949678*	98023500	
ÜL-Series	AV	410x160	MERCEDES 19494	1949402	RIV815			98023500	
ÜL-Series	AR	410x220	MERCEDES 19496	1949602	RIV818	MAC9496CAST	1949678*	98023500	
MERCEDES									
Actros	AV	410x180	MERCEDES 19495	1949502	RIV818	MAC9495CAST	1949578*	98017002	
Actros	AR	410x220	MERCEDES 19496	1949602	RIV818	MAC9496CAST	1949678*	98017002	
Atego	AV	410x180	MERCEDES 19495	1949502	RIV818	MAC9495CAST	1949578*	98017002	
Atego	AR	410x220	MERCEDES 19496	1949602	RIV818	MAC9496CAST	1949678*	98017002	
LK-Series	AV	410x160	MERCEDES 19494	1949402	RIV815			98017002	
LK-Series	AR	410x160	MERCEDES 19494	1949402	RIV815			98017002	
MS/SK-Series	AV	410x160	MERCEDES 19494	1949402	RIV815			98017002	
MS/SK-Series	AV	410x180	MERCEDES 19495	1949502	RIV818	MAC9495CAST	1949578*	98017002	
MS/SK-Series	AR	410x160	MERCEDES 19494	1949402	RIV815			98017002	
MS/SK-Series	AR	410x180	MERCEDES 19495	1949502	RIV818	MAC9495CAST	1949578*	98017002	
MS/SK-Series	AR	410x220	MERCEDES 19496	1949602	RIV818	MAC9496CAST	1949678*	98017002	
OLD RANGE 33t	AR	410x220	MERCEDES 19496	1949602	RIV818	MAC9496CAST	1949678*	98017002	
O-Series	AV	410x160	MERCEDES 19494	1949402	RIV815			98017002	

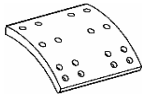

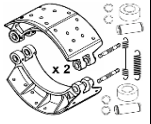





* Kit mâchoires garnies sans accessoires / Lined brake shoes kit without fitting kit

APPLICATION PAR VEHICULES APPLICATION BY VEHICLES

			WVA					
MERCEDES ../.								
O-Series	AV	410x180	MERCEDES 19495	1949502	RIV818	MAC9495CAST	1949578*	98017002
O-Series	AR	410x180	MERCEDES 19495	1949502	RIV818	MAC9495CAST	1949578*	98017002
O-Series	AR	410x220	MERCEDES 19496	1949602	RIV818	MAC9496CAST	1949678*	98017002
RENAULT Trucks								
BERLIET	AV/AR	414x150	BENDIX 19049/19199	1904902	RIV615T11	MAC9049/199		
C - RANGE	AV	414x150	BENDIX 19049/19199	1904902	RIV615T11	MAC9049/199		
C - RANGE	AV	414x150	RT 19934	1993402	RIV818	MAC9934	1993480	
C - RANGE	AV	414x175	RT 19935	1993502	RIV818	MAC9935	1993580	
C - RANGE	AR	414x150	BENDIX 19049/19199	1904902	RIV615T11	MAC9049/199		
C - RANGE	AR	414x150	RT 19934	1993402	RIV818	MAC9934	1993480	
C - RANGE	AR	414x175	RT 19935	1993502	RIV818	MAC9935	1993580	
G - MANAGER	AV	414x150	BENDIX 19049/19199	1904902	RIV615T11	MAC9049/199		
G - MANAGER	AV	414x150	RT 19934	1993402	RIV818	MAC9934	1993480	
G - MANAGER	AV	414x175	RT 19935	1993502	RIV818	MAC9935	1993580	
G - MANAGER	AR	414x175	RT 19935	1993502	RIV818	MAC9935	1993580	
G - MANAGER	AR	414x150	RT 19934	1993402	RIV818	MAC9934	1993480	
G - MAXTER	AV/AR	414x175	RT 19935	1993502	RIV818	MAC9935	1993580	
KERAX	AV	414x175	RT 19935	1993502	RIV818	MAC9935K	1993580K	
KERAX	AR	414x175	RT 19935	1993502	RIV818	MAC9935K	1993580K	
KERAX	AR	414x220	RT 19187	1918702	RIV818	MAC9187K	1918780K	
KERAX Dxi 10.05-01.13	AV	410x175	MERITOR 19090	1909002	RIVL11	MAC9090/2	1909080	
KERAX Dxi 10.05-01.13	AR	410x200	MERITOR 19071	1907102	RIVL11	MAC9071/2	1907180	
KERAX Dxi 10.05-01.13	AR	410x225	MERITOR 19068	1906802	RIVL10	MAC9068/2	1906880	
K-SERIE 01.13-	AV	410x175	MERITOR 19090	1909002	RIVL11	MAC9090/2	1909080	
K-SERIE 01.13-	AR	410x200	MERITOR 19071	1907102	RIVL11	MAC9071/2	1907180	
K-SERIE 01.13-	AR	410x225	MERITOR 19068	1906802	RIVL10	MAC9068/2	1906880	
MAGNUM AE	AR	414x150	RT 19934	1993402	RIV818	MAC9934	1993480	
MAGNUM AE	AR	414x175	RT 19935	1993502	RIV818	MAC9935	1993580	
MAGNUM AE	AR	414x220	RT 19187	1918702	RIV818	MAC9187	1918780	
MIDLINER M/S	AV	414x150	RT 19934	1993402	RIV818	MAC9934	1993480	

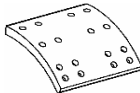

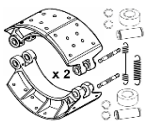



* Kit mâchoires garnies sans accessoires / Lined brake shoes kit without fitting kit

APPLICATION PAR VEHICULES APPLICATION BY VEHICLES

								
RENAULT Trucks ../.								
MIDLINER M/S	AR	310x125 BENDIX	17352	17352xx	RIV512	AB350929		
MIDLINER M/S	AR	325x150 BENDIX	19709	19709003658	RIV512	AB350891		
MIDLINER M/S	AR	360x170 BENDIX	19255/19259	1925501	RIV512	AB337220	1925580	
MIDLINER M/S	AR	414x150 BENDIX	19049/19199	1904902	RIV615T11	MAC9049/199		
MIDLINER M/S	AR	414x150 RT	19934	1993402	RIV818	MAC9934	1993480	
MIDLINER M/S	AR	414x175 RT	19935	1993502	RIV818	MAC9935	1993580	
PREMIUM	AR	414x220 RT	19187	1918702	RIV818	MAC9187	1918780	
PREMIUM Dxi	AV	410x175 MERITOR	19090	1909002	RIVL11	MAC9090/2	1909080	
PREMIUM Dxi	AR	410x200 MERITOR	19071	1907102	RIVL11	MAC9071/2	1907180	
PREMIUM Dxi	AR	410x225 MERITOR	19068	1906802	RIVL10	MAC9068/2	1906880	
R - MAJOR	AV	414x150 BENDIX	19049/19199	1904902	RIV615T11	MAC9049/199		
R - MAJOR	AV	414x150 RT	19934	1993402	RIV818	MAC9934	1993480	
R - MAJOR	AV	414x175 RT	19935	1993502	RIV818	MAC9935	1993580	
R - MAJOR	AR	414x150 RT	19934	1993402	RIV818	MAC9934	1993480	
R - MAJOR	AR	414x175 RT	19935	1993502	RIV818	MAC9935	1993580	
SAVIEM	AV/AR	414x150 BENDIX	19049/19199	1904902	RIV615T11	MAC9049/199		
ROR								
TM, TE AC BRAKE - 17,5"		311x190 CO +0 mm	19604/19605	1960408	RIVL10		1960470	
LM Q+ BRAKE - 22,5"		419x177 CO +0 mm	19030/19033	1903001	RIVL09		1903070	
TM, TE Q BRAKE - 22,5"		419x178 CO +0 mm	19036/19037	1903712	RIVL09		1903770	
TM, TE Q BRAKE - 22,5"		419x178 CR +1 mm	19036/19037	1903713	RIVL09		1903771	
TM Z BRAKE - 22,5"		419x219 CO +0 mm	19369/19370	1936912	RIVL10		1936970	
TM Z BRAKE - 22,5"		419x219 CR +1 mm	19369/19370	1936913	RIVL10		1936971	
SAE DUPILLIER								
S3220, S3320 - 17,5"		305x200 CO +0 mm	19762/19763	1976210	RIV818		1976270	
SAF								
RS 8442 SNF - 22,5"		420x180 CO +0 mm	19032	1903230	RIV815		1903274	
RS 8442 SNF - 22,5"		420x180 CR +1 mm	19032	1903231	RIV815		1903275	
WRZ6242 SNF - 22,5"		420x200 CO +0 mm	19094	1909437	RIV815		1909474	
WRZ6242 SNF - 22,5"		420x200 CR +1 mm	19094	1909439	RIV815		1909475	

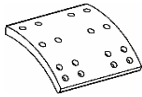

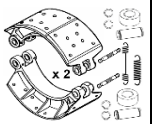



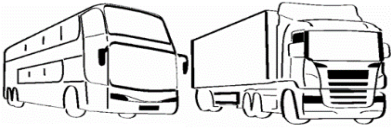

* Kit mâchoires garnies sans accessoires / Lined brake shoes kit without fitting kit

APPLICATION PAR VEHICULES APPLICATION BY VEHICLES

			WVA						
SCANIA									
C-K BUS	AV	412x178 SCANIA	19931	1993101	RIVS38				
C-K BUS	AR	412x254 SCANIA	19933	1993301	RIVS38	MAC9933	1993380		
N - BUS	AV	412x178 SCANIA	19931	1993101	RIVS38				
N - BUS	AR	412x254 SCANIA	19933	1993301	RIVS38	MAC9933	1993380		
SERIE 3 - 93	AV	412x127 SCANIA	17991	1799101	RIVS38				
SERIE 3 - 93	AV	412x178 SCANIA	19931	1993101	RIVS38				
SERIE 3 - 93	AR	412x127 SCANIA	17991	1799101	RIVS38				
SERIE 3 - 93	AR	412x178 SCANIA	19931	1993101	RIVS38				
SERIE 3 - 93	AR	412x203 SCANIA	19932	1993201	RIVS38	MAC9932	1993280		
SERIE 3 - 113	AV	412x127 SCANIA	17991	1799101	RIVS38				
SERIE 3 - 113	AV	412x178 SCANIA	19931	1993101	RIVS38				
SERIE 3 - 113	AR	412x127 SCANIA	17991	1799101	RIVS38				
SERIE 3 - 113	AR	412x178 SCANIA	19931	1993101	RIVS38				
SERIE 3 - 113	AR	412x203 SCANIA	19932	1993201	RIVS38	MAC9932	1993280		
SERIE 3 - 113	AR	412x254 SCANIA	19933	1993301	RIVS38	MAC9933	1993380		
SERIE 3 - 143	AV	412x178 SCANIA	19931	1993101	RIVS38				
SERIE 3 - 143	AR	412x127 SCANIA	17991	1799101	RIVS38				
SERIE 3 - 143	AR	412x178 SCANIA	19931	1993101	RIVS38				
SERIE 3 - 143	AR	412x203 SCANIA	19932	1993201	RIVS38	MAC9932	1993280		
SERIE 3 - 143	AR	412x254 SCANIA	19933	1993301	RIVS38	MAC9933	1993380		
SERIE 4 - 94	AV	412x178 SCANIA	19931	1993101	RIVS38				
SERIE 4 - 94	AV	412x203 SCANIA	19932	1993201	RIVS38	MAC9932	1993280		
SERIE 4 - 94	AR	412x254 SCANIA	19933	1993301	RIVS38	MAC9933	1993380		
SERIE 4 - 94	AR	412x127 SCANIA	17991	1799101	RIVS38				
SERIE 4 - 94	AR	412x203 SCANIA	19932	1993201	RIVS38	MAC9932	1993280		
SERIE 4 - 94	AR	412x178 SCANIA	19931	1993101	RIVS38				
SERIE 4 - 114	AV	412x178 SCANIA	19931	1993101	RIVS38				
SERIE 4 - 114	AV	412x203 SCANIA	19932	1993201	RIVS38	MAC9932	1993280		
SERIE 4 - 114	AR	412x127 SCANIA	17991	1799101	RIVS38				
SERIE 4 - 114	AR	412x178 SCANIA	19931	1993101	RIVS38				

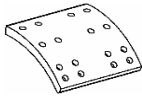

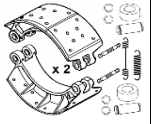



* Kit mâchoires garnies sans accessoires / Lined brake shoes kit without fitting kit

APPLICATION PAR VEHICULES APPLICATION BY VEHICLES

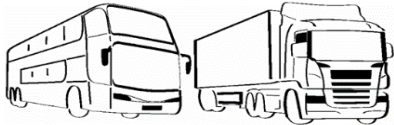
								
SCANIA../..								
SERIE 4 - 114	AR	412x203 SCANIA	19932	1993201	RIVS38	MAC9932	1993280	
SERIE 4 - 114	AR	412x254 SCANIA	19933	1993301	RIVS38	MAC9933	1993380	
SERIE 4 - 124	AV	412x178 SCANIA	19931	1993101	RIVS38			
SERIE 4 - 124	AV	412x203 SCANIA	19932	1993201	RIVS38	MAC9932	1993280	
SERIE 4 - 124	AR	412x127 SCANIA	17991	1799101	RIVS38			
SERIE 4 - 124	AR	412x178 SCANIA	19931	1993101	RIVS38			
SERIE 4 - 124	AR	412x203 SCANIA	19932	1993201	RIVS38	MAC9932	1993280	
SERIE 4 - 124	AR	412x254 SCANIA	19933	1993301	RIVS38	MAC9933	1993380	
SERIE 4 - 144	AV	412x178 SCANIA	19931	1993101	RIVS38			
SERIE 4 - 144	AV	412x203 SCANIA	19932	1993201	RIVS38	MAC9932	1993280	
SERIE 4 - 144	AR	412x178 SCANIA	19931	1993101	RIVS38			
SERIE 4 - 144	AR	412x203 SCANIA	19932	1993201	RIVS38	MAC9932	1993280	
SERIE 4 - 144	AR	412x254 SCANIA	19933	1993301	RIVS38	MAC9933	1993380	
SMB								
C3 - 17,5"		311x203 CO +0 mm	19608/19609	1986201	RIV515TF		1960870	
C2/L2 PROPARG P13, LUN, PSL - 22,5"		419x178 CO +0 mm	19613/19614	1961313	RIV515TF		1961370	
C2/L2 PROPARG P13, LUN, PSL - 22,5"		419x178 CR +1 mm	19613/19614	1961314	RIV515TF		1961371	
C1/L1 - 22,5"		419x203 CO +0 mm	19557/19606	1955713	RIV515TF		1955770	
C1/L1 - 22,5"		419x203 CR +1 mm	19557/19606	1955714	RIV515TF		1955771	
VOLVO TRUCKS								
B-SERIE	AV	410x150 MERITOR	19941	1994102	RIVL09	MAC9941/2	1994180	
B-SERIE	AV	410x175 MERITOR	19090	1909002	RIVL11	MAC9090/2	1909080	
B-SERIE	AV	410x200 MERITOR	19071	1907102	RIVL11	MAC9071/2	1907180	
B-SERIE	AR	410x175 MERITOR	19090	1909002	RIVL11	MAC9090/2	1909080	
B-SERIE	AR	410x225 MERITOR	19068	1906802	RIVL10	MAC9068/2	1906880	
F - SERIE	AV	410x150 MERITOR	19941	1994102	RIVL09	MAC9941/2	1994180	
F - SERIE	AV	410x175 MERITOR	19090	1909002	RIVL11	MAC9090/2	1909080	
F - SERIE	AV	410x200 MERITOR	19071	1907102	RIVL11	MAC9071/2	1907180	
F - SERIE	AV	410x225 MERITOR	19068	1906802	RIVL10	MAC9068/2	1906880	
F - SERIE	AR	410x150 MERITOR	19941	1994102	RIVL09	MAC9941/2	1994180	

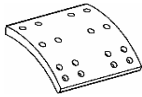
* Kit mâchoires garnies sans accessoires / Lined brake shoes kit without fitting kit

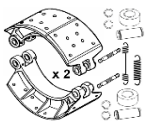
APPLICATION PAR VEHICULES APPLICATION BY VEHICLES

			WVA					
VOLVO TRUCKS ../.								
F - SERIE	AR	410x175 MERITOR	19090	1909002	RIVL11	MAC9090/2	1909080	
F - SERIE	AR	410x200 MERITOR	19071	1907102	RIVL11	MAC9071/2	1907180	
F - SERIE	AR	410x225 MERITOR	19068	1906802	RIVL10	MAC9068/2	1906880	
FH 12/16	AV	410x175 MERITOR	19090	1909002	RIVL11	MAC9090/2	1909080	
FH 12/16	AV	410x200 MERITOR	19071	1907102	RIVL11	MAC9071/2	1907180	
FH 12/16	AR2	410x125 MERITOR	17992	1799201	RIVL09	MAC7992/2	1799280	
FH 12/16	AR	410x200 MERITOR	19071	1907102	RIVL11	MAC9071/2	1907180	
FH 12/16	AR	410x225 MERITOR	19068	1906802	RIVL10	MAC9068/2	1906880	
FL 12/16	AV	410x175 MERITOR	19090	1909002	RIVL11	MAC9090/2	1909080	
FL 12/16	AR	410x225 MERITOR	19068	1906802	RIVL10	MAC9068/2	1906880	
FM 12/16	AV	410x175 MERITOR	19090	1909002	RIVL11	MAC9090/2	1909080	
FM 12/16	AR	410x200 MERITOR	19071	1907102	RIVL11	MAC9071/2	1907180	
FM 12/16	AR	410x225 MERITOR	19068	1906802	RIVL10	MAC9068/2	1906880	
FM 7	AV	410x175 MERITOR	19090	1909002	RIVL11	MAC9090/2	1909080	
FM 7	AR	410x200 MERITOR	19071	1907102	RIVL11	MAC9071/2	1907180	
FM 7	AR	410x225 MERITOR	19068	1906802	RIVL10	MAC9068/2	1906880	
N - SERIE	AV	410x150 MERITOR	19941	1994102	RIVL09	MAC9941/2	1994180	
N - SERIE	AV	410x175 MERITOR	19090	1909002	RIVL11	MAC9090/2	1909080	
N - SERIE	AV	410x200 MERITOR	19071	1907102	RIVL11	MAC9071/2	1907180	
N - SERIE	AV	410x225 MERITOR	19068	1906802	RIVL10	MAC9068/2	1906880	
N - SERIE	AR	410x150 MERITOR	19941	1994102	RIVL09	MAC9941/2	1994180	
N - SERIE	AR	410x175 MERITOR	19090	1909002	RIVL11	MAC9090/2	1909080	
N - SERIE	AR	410x200 MERITOR	19071	1907102	RIVL11	MAC9071/2	1907180	
N - SERIE	AR	410x225 MERITOR	19068	1906802	RIVL10	MAC9068/2	1906880	

Automotive

PIECES DE FREINAGE POUR GRUES MOBILES BRAKE PARTS FOR MOBILE CRANES

	OBS	DETAIL	WVA	
---	------------	---------------	------------	---

Garnitures de frein/ Brake lining

410x180	OLD	8 trous/holes rivet 10x18	19723	19723001549
410x180	NEW	10 trous/holes rivet 8x18	19113	19113001549
500x120	OLD	8 trous/holes rivet 10x18	17237	17237001549
500x120	NEW	10 trous/holes rivet 8x18	17374	17374001549
500x160	OLD	8 trous/holes rivet 10x18	19687	19687001549
500x160	NEW	10 trous/holes rivet 8x18	19042	19042001549
500x180	OLD	8 trous/holes rivet 10x18	19690	19690001549
500x180	NEW	14 trous/holes rivet 8x18	19041	19041001549

Ecarteurs / Expanders

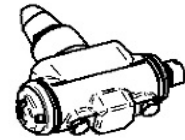

410x180	KNOTT	SIMPLEX		ECF005
410x180	KNOTT	DUPLEX		ECF006
410x180	PERROT	SIMPLEX		ECF003
410x180	PERROT	DUPLEX		ECF004
500x120	KNOTT	SIMPLEX		ECF005
500x120	PERROT	SIMPLEX		ECF003
500x160	KNOTT	SIMPLEX		ECF005
500x160	PERROT	SIMPLEX		ECF003
500x180	KNOTT	DUPLEX		ECF006
500x180	PERROT	DUPLEX		ECF004

Frein Simplex
Simplex Brake

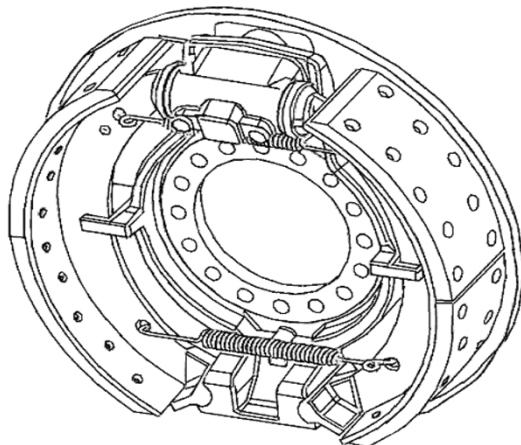

Frein Duplex
Duplex Brake

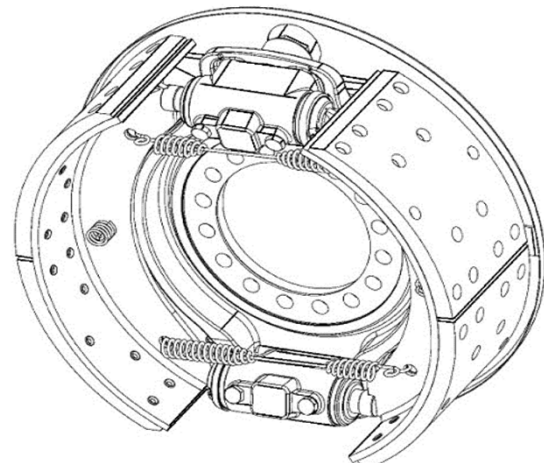

**PIECES DE FREINAGE POUR GRUES MOBILES
BRAKE PARTS FOR MOBILE CRANES**

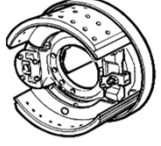
	DETAIL	Ressort Rappel / release spring	ressort compression / presure spring
410x180	SIMPLEX	RES012	
410x180	DUPLEX	RES011	RES010
500x120	SIMPLEX	RES012	
500x160	SIMPLEX	RES012	
500x180	DUPLEX	RES011	RES010



RES010



RES011



RES012



RECHERCHE GARNITURES DE FREIN PAR DIMENSIONS BRAKE LINING RESEARCH BY SIZE

Larg/ Width	Ø Tamb/ Drum	Nbr rivet/s et	Nbr	VVA	REF	Rivet Type	Rivet Textar	Rivet GIL	BFMC	
35	230,0	44	1+1+2	11019/11025/11582	1101901	4x10	86000800	RIV410	MB/90/1; MB/91/03;	MERCEDES PERROT
43	228,6	48	4	11308	11308xx	G05			ST/18/1;	BEDFORD
45	305,0	52	2+2	13464/13465	13464xx	4x8	86000700	RIV408	SA/15/1; SA/16/1;	RT
50	356,0	52	2+2	13053/13145	13053xx	4x8	86000700	RIV408	RN/70/1; RN/71/1;	RT
55	260,0	52	2+2	13020/13532	1302001	4x10	86000800	RIV410	MB/88/1; MB/89/2;	MERCEDES PERROT
60	209,0	48	4	15734	15734xx					STEYR
60	300,0	64	4	15004	1500401				BC/52/1;	BPW
60	350,0	40	4	15044	1504401				FD/85/1;	BPW
62	330,2	48	2+2	15242/15243	15242xx	L07			BO/31/1; BO/32/1;	BEDFORD
65	270,0	40	4	15775	15775xx	4x8			VN/19/1;	VOLKWAGEN
70	300,0	52	2+2	15349/15350	1534906	6x15	87001300	RIV615T11	MB/70/1; MB/69/1;	MERCEDES
70	305,0	52	2+2	15831/15832	1583101	4x8	86000700	RIV408	SA/20/1; SA/21/1;	RT
75	308,0	52	2+2	15838/15837	15837xx	G05			GG/182/1; GG/183/1;	FORD
75	360,0	52	2+2	15104/15107	15104xx	4x8	86000700	RIV408	RN/57/1; RN/58/1;	RT
76	307,9	52	2+2	15662/15664	15662xx	H05				FORD
76	308,0	52	2+2	15562/15564	15562xx	H06			GG/145/1; GG/146/1;	BEDFORD
76	330,0	48	4	15789	15789xx	L07			GG/171/1;	FORD
76	330,2	48	4	15563	15563xx	L09	88000700	RIVL09	GG/149/1;	FORD
80	270,0	52	2+2	15030/15742	1503002	5x10	86001500	RIV510	MB/80/1; MB/81/3;	MERCEDES STEYR PERROT
80	305,0	48	4	15698	15698xx	4x8	86000700	RIV408	SA/14/1;	RT
80	305,0	48	8	15799	15799xx	6x15	87001300	RIV615T11	SE/1/1;	SAE
80	310,0	64	4	55173	55173001517	6x15	87001300	RIV615T11		BPW
80	310,0	64	8	15826	1582602	6x15	87001300	RIV615T11		BPW
80	325,0	52	2+2	15732/15733	1573204	6x12	86002200	RIV612	FI/101/1; FI/100/1;	IVECO PERROT
80	330,2	48	2+2	15280/15281	15280xx	L07			BO/38/1; BO/37/1;	BEDFORD
80	400,0	40	4	15247	1524701	5x10	86001500	RIV510	FD/86/1;	BPW KAESSBOHRER SAF
80	400,0	64	4	15306	1530601	5x10	86001500	RIV510		STEYR KNOTT
80	406,4	64	2+2	15248/15249	15248xx	L07			BO/27/1; BO/28/1;	BEDFORD
81	358,7	64	2+2	15245/15246	15245xx	L07				BEDFORD
81	360,0	64	2+2	15794/15795	15794xx	L07				BEDFORD

Les garnitures de frein avec suffixes xx sont livrables sous 48-72 heures

Brake linings xx suffixes are available in 48-72 hours

RECHERCHE GARNITURES DE FREIN PAR DIMENSIONS BRAKE LINING RESEARCH BY SIZE

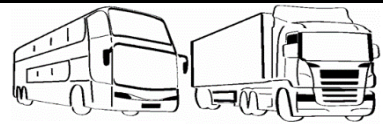
Larg/ Width	Ø Tamb/ Drum	Nbr rivet/s et	Nbr	WVA	REF	Rivet Type	Rivet Textar	Rivet GIL	BFMC	
87	300,0	52	2+2	15059/15869	1505901	6x10	86002100	RIV610	MB/107/1; MB/108/2;	MERCEDES
88	412,8	48	8	15185	15185xx	6,3x18	85000400	RIV6.318	SV/7/1;	SCANIA
90	300,0	40	4	15057	15057xx	8x15	85000600	RIV815	MB/64/1;	MERCEDES
90	308,0	40	4	15162	1516203	8x15	85000600	RIV815	MB/116/2;	MERCEDES
90	325,0	60	2+2	15586/15589	15586xx	5x10	86001500	RIV510		HANOMAG
90	406,0	64	4	15282	15282xx	5x15	86001700	RIV515	BT/48/1;	RT
90	420,0	64	4	15207	1520704	8x18	85000700	RIV818	FI/79/2;	IVECO
90	420,0	64	4	15336	15336xx	8x15	85000600	RIV815	FI/80/1;	IVECO
90	420,0	64	4	15494	15494xx	8x18	85000700	RIV818	FI/84/1;	IVECO
98	300,0	52	2+2	15580/15581	15580xx	6x10	86002100	RIV610	MB/72/1; MB/73/1;	MERCEDES
98	304,0	52	2+2	15580/15581	1558008	6x10	86002100	RIV610	MB/94/1; MB/95/1;	MERCEDES
98	325,0	44	2+2	15817/15823	1581702	8x20	86002900	RIV820	MP/37/1; MP/38/1;	DAF LEYLAND MAN PERROT
99	325,0	48	8	15879	1587906	8x15	87001500	RIV815	GG/209/1;	MAN STEYR
100	300,0	40	4	57251	57251001561	8x15		RIV812		COLAERT ADR
100	300,0	64	8	17347	1734703	8x15	85000600	RIV815		BPW
100	308,0	52	2+2	17934/17935	17934xx	G05			GG/184/1; GG/185/1;	FORD
100	310,0	52	2+2	17099/17096	1709601	6x12	86002200	RIV612	PB/26/1; PB/23/1;	IVECO
100	310,0	56	2+2	17829/17799	17829003529	5x12	86001600	RIV512	BT/76/1; SA/25/1;	RT
100	310,0	56	4	17946	1794600929	5x15	86001700	RIV515		NISSAN
100	310,0	60	2+2	17946/17945	1794500929	5x15	86001700	RIV515		NISSAN
100	325,0	52	2+2	17730/17793	1740805	6x12	86002200	RIV612	OM/12/1; FI/102/1;	IVECO
100	325,0	52	2+2	17924/17925	1792408	6x12	86002200	RIV612	FI/120/1; FI/121/1;	IVECO PERROT
100	325,0	52	2+2	17793/17408	1740805	6x12	86002200	RIV612	FI/102/1; SY/25/1;	IVECO
100	325,0	72	4	17744	17744xx	5x12	86001600	RIV512		RT
100	356,0	60	2+2	17497/17498	17497xx	5x15	86001700	RIV515	BT/52/1; BT/53/1;	RT
100	356,0	64	2+2	17582/17805	17582003548	5x12	86001600	RIV512	BT/53/1; SA/24/1;	RT
100	400,0	32	2+2	17792/17794	17792xx	6x12	86002200	RIV612	FI/108/1; FI/109/1;	IVECO
100	400,0	48	4	17094	1709401	8x15	86002700	RIV815	SY/7/1;	IVECO PERROT
100	400,0	56	2+2	17050/17051	17050xx	6x12	86002200	RIV612	MF/1/1; MF/2/1;	PERROT
100	400,0	64	4+4	17372/17373	17372xx	8x15	86002700	RIV815	FI/148/1; FI/149/1;	IVECO

Les garnitures de frein avec suffixes xx sont livrables sous 48-72 heures

Brake linings xx suffixes are available in 48-72 hours

RECHERCHE GARNITURES DE FREIN PAR DIMENSIONS BRAKE LINING RESEARCH BY SIZE

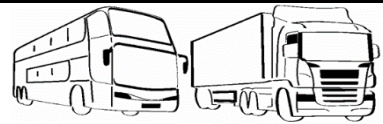
Larg/ Width	Ø Tamb/ Drum	Nbr rivet/s et	Nbr	VVA	REF	Rivet Type	Rivet Textar	Rivet GIL	BFMC	
100	406,0	48	8	17760	17760xx	6x15	87001300	RIV615T11	SAE	
100	406,0	52	2+2	17247/17305	17247xx	5x15	86001700	RIV515	SA/8/1; SA/9/1;	COLAERT RT
100	406,0	54	2+2	17247/17305	17247xx	5x12	86001600	RIV512		COLAERT RT
100	406,0	80	2+2	17500/17506	17500xx	5x12	86001600	RIV512		RT
100	410,0	64	8	17739	17739xx	8x18	85000700	RIV818		MERCEDES
100	418,0	64	8	17297	17297xx	8x15	85000600	RIV815	MB/67/1;	MERCEDES
100	441,4	64	8	17669	17669xx	10x18	87002000	RIV1018		PERROT
100	500,0	64	8	17273	17273xx	10x18	87002000	RIV1018		PERROT
101	307,9	52	2+2	17556/17558	17556xx	H06			GG/148/1; GG/147/1;	LEYLAND
101	330,2	48	4	17555	17555xx	L07			GG/144/1;	FORD
101	334,0	64	4	17940	17940xx	G07			LH/94/1;	LEYLAND
101	406,4	80	4+4	17383/17384	17383xx	6,5x17,6	85001700	RIV6.517	DF/10/3; DF/11/3;	DAF
102	300,0	52	2+2	17350/17973	1735003	6x10	86002100	RIV610	MB/100/1; MB/101/2;	MERCEDES
104	304,0	40	4	17927	17927xx	8x15	85000600	RIV815	MB/96/1;	MERCEDES
104	308,0	40	4	17278	1727806	8x15	85000600	RIV815	MB/109/2;	MERCEDES
106	330,2	48	2+2	17230/17229	17229xx	L07			BO/40/1; BO/39/1;	BEDFORD
106	358,7	64	2+2	17478/17477	17477xx	L07			BO/57/1; BO/58/1;	BEDFORD
106	409,4	64	2+2	17854/17855	17854xx	L09	88000700	RIVL09	BO/54/1; BO/53/1;	BEDFORD
108	387,4	48	4	17134	17134xx	L09	88000700	RIVL09	GG/77/1;	FORD
108	387,4	56	4	17557	17557xx	L09	88000700	RIVL09	GG/157/1;	FORD
114	393,7	48	2+2	17117/17116	17116xx	L12	88000900	RIVL11	LE/63/1; LE/63/2;	LEYLAND
119	304,0	40	4	17928	17928xx	8x15	85000600	RIV815	MB/97/1;	MERCEDES
119	308,0	40	4	17280	1728006	8x15	85000600	RIV815	MB/110/1; MB/110/2;	MERCEDES
120	325,0	52	2+2	17088/17635	1708802	6x12	86002200	RIV612	SY/20/2; SY/26/1;	IVECO OM PERROT
120	325,0	60	2+2	17827/17828	1782704	5x12	86001600	RIV512	SA/28/1; SA/29/1;	DAF IVECO RT
120	325,0	64	4	17339	17339xx	6x12	86002200	RIV612		PERROT
120	400,0	48	4	17275	17275xx	8x15	86002700	RIV815	KM/10/1;	IVECO
120	400,0	64	8	17115	1711501	8x15	85000600	RIV815	BC/39/1;	BPW SAE SAF
120	400,0	64	8	17001	1700101	8x15	85000600	RIV815		BPW SAF
120	400,0	64	8	17115	1711501	8x15	85000600	RIV815	BC/39/1;	BPW SAE SAF

Les garnitures de frein avec suffixes xx sont livrables sous 48-72 heures

Brake linings xx suffixes are available in 48-72 hours

RECHERCHE GARNITURES DE FREIN PAR DIMENSIONS BRAKE LINING RESEARCH BY SIZE

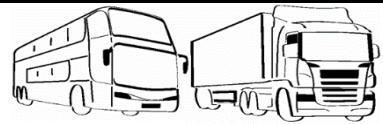
Larg/ Width	Ø Tamb/ Drum	Nbr rivet/s et	Nbr	VVA	REF	Rivet Type	Rivet Textar	Rivet GIL	BFMC	
120	406,0	64	8	17016	17016301561	8x12		RIV812	BC/38/1;	COLAERT
120	408,0	64	8	17259	17259xx	8x15	85000600	RIV815	MB/56/1;	MERCEDES
120	410,0	64	8	17682	1768202	8x15	85000600	RIV815	MP/29/1;	MAN MERCEDES
120	410,0	80	8	17405	1740501	8x15	85000600	RIV815		BPW
120	418,0	64	8	17298	17298xx	8x15	85000600	RIV815	MB/68/1;	MERCEDES
120	420,0	48	8	17888	1788802	8x18	85000700	RIV818		IKARUS
120	420,0	64	8	17184	1718401	8x18	85000700	RIV818		KAROSA LIAZ
120	420,0	80	8	17377	1737707	8x15	85000600	RIV815	BC/78/1;	BPW KAESBOHRER SAF
120	500,0	64	8	17237	17237001549	10x18	87002000	RIV1018	PB/15/1;	PERROT
120	500,0	80	8	17374	17374001549	8x20	86002900	RIV820	PB/15/2;	PERROT
121	300,0	52	2+2	17351/17975	1735103	6x10	86002100	RIV610	MB/117/1; MB/118/2;	MERCEDES
123	410,0	64	8	17992	1799201	L09	88000700	RIVL09	VL/85/1;	VOLVO
124	330,2	48	4	17217	17217xx	L09	88000700	RIVL09	GG/194/1;	DAF FORD
125	305,0	48	4	17612	17612xx	6x15	87001300	RIV615T11		TRAILOR
125	305,0	48	8	17592	17592xx	6x15	87001300	RIV615T11		SAE
125	305,0	48	4+4	17897/17898	17897xx	8x18	87001600	RIV818	LZ/7/1; LZ/8/1;	SAE
125	310,0	64	2+2	17831/17832	1783102	5x12	86001600	RIV512	SA/27/1; SA/26/1;	DAF RT VOLVO
125	310,0	72	4	17352	17352xx	5x12	86001600	RIV512	RN/104/1;	RT
125	406,0	48	8	17761	17761xx	6x15	87001300	RIV615T11		SAE
125	406,0	96	2+2	17307/17308	17307xx	5x15	86001700	RIV515	BT/54/1; BT/55/1;	RT
125	406,0	104	2+2	17704/17705	17704xx	5x15	86001700	RIV515	BT/69/1; BT/70/1;	RT
125	414,0	96	2+2	17309/17531	17309007000	6x15	87001300	RIV615T11	BT/57/7; BT/56/7;	RT
125	420,0	64	4	17481	1748107	8x15	86002700	RIV815	FI/86/2;	IVECO VANHOOL
125	420,0	96	4	17482	1748206	8x18	85000700	RIV818	FI/94/1;	IVECO
127	311,0	80	4+4	17942/17943	17942xx	L10	88000800	RIVL10		YORK
127	330,2	48	4	17560	17560xx	L09	88000700	RIVL09	GG/156/1;	FORD
127	330,2	52	2+2	17663/17662	17662xx	L07			GG/164/1; GG/163/1;	LEYLAND
127	330,2	56	2+2	17932/17933	17932xx	L07			GG/187/1; GG/186/1;	FORD
127	387,4	48	4	17132	17132xx	L07			LE/54/1;	DAF
127	393,7	48	4	17546	17546xx	L07			GG/118/1;	DENNIS

Les garnitures de frein avec suffixes xx sont livrables sous 48-72 heures

Brake linings xx suffixes are available in 48-72 hours

RECHERCHE GARNITURES DE FREIN PAR DIMENSIONS BRAKE LINING RESEARCH BY SIZE

Larg/ Width	Ø Tamb/ Drum	Nbr rivet/s et	Nbr	VVA	REF	Rivet Type	Rivet Textar	Rivet GIL	BFMC	
127	393,7	48	4	17316	17316xx	L09	88000700	RIVL09	GG/153/1; FD/153/1;	FORD
127	393,7	64	4	17766	17766xx	L07			DF/28/1;	DAF
127	393,7	64	4	17804	17804003657	6x15	86002300	RIV615	DO/80/2;	RT
127	400,0	64	4+4	17185/17186	17185xx	L09	88000700	RIVL09	SV/28/1; SV/29/1;	SISU
127	406,0	64	8	17996	17996xx	L09	88000700	RIVL09	NN/60/1;	HINO
127	406,4	80	4+4	17324/17325	17324xx	6,5x17,6	85001700	RIV6.517	DF/15/3; DF/14/3;	BOVA DAF
127	409,4	64	2+2	17714/17713	17713xx	L09	88000700	RIVL09	BO/56/1; BO/55/1;	BEDFORD
127	412,7	72	4+4	17664/17665	1766402	L10	88000800	RIVL10	VL/71/1; VL/70/1;	VOLVO
127	412,8	32	4	17991	1799101	S38	85002100	RIVS38	SV/39/2;	SCANIA
127	412,8	64	8	17161	1716101	6,3x18	85000400	RIV6.318	SV/26/1;	SCANIA
127	419,0	80	4+4	17012/17013	17012xx	6,5x17,6	85001700	RIV6.517	DF/41/1; DF/40/1;	DAF
127	419,1	80	4+4	17263/17264	1726301	6,5x17,6	85001700	RIV6.517	DF/22/3; DF/23/3;	DAF NEOPLAN
129	360,0	56	4+4	17949/17950	17949xx	8x15	85000600	RIV815	MB/98/1; MB/99/1;	MERCEDES
129	364,0	56	4+4	17290/17950	1729006	8x15	85000600	RIV815	MB/111/1; MB/112/1;	MERCEDES
134	304,0	40	4	17929	17929xx	8x15	87001500	RIV815	MB/102/1;	MERCEDES
134	308,0	40	4	17287	1728705	8x15	85000600	RIV815	MB/115/1; MB/115/2;	MERCEDES
135	300,0	40	4	57248	57248001561	8x15		RIV812		COLAERT ADR
135	300,0	40	4	57250	57250001561	8x15		RIV812		COLAERT ADR
135	300,0	40	4	17409	1740910	8x15	87001500	RIV815	MB/71/1;	MERCEDES
135	420,0	64	8	17885	17885xx	8x18	85000700	RIV818	FI/113/1;	IVECO
138	420,0	48	8	17746	17746xx	8x18	85000700	RIV818		IKARUS
139	330,3	60	2+2	17941/17939	17939xx	L06			LH/98/1; LH/99/1;	LEYLAND
139	360,0	112	4+4	17357/17358	1735702	L09	88000700	RIVL09	GG/233/1; GG/234/1;	VOLVO
140	325,0	48	4	17688	1768801	6x12	86002200	RIV612	SY/22/1;	IVECO
140	325,0	52	2+2	17879/17880	17880xx	6x12	86002200	RIV612	SY/32/1; SY/22/1;	IVECO
140	325,0	56	4	17879	17879xx	6x12	86002200	RIV612	SY/32/1; FI/126/1;	IVECO
140	400,0	48	4	17248	17248xx	8x18	85000700	RIV818	BC/32/2;	IVECO
140	400,0	56	2+2	17270/17269	17269xx	8x15	86002700	RIV815	BC/33/1; BC/32/1;	IVECO
140	406,0	64	8	17336	1733630934	8x18	85000700	RIV818		ADR
140	410,0	64	8	17238	1723802	8x15	85000600	RIV815	MP/30/2;	MAN MERCEDES

Les garnitures de frein avec suffixes xx sont livrables sous 48-72 heures

Brake linings xx suffixes are available in 48-72 hours

RECHERCHE GARNITURES DE FREIN PAR DIMENSIONS BRAKE LINING RESEARCH BY SIZE

Larg/ Width	Ø Tamb/ Drum	Nbr rivet/s et	Nbr	VVA	REF	Rivet Type	Rivet Textar	Rivet GIL	BFMC	
140	410,0	64	4+4	17742/17743	17742xx	10x18	87002000	RIV1018	PB/10/1; PB/9/1;	KAESSBOHRER
140	410,0	72	4+4	17971/17972	17971xx	6x15	87001300	RIV615T11	PD/6/1; PD/5/1;	PEGASO
140	418,0	64	8	17105	17105xx	8x15	85000600	RIV815	MB/65/1;	MERCEDES
140	420,0	48	4	17300	17300xx	10x18	87002000	RIV1018	KM/11/1;	MAN
140	420,0	56	4+4	17869/17870	17869xx	8x18	85000700	RIV818	FI/105/1; FI/100/1;	IVECO
140	420,0	56	4+4	17410/17411	17410xx	10x18	87002000	RIV1018	MP/35/1; MP/34/1;	MAN
140	420,0	64	4	17323	17323xx	8x15	86002700	RIV815	FI/81/1;	IVECO
140	420,0	80	8	17456	1745605	8x18	85000700	RIV818	BC/109/1;	BPW
140	430,0	64	8	17276	1727601	8x20	86002900	RIV820	MB/60/1;	MERCEDES
140	440,0	64	8	17285	17285xx	8x18	85000700	RIV818	BC/2/1;	MAN
143	360,0	64	8	17017	1701703	8x15	85000600	RIV815	GG/217/1;	MAN RT
143	410,0	72	4+4	17795/17796	1779501	8x18	85000700	RIV818	MB/83/1; MB/82/1;	MERCEDES
147	325,0	44	2+2	17900/17901	1790007	8x20	86002900	RIV820	MP/39/1; MP/40/1;	DAF LEYLAND MAN NEOPLAN PERROT
148	410,0	96	8	19941	1994102	L09	88000700	RIVL09	VL/86/1;	VOLVO
148	420,0	64	4+4	19010/19011	1901005	6,5x17,6	85001700	RIV6.517	DF/45/1; DF/44/1;	DAF
149	325,0	64	8	17988	1798806	8x15	87001500	RIV815	GG/210/1;	MAN STEYR
150	300,0	40	4	59338	59338001561	8x18	85000600	RIV815		COLAERT ADR
150	300,0	64	8	19573	1957306	8x15	85000600	RIV815	BC/79/1;	BPW
150	300,0	64	8	19102	1910205	8x15	85000600	RIV815	BC/54/1;	BPW SAF
150	300,0	64	8	19396	19396001541	8x15	85000600	RIV815		BPW
150	300,0	64	8	19596	1959601	8x18	85000700	RIV818		WARSTEIN
150	300,0	64	4+4	19517/19518	1951701	8x15	85000600	RIV815	SJ/25/1; SJ/24/1;	SAE SAF
150	305,0	48	4+4	19760/19761	1976002	8x18	87001600	RIV818	SA/36/1; SA/37/1;	SAE
150	305,0	64	8	19401	19401xx	5x15	86001700	RIV515	SJ/36/1;	SAE
150	325,0	64	2+2	19620/19621	1962004	5x12	86001600	RIV512	SA/31/1; SA/30/1;	DAF IVECO RT
150	325,0	72	4	19709	19709xx	5x12	86001600	RIV512	RN/106/1;	RT
150	335,0	64	8	17362	17362xx	L09	88000700	RIVL09	YK/13/1;	YORK
150	356,0	64	8	19544	19544xx	5x15	86001700	RIV515	RW/29/2;	TRAILOR
150	356,0	80	4+4	19912/19913	1991201	8x18	85000700	RIV818	LZ/5/1; LZ/4/1;	SAE SAF TRAILOR
150	400,0	80	4+4	19168/19169	19168xx	8x18	85000700	RIV818	BC/92/1; BC/93/1;	KAESSBOHRER

Les garnitures de frein avec suffixes xx sont livrables sous 48-72 heures

Brake linings xx suffixes are available in 48-72 hours

RECHERCHE GARNITURES DE FREIN PAR DIMENSIONS BRAKE LINING RESEARCH BY SIZE

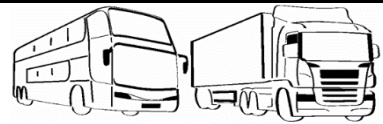
Larg/ Width	Ø Tamb/ Drum	Nbr rivet/s et	Nbr	VVA	REF	Rivet Type	Rivet Textar	Rivet GIL	BFMC	
150	410,0	96	4+4	19144/19145	19144xx	6x18	86002400	RIV618	SV/43/1; SV/44/1;	SISU
150	414,0	64	8	19934	1993402	8x18	85000700	RIV818	RN/100/1;	RT
150	414,0	72	4	19919	19919xx	8x18	85000700	RIV818	BT/84/1;	RT
150	414,0	96	2+2	19049/19199	1904902	6x15	87001300	RIV615T11	SA/10/1; SA/11/1;	RT
150	414,0	104	4	19680	19680xx	6x15	87001300	RIV615T11	SA/34/1;	RT
150	419,0	96	4+4	19672/19673	19672xx	5x14,2	85000500	RIV515TF	FT/8/1; FT/9/1;	FRUEHAUF
150	420,0	64	8	19410	1941001	8x18	85000700	RIV818		KAROSA LIAZ
150	420,0	64	4+4	19900/19901	1990002	L10	88000800	RIVL10	DF/34/1; DF/35/1;	DAF
151	414,0	64	4+4	19359/19360	19359xx	6x18	86002400	RIV618		TRAILOR
152	381,0	64	8	19502	1950200412	L10	88000800	RIVL10		MACK RENAULT TRUCKS
152	381,0	96	8	19742	1974200929	L10	88000800	RIVL10		MACK RENAULT TRUCKS
152	393,7	48	4	19351	19351xx	L09	88000700	RIVL09	GG/140/1;	FORD
152	393,7	48	4	19072	19072xx	L09	88000700	RIVL09	GG/83/1;	LEYLAND
152	393,7	48	4	19172	19172xx	L09	88000700	RIVL09	AL/49/1;	LEYLAND
152	393,7	48	4+4	19583/19584	19583xx	L10	88000800	RIVL10	LE/67/1; LE/68/1;	SCAMMELL
152	393,7	64	4	19593	19593xx	L07			DF/29/1;	DAF
152	393,7	64	4	19622	19622xx	6x15	87001300	RIV615T11	LH/82/2;	RT
152	393,7	64	8	19905	19905xx	L09	88000700	RIVL09	CW/10/1;	FORD
152	393,7	64	4+4	19852/19853	19852xx	L10	88000800	RIVL10	YK/2/2; YK/1/2;	YORK
152	393,7	96	8	19662	19662xx	L12	88000900	RIVL11		LEYLAND
152	412,7	88	4+4	19560/19561	1956002	L10	88000800	RIVL10	VL/74/1; VL/75/1;	VOLVO
152	419,0	80	4+4	19024/19031	1902401	6,5x17,6	85001700	RIV6.517	DF/43/1; DF/42/1;	DAF
152	419,1	64	4+4	19118/19117	19117xx	L10	88000800	RIVL10	DF/20/1; DF/21/1;	DAF
152	419,1	80	4+4	19150/19151	1915002	L09	88000700	RIVL09	DF/20/3; DF/21/3;	BOVA DAF
152	419,1	96	4+4	19696/19695	19696xx	10-9			IL/68/5 ; IL/69/5 ;	ROCKWELL
155	410,0	48	4	18017	18017xx	L10	88000800	RIVL10	LE/70/1;	LEYLAND
159	360,0	56	4+4	19844/19845	19844xx	8x15	85000600	RIV815	MB104/1; MB/105/1;	MERCEDES
159	364,0	56	4+4	19506/19845	1950607	8x15	85000600	RIV815	MB113/1; MB/114/1;	MERCEDES
160	300,0	40	4	59335	59335001561	8x15	85000600	RIV815		COLAERT ADR
160	325,0	52	2+2	19821/19822	19821xx	6x12	86002200	RIV612	SY/33/1; SY/34/1;	IVECO

Les garnitures de frein avec suffixes xx sont livrables sous 48-72 heures

Brake linings xx suffixes are available in 48-72 hours

RECHERCHE GARNITURES DE FREIN PAR DIMENSIONS BRAKE LINING RESEARCH BY SIZE

Larg/ Width	Ø Tamb/ Drum	Nbr rivet/s et	Nbr	VVA	REF	Rivet Type	Rivet Textar	Rivet GIL	BFMC	
160	350,0	40	4	57335	57335xx	8x15		RIV812		COLAERT ADR
160	360,0	72	4+4	19952/19953	1995201	8x15	85000600	RIV815	BC/104/1; BC/105/1;	BPW
160	370,0	64	8	19125	19125xx	8x15	85000600	RIV815	MB/61/1;	MERCEDES
160	410,0	64	8	19713	1971301	8x15	85000600	RIV815		MAN
160	410,0	64	8	19494	1949402	8x15	85000600	RIV815	MP/31/2;	MERCEDES
160	410,0	64	4+4	19634/19635	19634xx	10x18	87002000	RIV1018	PB/27/1; PB/28/1;	KAESSBOHRER
160	410,0	64	4+4	19849/19850	1984906	10x18	87002000	RIV1018	PB/17/1; PB/16/1;	KAESSBOHRER PERROT
160	410,0	72	4+4	19579/19580	1957901	8x18	85000700	RIV818	MB/75/1; MB/74/1;	MAN MERCEDES
160	410,0	72	4+4	19579/19706	1970601	8x18	85000700	RIV818	MB/75/1; MB/74/2;	MERCEDES
160	410,0	100	4+4	19877/19878	1987701	6x15	87001300	RIV615T11	PD/8/1; PD/7/1;	PEGASO
160	418,0	64	8	19182	19182xx	8x15	85000600	RIV815	MB/66/1;	MERCEDES
160	420,0	32	4	19245	19245xx	10x18	87002000	RIV1018	SY/23/1;	STEYR
160	420,0	64	8	19648	19648xx	8x15	85000600	RIV815		TATRA
160	420,0	64	8	19411	1941101	8x18	85000700	RIV818		TATRA
160	420,0	80	8	19200	1920005	8x15	85000600	RIV815	BC/35/1;	BPW FRUEHAUF SAE SAF
160	420,0	80	8	19200	1920005	8x15	85000600	RIV815	BC/35/1;	BPW FRUEHAUF SAE SAF
160	440,0	60	2+2	19153/19154	19153xx	8x18	85000700	RIV818		IVECO
160	440,0	60	4+4	19473/19474	19473xx	10x18	87002000	RIV1018	MP/25/1; MP/26/1;	MAN
160	500,0	64	8	19687	19687001549	10x18	87002000	RIV1018	PB/14/1;	PERROT
160	500,0	80	8	19042	19042001549	8x20	86002900	RIV820	PB/14/2;	PERROT
163	360,0	96	8	19177	1917705	8x15	85000600	RIV815	GG/218/1;	MAN TVM
163	360,0	112	4+4	19640/19701	1964001	L09	88000700	RIVL09		VOLVO
169	360,0	84	2+2	19269/19272	1926901	L09	88000700	RIVL09	GG/208/1; GG/207/1;	VOLVO
169	360,0	96	4+2	19543/19552	19543xx	L09	88000700	RIVL09	GG/214/1; GG/215/1;	VOLVO
170	360,0	72	4	19503	1950308	8x16	85002200	RIV816	PB/22/1;	DAF DENNIS IVECO LEYLAND PERROT
170	360,0	72	4	19225	1922507	8x18	87001600	RIV818	FI/124/2;	DENNIS IVECO NEOPLAN PERROT
170	360,0	72	4	19918	19918xx	8x15	87001500	RIV815	FI/124/1;	IVECO
170	360,0	80	2+2	19255/19259	1925501	5x12	86001600	RIV512	RN/102/1; RN/103/1;	RT
170	360,0	88	4	19923	19923xx	L09	88000700	RIVL09	GG/211/1; RPP GG/216/1;	DAF
170	360,0	96	8	19306	19306007000	L10	88000800	RIVL10	GG/216/1;	DAF

Les garnitures de frein avec suffixes xx sont livrables sous 48-72 heures

Brake linings xx suffixes are available in 48-72 hours

RECHERCHE GARNITURES DE FREIN PAR DIMENSIONS BRAKE LINING RESEARCH BY SIZE

Larg/ Width	Ø Tamb/ Drum	Nbr rivet/s et	Nbr	VVA	REF	Rivet Type	Rivet Textar	Rivet GIL	BFMC	
170	360,0	96	8	19928	1992802	L10	88000800	RIVL10	RW/26/1;	NISSAN STEYR
170	360,0	112	4+4	19758/19759	1975803	L09	88000700	RIVL09	GG/235/1; GG/236/1;	VOLVO
170	440,0	64	8	19160	1916001	8x20	86002800	RIV818ST	MB/51/1;	MERCEDES
173	410,0	112	8	19090	1909002	L11	88000900	RIVL11	VL/87/2; (VL/87/1);	DENNIS RENAULT TRUCKS VOLVO
173	420,0	96	4+4	19052/19055	1905201	6,5x17,6	85001700	RIV6.517	DF/47/1; DF/46/1;	DAF
175	393,7	72	8	19684	19684xx	L10	88000800	RIVL10	GG/180/1;	DENNIS LEYLAND
175	414,0	64	8	19935	1993502	8x18	85000700	RIV818	RN/101/1;	RT
175	414,0	72	8	19463	1946301	8x18	85000700	RIV818	BT/59/5;	RT
175	414,0	84	4	19655	19655xx	8x18	85000700	RIV818	BT/59/7;	RT
175	414,0	92	2+2	19548/19549	19548xx	6x18	86002400	RIV618	LF/100/1; LF/101/1;	RT
175	414,0	104	4	19682	19682xx	6x15	87001300	RIV615T11	SA/35/1;	RT
175	420,0	96	4+4	19888/19889	1988802	L10	88000800	RIVL10	DF/37/1; DF/36/1;	DAF
177	311,0	96	4+4	19783/19784	19783xx	L09	88000700	RIVL09	MQ/3/3; MQ/4/3;	ROR
177	393,7	64	8	19771	19771xx	L09	88000700	RIVL09	GG/155/1;	DENNIS LEYLAND
177	393,7	68	2+2	19179/19178	19178xx	L12	88000900	RIVL11	LE/64/2; LE/64/1;	LEYLAND
177	393,7	72	4	19111	1911101	L09	88000700	RIVL09	GG/92/1;	ERF FORD LEYLAND PEGASO YORK
177	393,7	96	8	19744	19744xx	L10	88000800	RIVL10	CS/63/1;	DENNIS ERF
177	393,7	96	8	18008	18008xx	L09	88000700	RIVL09	CS/68/2;	DENNIS
177	412,8	96	8	19075	1907502	6,3x18	85000400	RIV6.318	SV/8/1;	NEOPLAN SCANIA
177	419,1	80	8	19746	19746xx	8x18	85000700	RIV818	FO/34/1;	FODEN
177	419,1	96	4+4	19030/19033	1903001	L09	88000700	RIVL09	RW/34/1; RW/35/1;	ROR
177	419,1	96	4+4	19981/19982	1998101	L09	88000700	RIVL09		ROR
178	381,0	96	8	19384	1938414	L10	88000800	RIVL10	CW/4/1;	VOLVO
178	381,0	96	6+2	19384/19385	1938414	10.10	85001400	RIV10-10	CW/4/1; CW/4/2;	IVECO VANHOOL VOLVO ROCKWELL
178	393,5	84	4+4	19467/19468	1946703	L11	88000900	RIVL11	VL/73/2; VL/72/1;	VOLVO
178	393,7	96	4+4	19333/19334	1933301	L09	88000700	RIVL09	YK/7/2; YK/6/2;	YORK
178	393,7	128	8	19887	19887xx	L09	88000700	RIVL09	CW/11/1;	FORD
178	400,0	96	4+4	19104/19105	19104xx	L09	88000700	RIVL09	SV/30/1; SV/31/1;	SISU
178	410,0	96	4+4	18019	18019xx	6x18	86002400	RIV618	SV/45/1; SV/46/1;	SISU
178	412,8	64	4	19931	1993101	S38	85002100	RIVS38	SV/40/2;	SCANIA

Les garnitures de frein avec suffixes xx sont livrables sous 48-72 heures

Brake linings xx suffixes are available in 48-72 hours

RECHERCHE GARNITURES DE FREIN PAR DIMENSIONS BRAKE LINING RESEARCH BY SIZE

Larg/ Width	Ø Tamb/ Drum	Nbr rivet/s et	Nbr	VVA	REF	Rivet Type	Rivet Textar	Rivet GIL	BFMC	
178	419,1	96	4+4	19036/19037	1903712	L09	88000700	RIVL09	IL/66/3; IL/67/3;	TRAILOR
178	419,1	96	4+4	19036/19037	1903616	5x14,2	85000500	RIV515TF	DF/24/1; DF/25/1;	TRAILOR
178	419,1	96	4+4	19036/19037	1903712	L10	88000800	RIVL10	IL/66/5; IL/67/5;	TRAILOR
178	419,1	112	4+4	19256/19260	1925602	L09	88000700	RIVL09	DF/16/2; DF/17/2;	BOVA DAF NEOPLAN
178	419,1	128	4+4	19613/19614	1961313	5x14,2	85000500	RIV515TF	FT/12/1; FT/11/1;	SMB C2
178	420,0	64	4+4	19283/19284	1928308	8x15	85000600	RIV815	SJ/28/1; SJ/29/1;	SAE SAF
178	420,0	112	8	19896	19896xx	L10	88000800	RIVL10	AX/14/6;	VAN HOOL
178	420,0	128	4+4	19636/19637	1963603				RW/5/4; RW/6/4;	VALX
180	305,0	64	4	19444	19444xx	6x15	87001300	RIV615T11		TRAILOR
180	367,0	64	4+4	19479/19480	1947905	8x15	86002700	RIV815	SJ/32/1; SJ/33/1;	SAE SAF
180	381,0	96	8	19492	19492xx	L09	88000700	RIVL09	RW/24/1;	VOLVO
180	410,0	64	8	19495	1949502	8x18	85000700	RIV818	MP/32/2;	MAN MERCEDES
180	410,0	64	8	19723	19723001549	10x18	87002000	RIV1018	PB/40/1;	PERROT
180	410,0	64	4+4	19855/19856	1985502	10x18	87002000	RIV1018	PB/29/1; PB/30/1;	KAESSBOHRER PERROT
180	410,0	64	4+4	19558/19559	19558xx	10x18	87002000	RIV1018	PB/11/1; PB/12/1;	KAESSBOHRER PERROT
180	410,0	64	4+4	19946/19947	19946xx	10x18	87002000	RIV1018	PB/36/1; PB/37/1;	VAN HOOL
180	410,0	72	4	18018	18018xx	L10	88000800	RIVL10	LE/71/1;	LEYLAND
180	410,0	80	8	19081	1908101	8x15	85000600	RIV815		BPW
180	410,0	80	8	19113	19113001549	8x20	86002900	RIV820	PB/40/2;	PERROT
180	410,0	96	4+2+2	19556/714/715	1971401	8x18	87001500	RIV815	RW/28/1; RW/30/1; RW/31/1	IVECO ROCKWELL SIMPLEX
180	410,0	96	4+4	19109/19110	1910902	8x15	85002200	RIV816	RW/36/1; RW37/1;	IVECO ROCKWELL DUPLEX
180	410,0	96	6+2	19555/19556	1955502	8x18	87001500	RIV815	RW/28/2; RW/28/1;	IVECO ROCKWELL SIMPLEX
180	410,0	112	8	19342	1934202	8x16	85002200	RIV816	PB/25/2;	IVECO PERROT
180	419,0	64	8	19449	19449xx	8x18	85000700	RIV818		TATRA
180	420,0	72	8	19235	1923502	8x18	85000700	RIV818		IKARUS RABA
180	420,0	80	8	19191	1919101	8x15	85000600	RIV815		BPW
180	420,0	80	8	19032	1903230	8x15	85000600	RIV815	BC/98/1;	BPW
180	420,0	96	8	19972	1997201	8x15	85000700	RIV818		KAROSA
180	420,0	112	8	19236	1923601	8x18	85000700	RIV818		IKARUS
180	420,0	128	8	19694	19694xx	8x18	85000700	RIV818	FI/106/1;	IVECO VAN HOOL

Les garnitures de frein avec suffixes xx sont livrables sous 48-72 heures

Brake linings xx suffixes are available in 48-72 hours

RECHERCHE GARNITURES DE FREIN PAR DIMENSIONS BRAKE LINING RESEARCH BY SIZE

Larg/ Width	Ø Tamb/ Drum	Nbr rivet/s et	Nbr	VVA	REF	Rivet Type	Rivet Textar	Rivet GIL	BFMC	
180	440,0	60	4+4	19475/19476	19475xx	10x18	87002000	RIV1018	MP/27/1; MP/28/1;	MAN
180	500,0	64	8	19690	19690001549	10x18	87002000	RIV1018	PB/13/1;	PERROT
180	500,0	112	8	19041	19041001549	8x20	86002900	RIV820	PB/13/2;	PERROT
182	410,0	96	6+2	19099/19100	1909902	8x16	85002200	RIV816	PB/41/1; PB/41/2;	IVECO
183	360,0	96	8	19708	1970803	8x15	85000600	RIV815	GG/232/1;	MAN
185	420,0	64	8	19246	19246xx	10x18	87002000	RIV1018	SY/24/1;	STEYR
190	310,0	80	4+4	19604/19605	1960408	L10	88000800	RIVL10	RW/9/3; RW/13/3;	ROR
196	406,0	80	4+4	17338/17341	17338xx					HINO
198	410,0	112	8	19071	1907102	L11	88000900	RIVL11	VL/88/2; (VL/88/1);	DAF DENNIS IRISBUS RENAULT TRUCKS VOLVO
198	420,0	128	4+4	19063/19064	1906303	6,5x17,6	85001700	RIV6.517	DF/49/1; DF/48/1;	DAF
199	393,7	128	4+4	19820	19820xx	L09	88000700	RIVL09	GG/189/1;	LEYLAND
200	300,0	64	8	19397	19397xx	8x15	85000600	RIV815	BC/111/1;	BPW
200	300,0	64	8	19574	1957427	8x15	85000600	RIV815	BC/80/1;	BPW GIGANT
200	300,0	64	8	19103	1910301	8x15	85000600	RIV815	BC/55/1;	BPW KAESSBOHRER SAE SAF
200	300,0	64	8	19568	1956801	8x15	85000600	RIV815	BC/108/1;	KAESSBOHRER
200	300,0	64	4+4	19515/19516	1951512	8x15	85000600	RIV815	SJ/23/1; SJ/22/1;	KAESSBOHRER LAG SAF PERROT
200	300,0	96	4+4	19967/19968	1996708	5x14,2	85000500	RIV515TF	BC/106/1; BC/107/1;	TRAILOR
200	305,0	56	4	19996	1999600412	8x15	85000600	RIV815	LZ/1/1;	COLAERT
200	305,0	64	8	19103	19103xx	8x15	85000600	RIV815	SE/6/1;	BPW KAESSBOHRER SAE SAF
200	305,0	64	4+4	19762/19763	1976210	8x18	87001600	RIV818	LZ/2/1; LZ/3/1;	SAE
200	305,0	80	8	19405	19405xx	6x15	87001300	RIV615T11	SE/4/1;	SAE
200	311,0	120	8	16066	16066xx					INCONNU
200	316,0	72	4+4	19858/19859	19858xx					LECINENA
200	335,0	96	8	19700	19700xx	L09	88000700	RIVL09	YK/12/1;	YORK
200	350,0	80	4+4	19908/19909	1990803	L10	88000800	RIVL10	RW/21/1; RW/22/1;	ROR
200	355,0	80	4+4	19892/19893	1989208	8x18	85000700	RIV818	SJ/26/1; SJ/27/1;	SAE SAF
200	360,0	72	4+4	19902/19903	1990210	8x15	85000600	RIV815	BC/100/1; BC/101/1;	BPW
200	360,0	96	4+4	19718/19719	1971802	5x14,2	85000500	RIV515TF	BC/120/1; BC/121/1;	SMB C5
200	364,0	56	4+4	19505/19112	1950505	8x15	85000600	RIV815	MB/120/1; MB/121/1;	MERCEDES
200	367,0	64	4+4	19490/19491	1949005	8x15	86002700	RIV815	SJ/34/1; SJ/35/1;	SAE SAF

Les garnitures de frein avec suffixes xx sont livrables sous 48-72 heures

Brake linings xx suffixes are available in 48-72 hours

RECHERCHE GARNITURES DE FREIN PAR DIMENSIONS BRAKE LINING RESEARCH BY SIZE

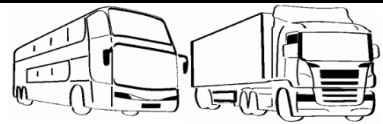
Larg/ Width	Ø Tamb/ Drum	Nbr rivet/s et	Nbr	VVA	REF	Rivet Type	Rivet Textar	Rivet GIL	BFMC	
200	381,0	96	8	19542	1954201	L09	88000700	RIVL09	RW/25/1;	LEYLAND VOLVO
200	393,7	72	8	19685	19685xx	L10	88000800	RIVL10	GG/179/1;	DENNIS LEYLAND
200	400,0	80	4+4	19166/19167	1916602	8x18	85000700	RIV818	BC/91/1; BC/90/1;	KAESSBOHRER
200	406,0	72	4+4	16070/16072	16070xx					INCONNU
200	410,0	96	8	19754	1975402	10x18	87002000	RIV1018	FI/115/1;	PERROT
200	410,0	96	8	19786	1978610	10x18	87002000	RIV1018	PB/3/1;	IVECO VANHOOL
200	410,0	96	4+2+2	19553/19716/19717	1971612	8x15	87001500	RIV815	RW/29/1; RW/32/1; RW/33/1	IVECO ROCKWELL SIMPLEX
200	410,0	96	4+4	19116/19119	1911602	8x15	87001500	RIV815	RW/38/1; RW/39/1;	IVECO ROCKWELL DUPLEX
200	410,0	96	6+2	19786/19823	1978611	10x18	87002000	RIV1018	PB/3/1; PB/4/1;	IVECO VANHOOL
200	410,0	96	6+2	19553/19554	1955301	8x15	87001500	RIV815	RW/29/1; RW/29/2;	IVECO ROCKWELL SIMPLEX
200	410,0	104	4+4	19880/19882	19880xx	6x15	87001300	RIV615T11		PEGASO
200	410,0	112	8	19343	1934302	8x16	85002200	RIV816	PB/24/2;	IVECO PERROT
200	410,0	128	8	18014	18014xx	L11	88000900	RIVL11	RW/27/1;	ASTRA
200	414,0	64	8	19974	19974xx	8x18	85000700	RIV818		RT
200	414,0	92	2+2	19406/19407	1940600929	6x18	86002400	RIV618	LF/102/1; LF/103/1;	COLAERT
200	420,0	64	8	19338	19338xx	8x15	85000600	RIV815	FT/5/1;	CODER
200	420,0	64	4+4	19477/19478	1947706	8x15	85000600	RIV815	SJ/30/1; SJ/31/1;	SAE SAF
200	420,0	80	8	19094	1909437	8x15	85000600	RIV815	BC/97/1;	BPW
200	420,0	80	8	19192	1919201	8x15	85000600	RIV815		BPW
200	420,0	80	8	19644	19644xx	8x18	85000700	RIV818		GORICKA
200	420,0	80	4+4	19251/19252	19251xx	8x15	85000600	RIV815	BL/36/1; BL/35/1;	MOL
200	420,0	128	4+4	19891/19890	1989002	L10	88000800	RIVL10	DF/33/1; DF/32/1;	BOVA DAF
200	500,0	64	8	19730	19730xx					PERROT
202	410,0	96	6+2	19091/19098	1909102	8x16	85002200	RIV816	PB/42/1; PB/42/2;	IVECO
203	311,0	96	4+4	19862/19863	1986201	5x14,2	85000500	RIV515TF	FU/18/2; FU/17/2;	SMB C3
203	393,7	68	2+2	19066/19067	19066xx	L12	88000900	RIVL11	LE/60/1; LE/60/2;	LEYLAND
203	393,7	72	4	19371	19371xx	L09	88000700	RIVL09	GG/142/1;	DODGE ERF LEYLAND
203	393,7	84	4+4	19562/19563	1956202	L11	88000900	RIVL11	VL/76/2; VL/77/1;	VOLVO
203	393,7	96	8	19745	19745xx	L10	88000800	RIVL10	CS/64/1;	DENNIS ERF
203	393,7	96	8	19922	19922xx	L09	88000700	RIVL09	CS/67/2;	DENNIS ERF

Les garnitures de frein avec suffixes xx sont livrables sous 48-72 heures

Brake linings xx suffixes are available in 48-72 hours

RECHERCHE GARNITURES DE FREIN PAR DIMENSIONS BRAKE LINING RESEARCH BY SIZE

Larg/ Width	Ø Tamb/ Drum	Nbr rivet/s et	Nbr	VVA	REF	Rivet Type	Rivet Textar	Rivet GIL	BFMC	
203	393,7	128	8	19921	1992101	L09	88000700	RIVL09	CW/12/1;	FORD LEYLAND
203	406,0	96	8	19995	19995xx	L09	88000700	RIVL09	NN/61/1;	HINO
203	412,8	64	4	19932	1993201	S38	85002100	RIVS38	SV/41/2;	SCANIA
203	412,8	96	8	19393	1939302	6,3x18	85000400	RIV6.318	SV/27/1;	SCANIA
203	419,0	96	4+4	19365/19366	1936605	L10	88000800	RIVL10	RW/2/3; RW/1/3;	ROR
203	419,0	144	4+4	19617/19911	1961705	L10	88000800	RIVL10	DF/31/1;	DAF VANHOOL
203	419,1	96	4+4	19365/19366	1936515	5x14,2	85000500	RIV515TF	RW/1/1; RW/2/1;	ROR
203	419,1	128	4+4	19557/19606	1955713	5x14,2	85000500	RIV515TF	FT/6/1; FT/7/1;	SMB C1
203	419,1	160	4+4	19617/19618	19618xx	L10	88000800	RIVL10	DF/31/1; DF/30/1;	DAF
209	393,7	128	4+4	19461/19462	1946101	L09	88000700	RIVL09	YK/9/2; YK/8/2;	MOL YORK
210	311,0	128	4+4	19826/19827	19826xx	L10	88000800	RIVL10	YK/10/1; YK/11/1;	YORK
210	410,0	96	4+4	18020	18020xx	6x18	86002400	RIV618	SV/47/1; SV/48/1;	SISU
218	419,1	96	4+4	19983/19984	1998301	L09	88000700	RIVL09		ROR
219	410,0	72	4+4	19581/19582	1958101	8x18	85000700	RIV818	MB/77/1; MB/76/1;	MAN MERCEDES
219	410,0	72	4+4	19581/19707	1970701	8x18	85000700	RIV818	MB/77/2; MB/76/2;	BOVA MAN MERCEDES NEOPLAN
219	410,0	96	4+4	19743/19755	1974302	10x18	87002000	RIV1018	PB/21/1; PB/20/1;	KAESSBOHRER NEOPLAN VANHOOL
219	419,1	96	4+4	19369/19370	1936912	L10	88000800	RIVL10	FU/5/4; FU/4/4;	ROR
219	420,0	96	8	19591	1959111	8x15	85000600	RIV815	BC/81/1;	BPW
220	370,0	80	8	19466	19466xx	8x18	85000700	RIV818	MB/58/3;	MERCEDES
220	410,0	96	4+2+2	19848/847/699	1969905	10x18	87002000	RIV1018	PB/19/1; PB/18/1; PB/18/2	KAESSBOHRER
220	410,0	96	4+4	19712/19755	1971201	10x18	87002000	RIV1018	PB/32/1; PB/31/1;	KAESSBOHRER IVECO NEOPLAN VANHOOL
220	410,0	96	4+4	19114/19115	19114xx	10x18	87002000	RIV1018	PB/38/1; PB/39/1;	VAN HOOL (mach./shoe Acier/Steel)
220	410,0	96	4+4	19114/19115	19114xx	10x18	87002000	RIV1018	PB/38/1; PB/39/1;	VAN HOOL (mach./shoe fonte/cast)
220	410,0	112	6+2	19824/19838	1982410	10x18	87002000	RIV1018		IVECO PERROT
220	414,0	64	8	19187	1918702	8x18	85000700	RIV818	RN/104/1;	RT
220	420,0	80	8	19825	19825xx	8x18	85000700	RIV818	BC/99/1;	BPW
223	410,0	64	8	19496	1949602	8x18	85000700	RIV818	MP/36/2;	MAN MERCEDES
223	410,0	112	8	19068	1906802	L11	88000900	RIVL11	VL/89/2; (VL/89/1);	DENNIS RENAULT TRUCKS VOLVO
230	393,7	96	8	19975/19976	19975xx	L11	88000900	RIVL11	VL/100/1; VL/101/1;	VOLVO
240	393,7	84	4+4	19885/19886	1988501	L11	88000900	RIVL11	VL/83/1; VL/84/2;	VOLVO

Les garnitures de frein avec suffixes xx sont livrables sous 48-72 heures

Brake linings xx suffixes are available in 48-72 hours

RECHERCHE GARNITURES DE FREIN PAR DIMENSIONS BRAKE LINING RESEARCH BY SIZE

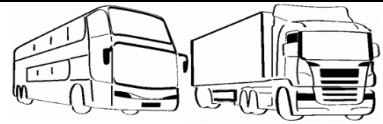
Larg/ Width	Ø Tamb/ Drum	Nbr rivet/s et	Nbr	WVA	REF	Rivet Type	Rivet Textar	Rivet GIL	BFMC	
240	420,0	128	4+4	19914/19915	1991403	L10	88000800	RIVL10	DF/38/1; DF/39/1;	DAF
240	420,0	128	4+4	19069/19077	1906901	6,5x17,6	85001700	RIV6.517	DF/50/1; DF/51/1;	DAF
254	393,7	84	4+4	19799/19800	1979901	L11	88000900	RIVL11	VL/82/1; VL/81/2;	VOLVO
254	412,8	64	4	19933	1993301	S38	85002100	RIVS38	SV/42/2;	SCANIA
254	412,8	96	8	19647	1964702	6,3x18	85000400	RIV6.318	SV/34/1;	NEOPLAN SCANIA



Les garnitures de frein avec suffixes xx sont livrables sous 48-72 heures
 Brake linings xx suffixes are available in 48-72 hours

DIMENSIONS DES RIVETS DIMENSIONS RIVETS

Textar	GIL	Ø	Long.	head	angle	Matiere	Designation	type	Rep.
85000400	RIV6.318	6,3	18,0	12,0	180°	Laiton/Brass	Special Scania old ST		3
85000500	RIV515TF	5,0	15,5	12,0	150°	Acier zingué	Special SMB ST		5
85000600	RIV815	8,0	15,0	15,5	180°	Acier zingué	Renforced Mercedes	7338 C2	2
85000700	RIV818	8,0	18,0	15,5	180°	Acier zingué	Renforced Mercedes	7338 C2	2
85001400	RIV10-10	6,3	16,5	12,0	125°	Acier zingué	Tubulaire Iveco 19384	10.10	1
85001700	RIV6.517	6,5	17,6	14,0	180°	Acier zingué	Semi-tubulaire DAF		3
85002100	RIVS38	6,6	18,0	12,0	180°	Laiton/Brass	ST Scania new	S38	3
85002200	RIV816	8,0	16,0	16,0	180°	Acier zingué	ST Iveco		3
86000700	RIV408	4,0	8,0	7,5	180°	Laiton/Brass	Semi-tubulaire	7338 B	3
86000800	RIV410	4,0	10,0	7,5	180°	Laiton/Brass	Semi-tubulaire	7338 B	3
86001500	RIV510	5,0	10,0	9,5	180°	Laiton/Brass	Semi-tubulaire	7338 B	3
86001600	RIV512	5,0	12,0	11,0	180°	Laiton/Brass	Semi-tubulaire	7338 B	3
	RIV514	5,0	14,0	12,0	180°	Acier zingué	Semi-tubulaire	7338 B	3
86001700	RIV515	5,0	15,0	11,0	180°	Laiton/Brass	Semi-tubulaire	7338 B	3
	RIV516	5,0	16,0	12,0	180°	Laiton/Brass	Semi-tubulaire	7338 B	3
86002100	RIV610	6,0	10,0	11,0	180°	Laiton/Brass	Semi-tubulaire	7338 B	3
86002200	RIV612	6,0	12,0	11,0	180°	Laiton/Brass	Semi-tubulaire	7338 B	3
86002300	RIV615	6,0	15,0	12,0	180°	Laiton/Brass	Semi-tubulaire	7338 B	3
86002400	RIV618	6,0	18,0	12,0	180°	Laiton/Brass	Semi-tubulaire	7338 B	3
86002700		8,0	15,0	15,5	180°	Acier zingué	Semi-tubulaire	7338 B	3
86002701		8,0	15,0	15,5	180°	Cuivre/Copper	Semi-tubulaire	7338 B	3
86002800	RIV818ST	8,0	18,0	15,5	180°	Acier zingué	Semi-tubulaire	7338 B	3
86002801		8,0	18,0	15,5	180°	Cuivre/Copper	Semi-tubulaire	7338 B	3
86002900		8,0	20,0	15,5	180°	Cuivre/Copper	Semi-tubulaire	7338 B	3
86003200		10,0	18,0	19,0	180°	Cuivre/Copper	Semi-tubulaire	7338 B	3
87000400		4,0	8,0	7,5	180°	Cuivre/Copper	Tubulaire	7338 C	4
87000500		4,0	10,0	7,5	180°	Cuivre/Copper	Tubulaire	7338 C	4
	RIV506TP9.5	5,0	6,0	9,5	180°	Acier zingué	Tubulaire	7338 C	4
	RIV606TP11.5	6,0	6,0	11,5	180°	Acier zingué	Tubulaire	7338 C	4
87001200		6,0	12,0	11,0	180°	Acier zingué	Tubulaire	7338 C	4
87001300	RIV615T11	6,0	15,0	11,0	180°	Acier zingué	Tubulaire	7338 C	4
	RIV812	8,0	12,0	15,5	180°	Acier zingué	Tubulaire	7338 C	4
87001500	RIV815	8,0	15,0	15,5	180°	Acier zingué	Tubulaire	7338 C	4
87001600	RIV818	8,0	18,0	15,5	180°	Acier zingué	Tubulaire	7338 C	4
	RIV820	8,0	20,0	15,5	180°	Acier zingué	Tubulaire	7338 C	4
87002000	RIV1018	10,0	18,0	19,0	180°	Acier zingué	Tubulaire	7338 C	4
	RIV1020	10,0	20,0	19,0	180°	Acier zingué	Tubulaire	7338 C	4
88000700	RIVL09	6,4	14,3	12,0	150°	Acier zingué	Semi-tubulaire L09	BS3575	5
88000800	RIVL10	6,4	15,9	12,0	150°	Acier zingué	Semi-tubulaire L10	BS3575	5
88000900	RIVL11	6,4	17,5	12,0	150°	Acier zingué	Semi-tubulaire L11	BS3575	5
	RIVL12	6,4	19,1	12,0	150°	Acier zingué	Semi-tubulaire L12	BS3575	5

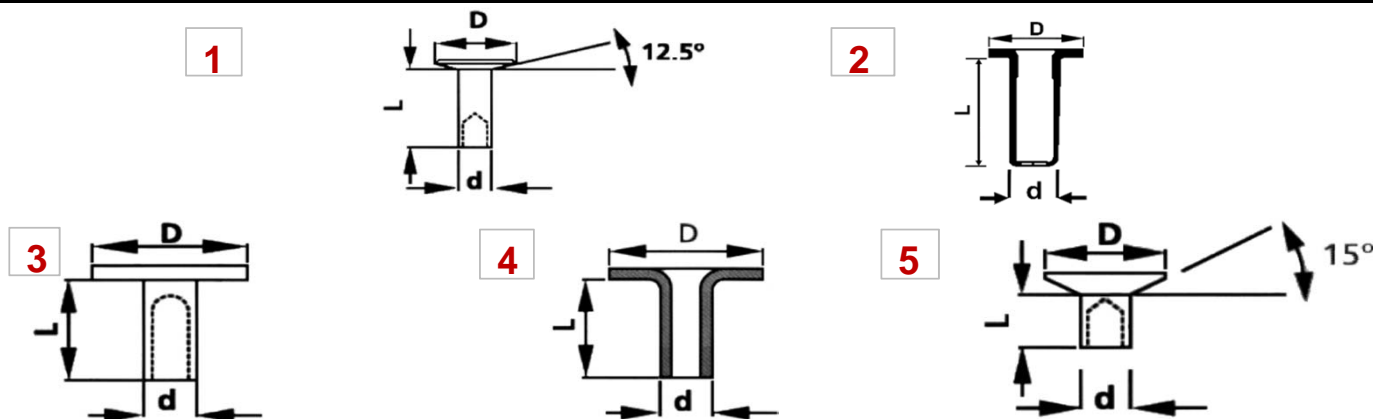

**LISTE APPLICATIVE DES TEMOINS D'USURE
WEAR INDICATOR LIST**

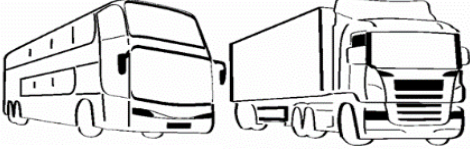
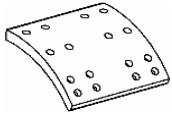
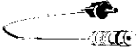
	Th.	WVA		
IVECO	00	19091/19098	1909102	98032100
IVECO	00	19099/19100	1909902	98032100
IVECO	00	19109/19110	1910902	KTU011
IVECO	10	19109/19110	1910903	KTU011
IVECO	00	19116/19119	1911602	KTU011
IVECO	00	19342	1934202	98032100
IVECO	00	19343	1934302	98032100
IVECO	10	19343	1934304	98032100
IVECO MERITOR	00	19384	1938414	KTU012
IVECO PERROT	00	19503	1950308	KTU010
IVECO MERITOR	00	19503	1950308	KTU013
IVECO	00	19553/19554	1955301	98032200
IVECO	10	19553/19554	19553xx	98032200
IVECO	20	19553/19554	19553xx	98032200
IVECO	00	19555/19556	1955502	98032200
IVECO	10	19555/19556	19555xx	98032200
IVECO	00	19556/714/715	1971401	98032200
IVECO	10	19556/714/715	1971403	98032200
IVECO	10	19553/716/717	1971602	98032200
IVECO	00	19553/19716/19717	1971612	98032200
MAN	00	17238	1723802	98023500
MAN	10	17238	1723804	98023500
MAN	20	17238	1723806	98023600
MAN	00	19495	1949502	98023500
MAN	13	19495	1949504	98023500
MAN	21	19495	1949505	98023600
MAN	00	19496	1949602	98023500
MAN	10	19496	1949604	98023500
MAN	20	19496	1949605	98023600
MAN	00	19713	1971301	98023500
MAN	10	19713	1971302	98023500
MERCEDES	00	11019/11025/11582	1101901	98016800
MERCEDES	00	13020/13532	1302001	98016800
MERCEDES	10	13020/13532	1302002	98016800
MERCEDES	00	15030/15742	1503002	98016800
MERCEDES	10	15030/15742	1503003	98016800
MERCEDES	00	15059/15869	1505901	98016900

**LISTE APPLICATIVE DES TEMOINS D'USURE
WEAR INDICATOR LIST**

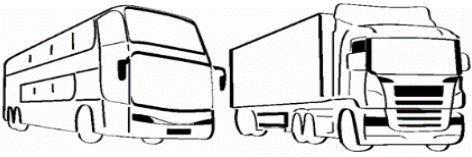
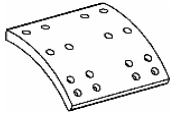
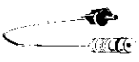
	Th.	WVA		
MERCEDES	10	15059/15869	15059xx	98016900
MERCEDES	00	15162	1516203	98017002
MERCEDES	10	15162	15162xx	98017002
MERCEDES	00	17238	1723802	98017002
MERCEDES	10	17238	1723804	98017002
MERCEDES	20	17238	17238xx	98017102
MERCEDES	00	17278	1727806	98017002
MERCEDES	10	17278	1727807	98017002
MERCEDES	00	17280	1728006	98017002
MERCEDES	10	17280	1728007	98017002
MERCEDES	20	17280	17280xx	98017102
MERCEDES	00	17287	1728705	98017002
MERCEDES	10	17287	1728706	98017002
MERCEDES	00	17290/17950	1729006	98017002
MERCEDES	10	17290/17950	1729007	98017002
MERCEDES	20	17949/17950	17290xx	98017102
MERCEDES	00	17350/19973	1735003	98016900
MERCEDES	10	17350	1735004	98016900
MERCEDES	00	17351/17975	1735103	98016900
MERCEDES	10	17351/17975	1735104	98016900
MERCEDES	00	19494	1949402	98017002
MERCEDES	13	19494	1949404	98017002
MERCEDES	21	19494	1949405	98017102
MERCEDES	00	19495	1949502	98017002
MERCEDES	13	19495	1949504	98017002
MERCEDES	21	19495	1949505	98017102
MERCEDES	00	19496	1949602	98017002
MERCEDES	10	19496	1949604	98017002
MERCEDES	20	19496	1949605	98017102
MERCEDES	00	19505/19112	1950505	98017002
MERCEDES	10	19505/19112	1950506	98017002
MERCEDES	00	19506/19845	1950607	98017002
MERCEDES	10	19506/19845	1950608	98017002
MERCEDES	00	19579/19706	1970601	98017002
MERCEDES	10	19579/19706	1970618	98017002
MERCEDES	20	19579/19706	1970619	98017102
MERCEDES	00	19581/19707	1970701	98017002

LISTE APPLICATIVE DES TEMOINS D'USURE
WEAR INDICATOR LIST

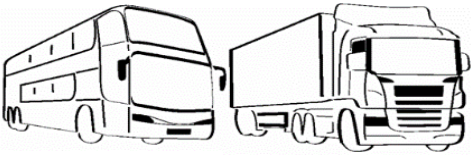
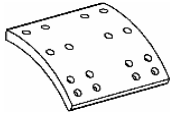
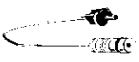
	Th.	WVA		
MERCEDES	10	19581/19707	1970702	98017002
MERCEDES	20	19581/19707	1970720	98017102



KIT COMPLET MACHOIRES GARNIES + KIT ACCESSOIRES
COMPLETE BRAKE SHOES KIT + FITTING KIT



FREIN/ BRAKE	REF / PN	QTY/ ESSIEU /AXLE	DESIGNATION DAF
420x200	1906380	1	KIT MACHOIRES GARNIES CO +ACC/LINED BRAKE SHOES KIT + FITTING KIT

**KIT COMPLET MACHOIRES GARNIES + KIT ACCESSOIRES
COMPLETE BRAKE SHOES KIT + FITTING KIT**



FREIN/B RAKE	REF / PN	QTY ESSIEU /AXLE	DESIGNATION DAF IRISBUS KAROSA RENAULT TRUCKS VOLVO FREIN Z CAME
410X125	1799280	1	KIT MACHOIRES GARNIES CO +ACC / LINED BRAKE SHOES KIT + FITTING KIT
410X150	1994180	1	KIT MACHOIRES GARNIES CO +ACC / LINED BRAKE SHOES KIT + FITTING KIT
410X175	1909080	1	KIT MACHOIRES GARNIES CO +ACC / LINED BRAKE SHOES KIT + FITTING KIT
410X200	1907180	1	KIT MACHOIRES GARNIES CO +ACC / LINED BRAKE SHOES KIT + FITTING KIT
410X225	1906880	1	KIT MACHOIRES GARNIES CO +ACC / LINED BRAKE SHOES KIT + FITTING KIT

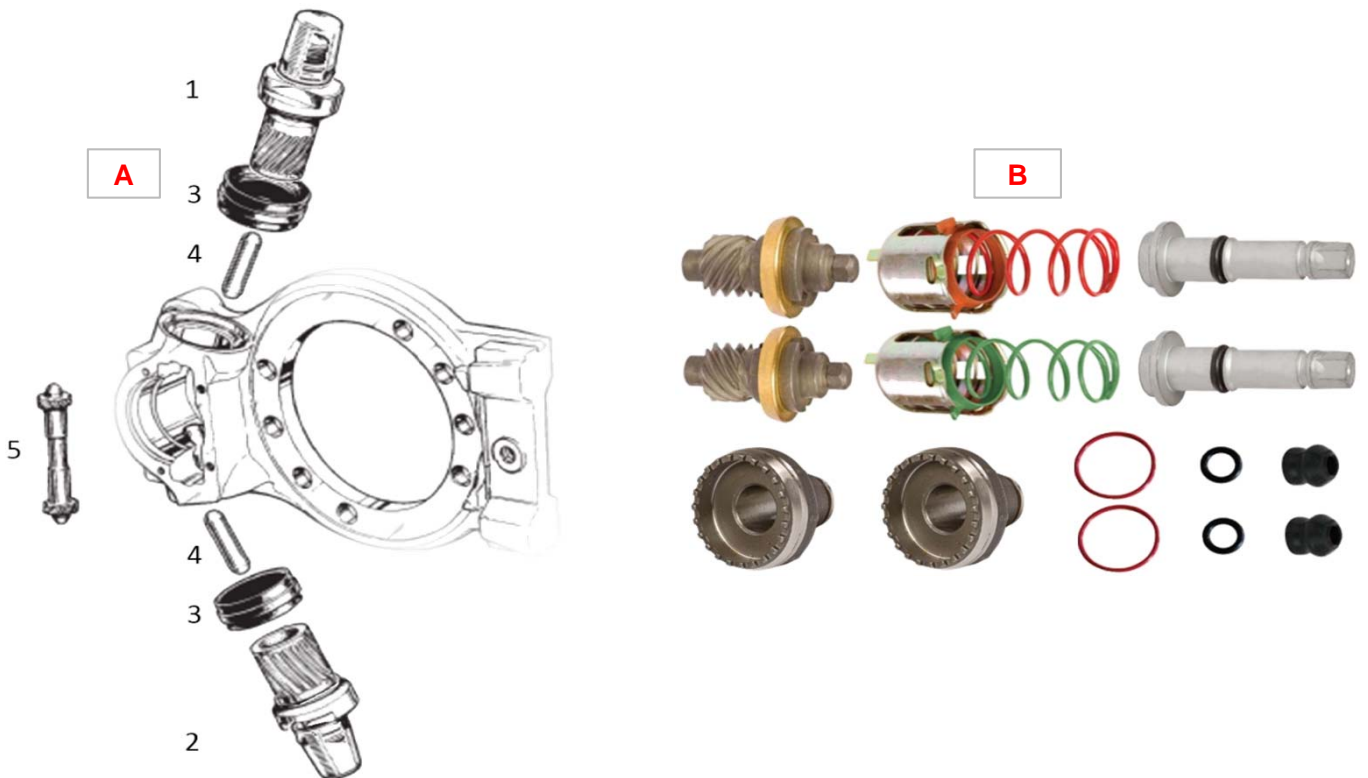

FREIN /BRAKE	REP	REF / PN	QTY ESSIEU /AXLE	DESIGNATION DAF IRISBUS KAROSA RENAULT TRUCKS VOLVO FREIN Z CAME
Z CAME	A	CAC002	2	KIT COMPLET REGLAGE CAME Z / ADJUSTER FITTING KIT
			QTY KIT	CONTIENT / CONTENT
	1	AC0006	1	KIT REGLAGE GAUCHE AUTOMATIQUE/ ADJUSTER KIT LEFT
	2	AC0005	1	KIT REGLAGE DROIT AUTOMATIQUE/ ADJUSTER KIT RIGHT
	3	AC0014	2	CACHE-POUSSIERE / DIRT EXCLUDER
	4	AC0007	2	JAMBE/ STRUT
	5	AC0001	1	KIT D'AXE TRANSVERSAL/ CROSS SHAFT KIT
Z CAME	B	CAC003	1	KIT COMPLET REGLAGE AXIAL / FITTING KIT

KIT COMPLET MACHOIRES GARNIES + KIT ACCESSOIRES
COMPLETE BRAKE SHOES KIT + FITTING KIT

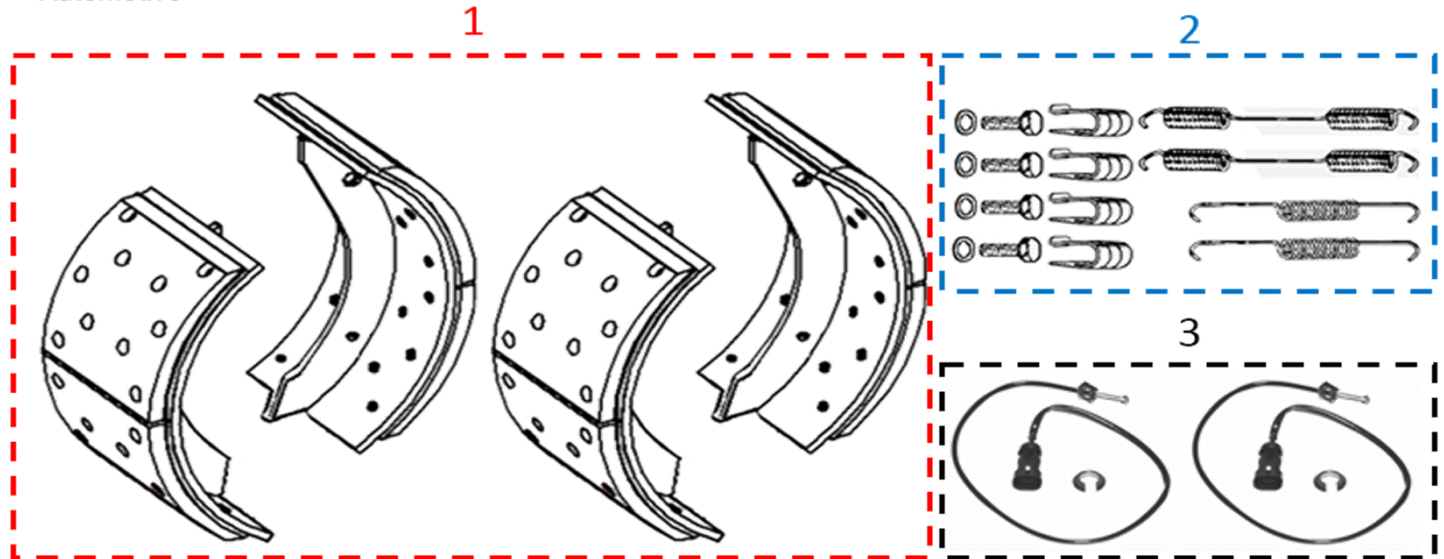

FREIN /BRAKE	REP	REF / PN	QTY ESSIEU /AXLE	DESIGNATION IVECO PERROT SIMPLEX
360x170	1.2.3	1950380	1	KIT MACHOIRES GARNIES CO +ACC / LINED BRAKE SHOES KIT + FITTING KIT
360x170	1	1950378	1	KIT MACHOIRES GARNIES CO / LINED BRAKE SHOES KIT
360x170	2	KRES007	1	KIT RESSORTS ET MAINTIENS / SPRING KIT AND HOLD DOWN CLIP
360x170	3	KTU010	1	KIT TEMOINS D'USURE/WEAR INDICATOR KIT
410x182	1.2.3	1909980	1	KIT MACHOIRES GARNIES CO +ACC / LINED BRAKE SHOES KIT + FITTING KIT
410x182	1	1909978	1	KIT MACHOIRES GARNIES CO / LINED BRAKE SHOES KIT
410x182	2	KRES008	1	KIT RESSORTS ET MAINTIENS / SPRING KIT AND HOLD DOWN CLIP
410x182	3	98032100	2	TEMOIN D'USURE/WEAR INDICATOR
410x202	1.2.3	1909180	1	KIT MACHOIRES GARNIES CO +ACC / LINED BRAKE SHOES KIT + FITTING KIT
410x202	1	1909178	1	KIT MACHOIRES GARNIES CO / LINED BRAKE SHOES KIT
410x202	2	KRES008	1	KIT RESSORTS ET MAINTIENS / SPRING KIT AND HOLD DOWN CLIP
410x202	3	98032100	2	TEMOIN D'USURE/WEAR INDICATOR

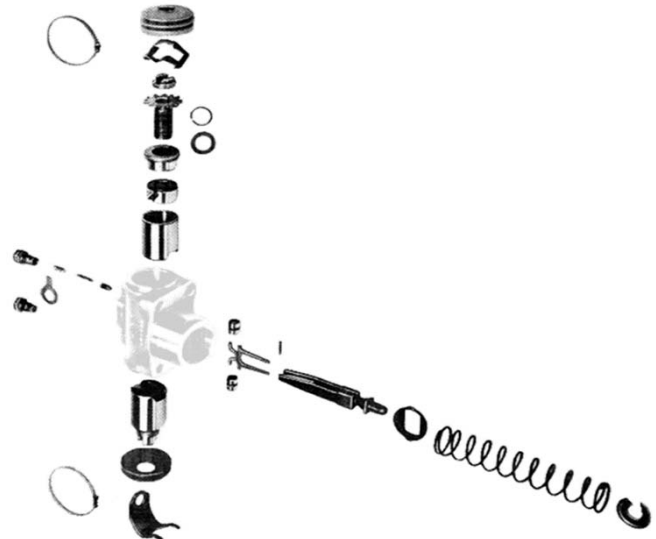
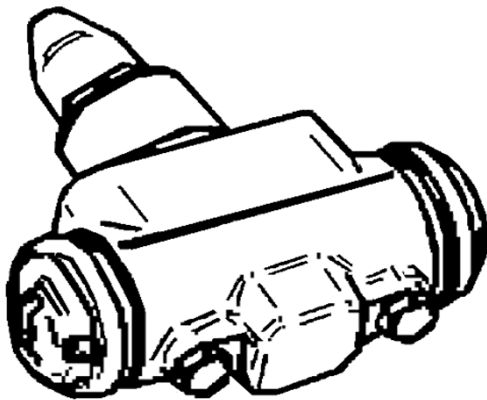

FREIN /BRAKE	REF / PN	QTY ESSIEU /AXLE	DESIGNATION IVECO PERROT
360x170	A ECF001	2	ECARTEUR / WEDGE BRAKE
410x182	B CAC039	2	KIT REGLAGE COIN / FITTING KIT WEDGE
410x202	B CAC039	2	KIT REGLAGE COIN / FITTING KIT WEDGE

KIT COMPLET MACHOIRES GARNIES + KIT ACCESSOIRES
COMPLETE BRAKE SHOES KIT + FITTING KIT

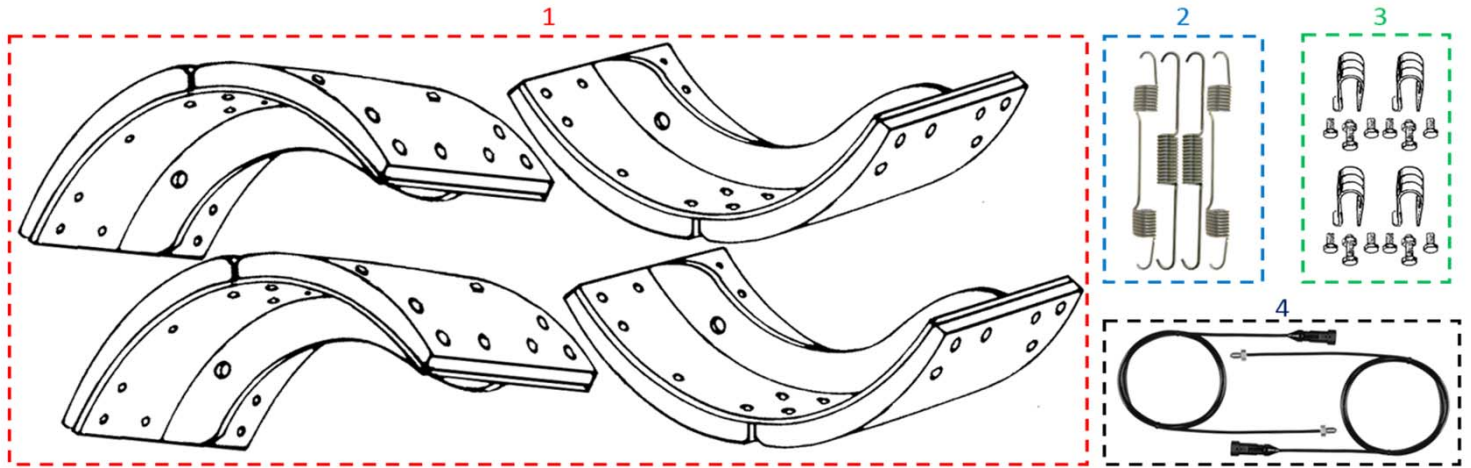

FREIN/ BRAKE	REP	REF / PN	QTY/ ESSIEU /AXLE	DESIGNATION IVECO ROCKWELL STOPMASTER SIMPLEX
360x170	1,2,3,4	1950380M	1	KIT MACHOIRES GARNIES CO +ACC / LINED BRAKE SHOES KIT + FITTING KIT
360x170	1	1950378M	1	KIT MACHOIRES GARNIES CO / LINED BRAKE SHOES KIT
	2	ACK020	1	KIT RESSORTS / SPRING KIT
	3	ACK004	2	KIT MAINTIENS / SPRING HOLD DOWN CLIP KIT
	4	KTU013	1	TEMOIN USURE IVECO ROCKWELL/ WEAR INDICATOR

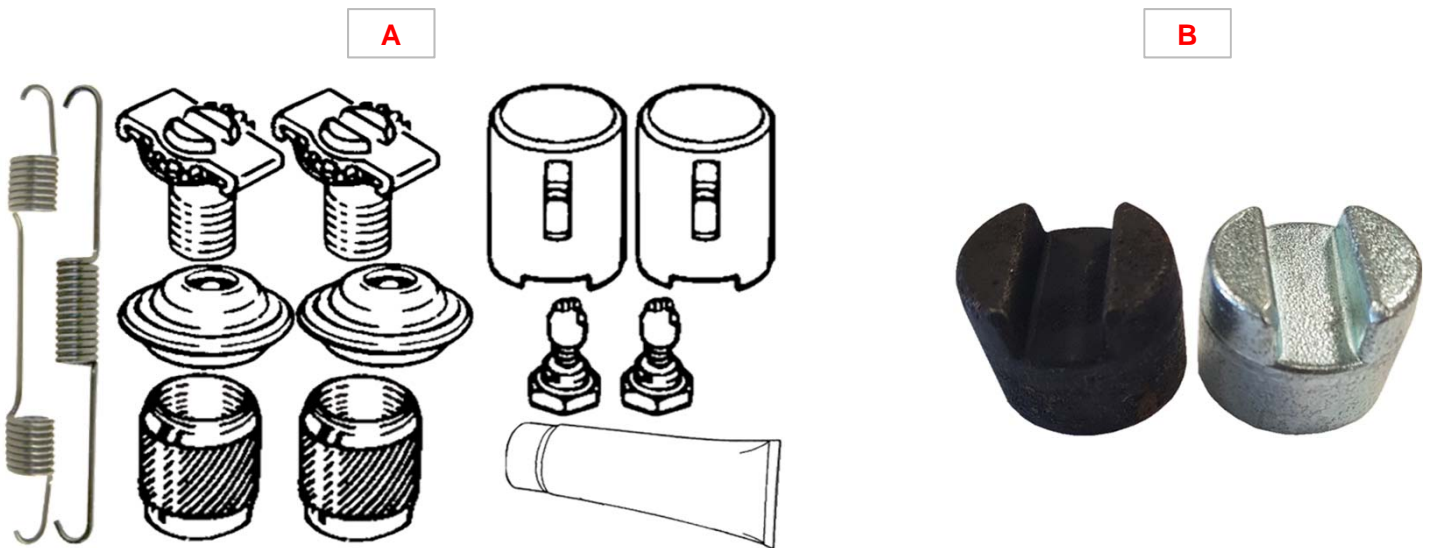

FREIN/ BRAKE	REP	REF / PN	QTY ESSIEU /AXLE	DESIGNATION IVECO ROCKWELL STOPMASTER SIMPLEX
360x170	A	ACK010	2	KIT REGLAGE COIN / FITTING KIT WEDGE
360x170	B	ACK021	2	KIT POINT FIXE / BRAKE SHOES PIN SET

**KIT COMPLET MACHOIRES GARNIES + KIT ACCESSOIRES
COMPLETE BRAKE SHOES KIT + FITTING KIT**

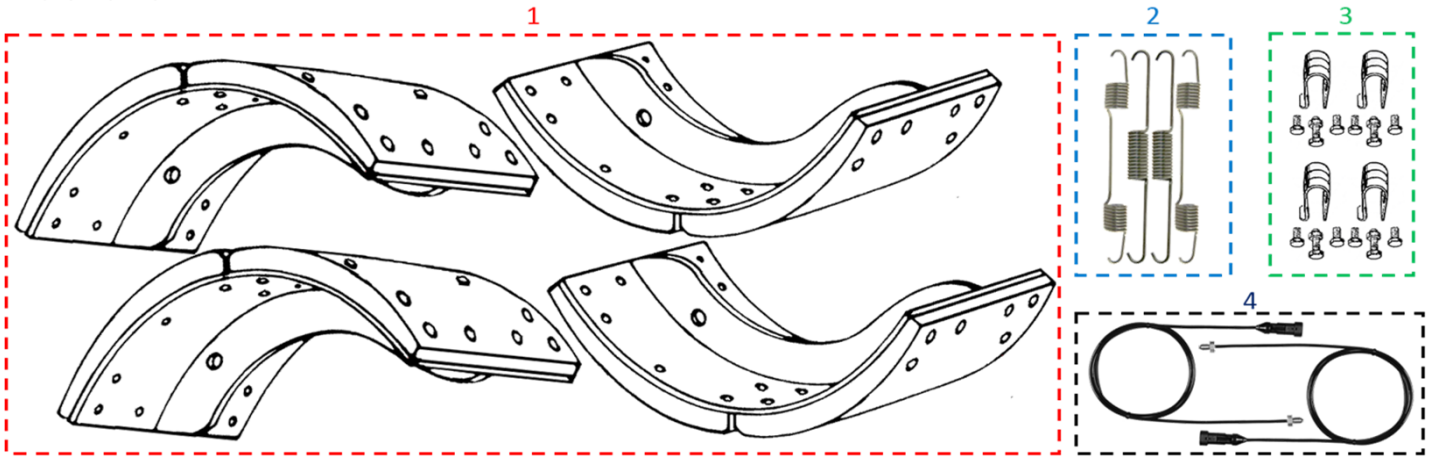

FREIN /BRAKE	REP	REF / PN	QTY/ ESSIEU /AXLE	DESIGNATION IVECO ROCKWELL STOPMASTER SIMPLEX
410x180	1,2,3,4	1971480	1	KIT MACHOIRES GARNIES CO +ACC / LINED BRAKE SHOES KIT + FITTING KIT
410x180	1	1971478	1	KIT MACHOIRES GARNIES CO / LINED BRAKE SHOES KIT
410x200	1,2,3,4	1971680	1	KIT MACHOIRES GARNIES CO +ACC / LINED BRAKE SHOES KIT + FITTING KIT
410x200	1	1971678	1	KIT MACHOIRES GARNIES CO / LINED BRAKE SHOES KIT
	2	KRES010	1	KIT RESSORTS / SPRING KIT
	3	ACK003	2	KIT MAINTIENS / SPRING HOLD DOWN CLIP KIT
	4	98032200	2	TEMOIN USURE IVECO ROCKWELL/ WEAR INDICATOR

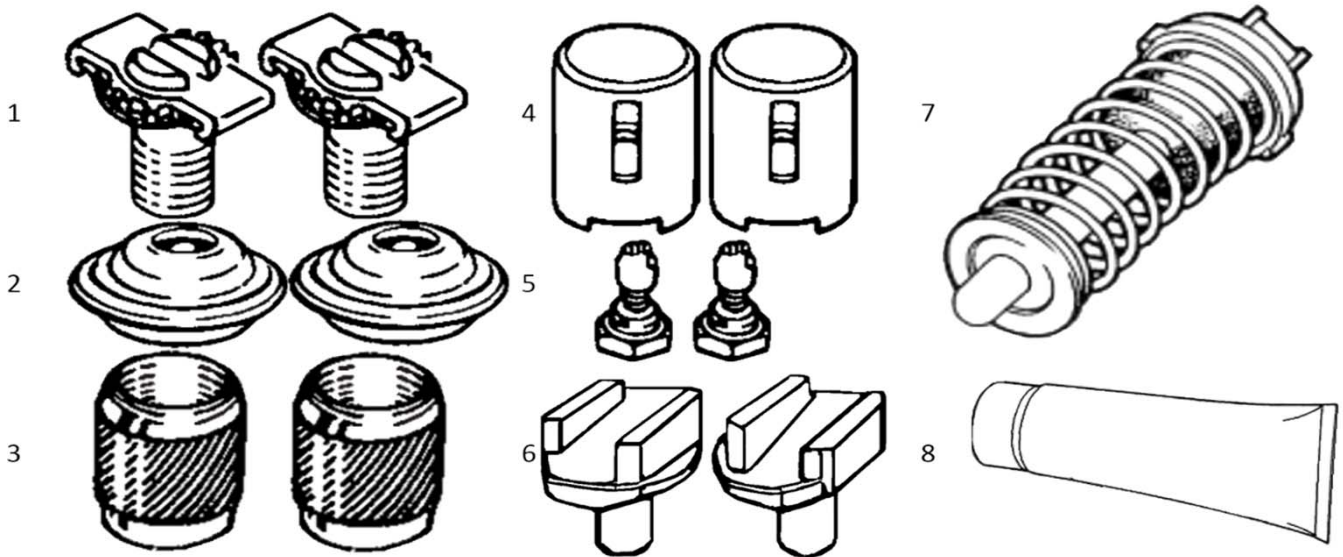

FREIN/B RAKE	REP	REF / PN	QTY /ESSIEU AXLE	DESIGNATION IVECO ROCKWELL STOPMASTER SIMPLEX
	1-10	CAC034	1	KIT REPARATION COIN COMPLET GAUCHE / FITTING KIT WEDGE LEFT
	1-10	CAC035	1	KIT REPARATION COIN COMPLET DROIT / FITTING KIT WEDGE RIGHT
			QTY/ KIT	CONTIENT / CONTENT
	1	AC0023	2	TÊTE DE REGLAGE / ADJUSTING BOLT
	2	AC0029	2	JOINT DE TÊTE DE RÉGLAGE / SEAL - ADJUSTER PLUNGER
	3	AC0034	2	MANCHON DE BOULON DE RÉGLAGE / ADJUSTING BOLT SLEEVE
	4	AC0027	2	AJUSTEMENT DU PLONGEUR D'ECARTEMENT / ADJUSTING PLUNGER
	5	AC0035	2	ENSEMBLE CLIQUET DE GUIDAGE / GUIDE PAWL ASSEMBLY
	6	AC0036	1	KIT PLONGEUR D'ANCRAGE GAUCHE / ANCHOR PLUNGER KIT LEFT
	6	AC0037	1	KIT PLONGEUR D'ANCRAGE DROIT / ANCHOR PLUNGER KIT RIGHT
	7	AC0038	2	COIN ASSEMBLE / WEDGE ASSEMBLY
	8	AC0033	1	GRAISSE / GREASE

**KIT COMPLET MACHOIRES GARNIES + KIT ACCESSOIRES
COMPLETE BRAKE SHOES KIT + FITTING KIT**

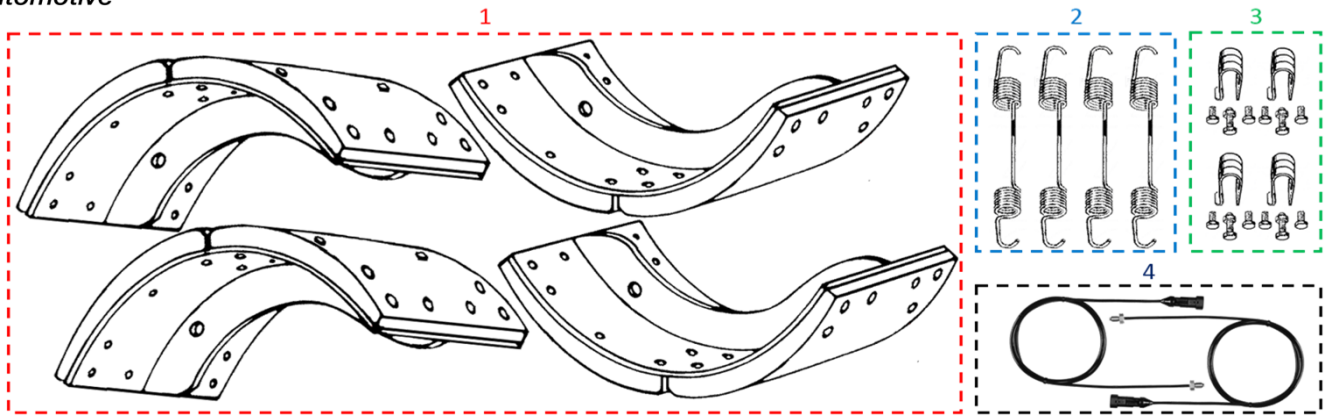

FREIN /BRAKE	REP	REF / PN	QTY/ ESSIEU /AXLE	DESIGNATION IVECO ROCKWELL STOPMASTER DUPLEX
410x180	1,2,3,4	1910980	1	KIT MACHOIRES GARNIES CO +ACC / LINED BRAKE SHOES KIT + FITTING KIT
410x180	1	1910978	1	KIT MACHOIRES GARNIES CO / LINED BRAKE SHOES KIT
410x180	1,2,3,4	1910980NV	1	KIT MACHOIRES GARNIES CO +ACC / LINED BRAKE SHOES KIT + FITTING KIT
410x180	1	1910978NV	1	KIT MACHOIRES GARNIES CO / LINED BRAKE SHOES KIT
410x200	1,2,3,4	1911680	1	KIT MACHOIRES GARNIES CO +ACC / LINED BRAKE SHOES KIT + FITTING KIT
410x200	1	1911678	1	KIT MACHOIRES GARNIES CO / LINED BRAKE SHOES KIT
410x200	1,2,3,4	1911680NV	1	KIT MACHOIRES GARNIES CO +ACC / LINED BRAKE SHOES KIT + FITTING KIT
410x200	1	1911678NV	1	KIT MACHOIRES GARNIES CO / LINED BRAKE SHOES KIT
	2	KRES009	1	KIT RESSORTS / SPRING KIT
	3	ACK003	2	KIT MAINTIENS / SPRING HOLD DOWN CLIP KIT
	4	KTU011	1	TEMOIN USURE IVECO ROCKWELL/ WEAR INDICATOR

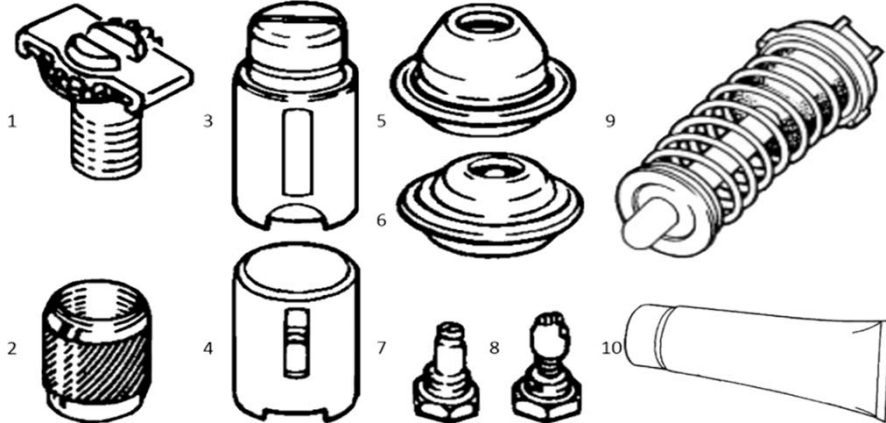

FREIN/B RAKE	REP	REF / PN	QTY /ESSIEU /AXLE	DESIGNATION IVECO ROCKWELL STOPMASTER DUPLEX
			QTY/ KIT	CONTIENT / CONTENT
	1-10	CAC032	2	KIT REPARATION COIN COMPLET GAUCHE / FITTING KIT WEDGE LEFT
	1-10	CAC033	2	KIT REPARATION COIN COMPLET DROIT / FITTING KIT WEDGE RIGHT
	1	AC0023	1	TÊTE DE REGLAGE / ADJUSTING BOLT
	2	AC0024	1	MANCHON DE BOULON DE RÉGLAGE / ADJUSTING BOLT SLEEVE
	3	AC0025	1	PLONGEUR D'ECARTEMENT GAUCHE / ANCHOR PLUNGER LEFT
	3	AC0026	1	PLONGEUR D'ECARTEMENT DROIT / ANCHOR PLUNGER LEFT
	4	AC0027	1	AJUSTEMENT DU PLONGEUR D'ECARTEMENT / ADJUSTING PLUNGER
	5	AC0028	1	JOINT DU PLONGEUR D'ECARTEMENT / SEAL - ANCHOR PLUNGER
	6	AC0029	1	JOINT DE TÊTE DE RÉGLAGE / SEAL - ADJUSTER PLUNGER
	7	AC0030	1	VIS GUIDE / GUIDE SCREW
	8	AC0031	1	ENSEMBLE CLIQUET DE GUIDAGE / GUIDE PAWL ASSEMBLY
	9	AC0032	1	COIN ASSEMBLE / WEDGE ASSEMBLY
	10	AC0033	1	GRAISSE / GREASE

**KIT COMPLET MACHOIRES GARNIES + KIT ACCESSOIRES
COMPLETE BRAKE SHOES KIT + FITTING KIT**



FREIN /BRAKE	REF / PN	QTY / ESSIEU /AXLE	DESIGNATION MAN MERCEDES
410x183	1949578	1	KIT MACHOIRES GARNIES CO / LINED BRAKE SHOES KIT
410x223	1949678	1	KIT MACHOIRES GARNIES CO / LINED BRAKE SHOES KIT



FREIN /BRAKE	REP	REF / PN	QTY /ESSIEU AXLE	DESIGNATION MAN MERCEDES
410x183	A	KRG001	2	KIT REP. GALET MERCEDES/ ROLLER FITTING KIT
410x183	B	APF002	2	KIT REP. AXE POINT FIXE MAN MERCEDES/ BRAKE SHOES PIN SET
410x223	A	KRG001	2	KIT REP. GALET MERCEDES/ ROLLER FITTING KIT
410x223	B	APF002	2	KIT REP. AXE POINT FIXE MAN MERCEDES/ BRAKE SHOES PIN SET

KIT COMPLET MACHOIRES GARNIES + KIT ACCESSOIRES
COMPLETE BRAKE SHOES KIT + FITTING KIT

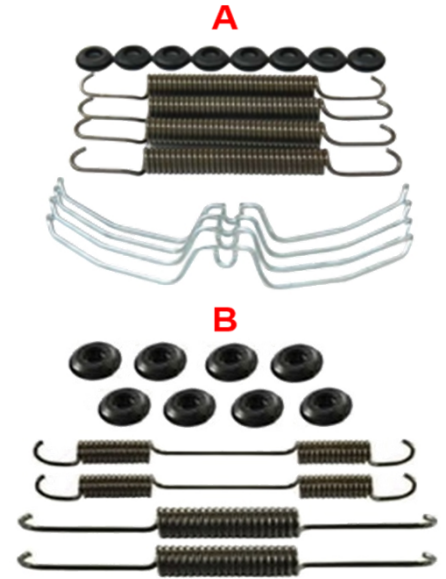
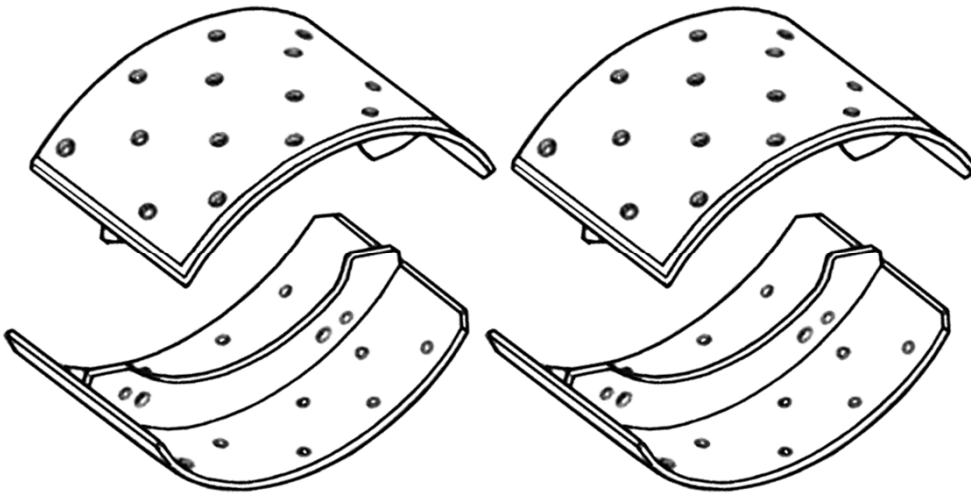

FREIN/B RAKE	REF / PN	QTY ESSIEU /AXLE	DESIGNATION RENAULT TRUCKS (FREIN A COIN / WEDGE BRAKE)
310X125	B 1735280	1	KIT MACHOIRES GARNIES RT MIDLINER CO + ACC / LINED BRAKE SHOES + FITTING KIT
325X150	B 1970980	1	KIT MACHOIRES GARNIES RT MIDLINER CO + ACC / LINED BRAKE SHOES + FITTING KIT
360X170	A 1925580	1	KIT MACHOIRES GARNIES RT MIDLINER CO + ACC / LINED BRAKE SHOES + FITTING KIT

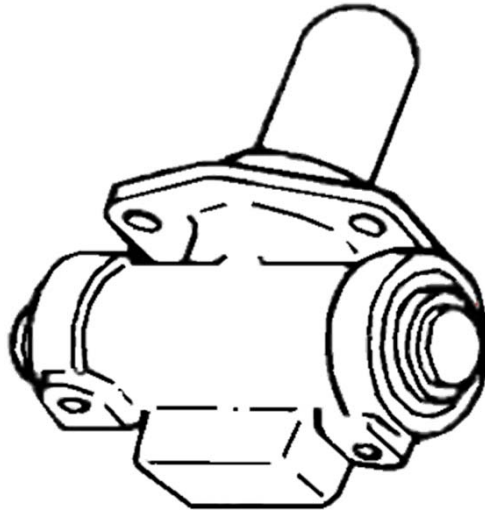

FREIN/B RAKE	REF / PN	QTY ESSIEU /AXLE	DESIGNATION RENAULT TRUCKS (FREIN A COIN / WEDGE BRAKE)
310X125	AB337276	2	ECARTEUR FREIN A COIN / ADJUSTER WEDGE BRAKE
325X150	AB337276	2	ECARTEUR FREIN A COIN / ADJUSTER WEDGE BRAKE
360X170	AB337276	2	ECARTEUR FREIN A COIN / ADJUSTER WEDGE BRAKE

KIT COMPLET MACHOIRES GARNIES + KIT ACCESSOIRES
COMPLETE BRAKE SHOES KIT + FITTING KIT

1

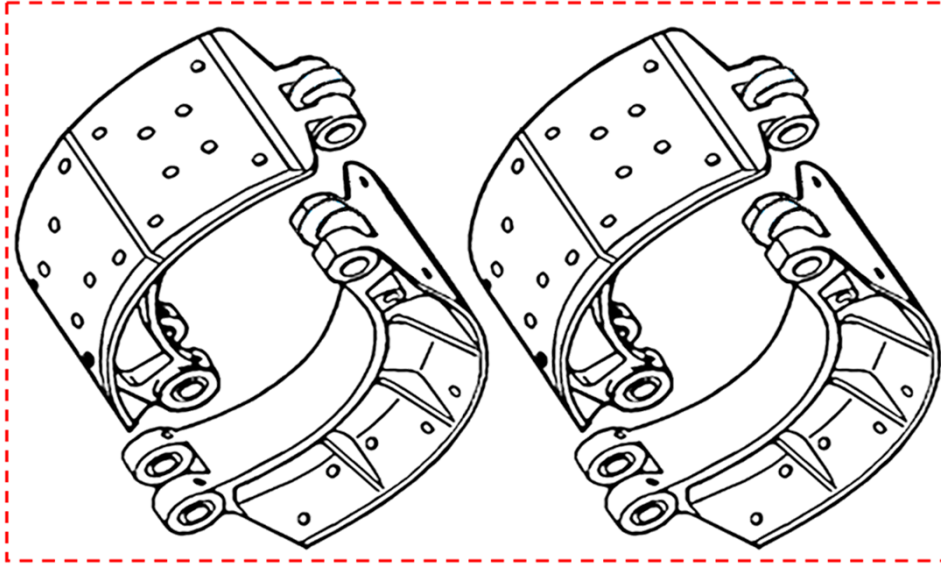

2

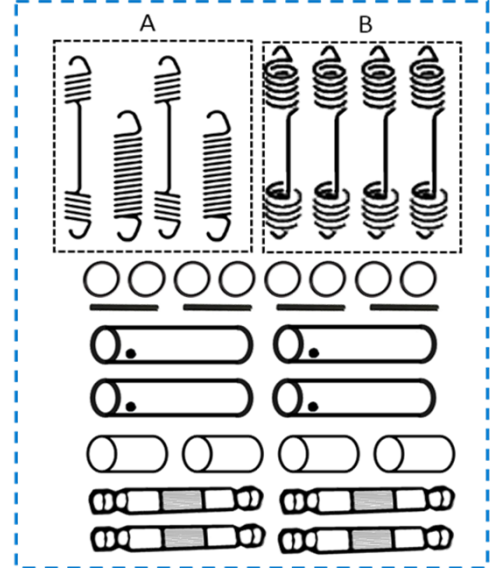

FREIN/B RAKE	REP	REF / PN	QTY ESSIEU /AXLE	DESIGNATION IRISBUS RENAULT TRUCKS (MACHOIRE DE FREIN EN FONTE / CAST BRAKE SHOES)
414X150	1	1993478	1	KIT MACHOIRES GARNIES RT PREMIUM CO/ LINED BRAKE SHOES KIT
414X150	1	1993478K	1	KIT MACHOIRES GARNIES RT KERAX CO/ LINED BRAKE SHOES KIT
414X150	1,2A	1993480	1	KIT MACHOIRES GARNIES RT PREMIUM CO + ACC / LINED BRAKE SHOES + FK
414X150	1,2A	1993480K	1	KIT MACHOIRES GARNIES RT KERAX CO+ACC/ LINED BRAKE SHOES + FK
414X175	1	1993578	1	KIT MACHOIRES GARNIES RT PREMIUM CO/ LINED BRAKE SHOES KIT
414X175	1	1993578K	1	KIT MACHOIRES GARNIES RT KERAX CO/ LINED BRAKE SHOES KIT
414X175	1,2A	1993580	1	KIT MACHOIRES GARNIES RT PREMIUM CO + ACC / LINED BRAKE SHOES + FK
414X175	1,2A	1993580K	1	KIT MACHOIRES GARNIES RT KERAX CO+ACC/ LINED BRAKE SHOES + FK
414X220	1	1918778	1	KIT MACHOIRES GARNIES RT PREMIUM CO/ LINED BRAKE SHOES KIT
414X220	1	1918778K	1	KIT MACHOIRES GARNIES RT KERAX CO/ LINED BRAKE SHOES KIT
414X220	1,2B	1918780	1	KIT MACHOIRES GARNIES RT PREMIUM CO + ACC / LINED BRAKE SHOES + FK
414X220	1,2B	1918780BOM	1	KIT MACHOIRES GARNIES RT PREMIUM CO + ACC / LINED BRAKE SHOES + FK
414X220	1,2A	1918780K	1	KIT MACHOIRES GARNIES RT KERAX CO+ACC/ LINED BRAKE SHOES + FK
414X220	1,2A	1918780KBOM	1	KIT MACHOIRES GARNIES RT KERAX CO+ACC/ LINED BRAKE SHOES + FK

KIT COMPLET MACHOIRES GARNIES + KIT ACCESSOIRES
COMPLETE BRAKE SHOES KIT + FITTING KIT

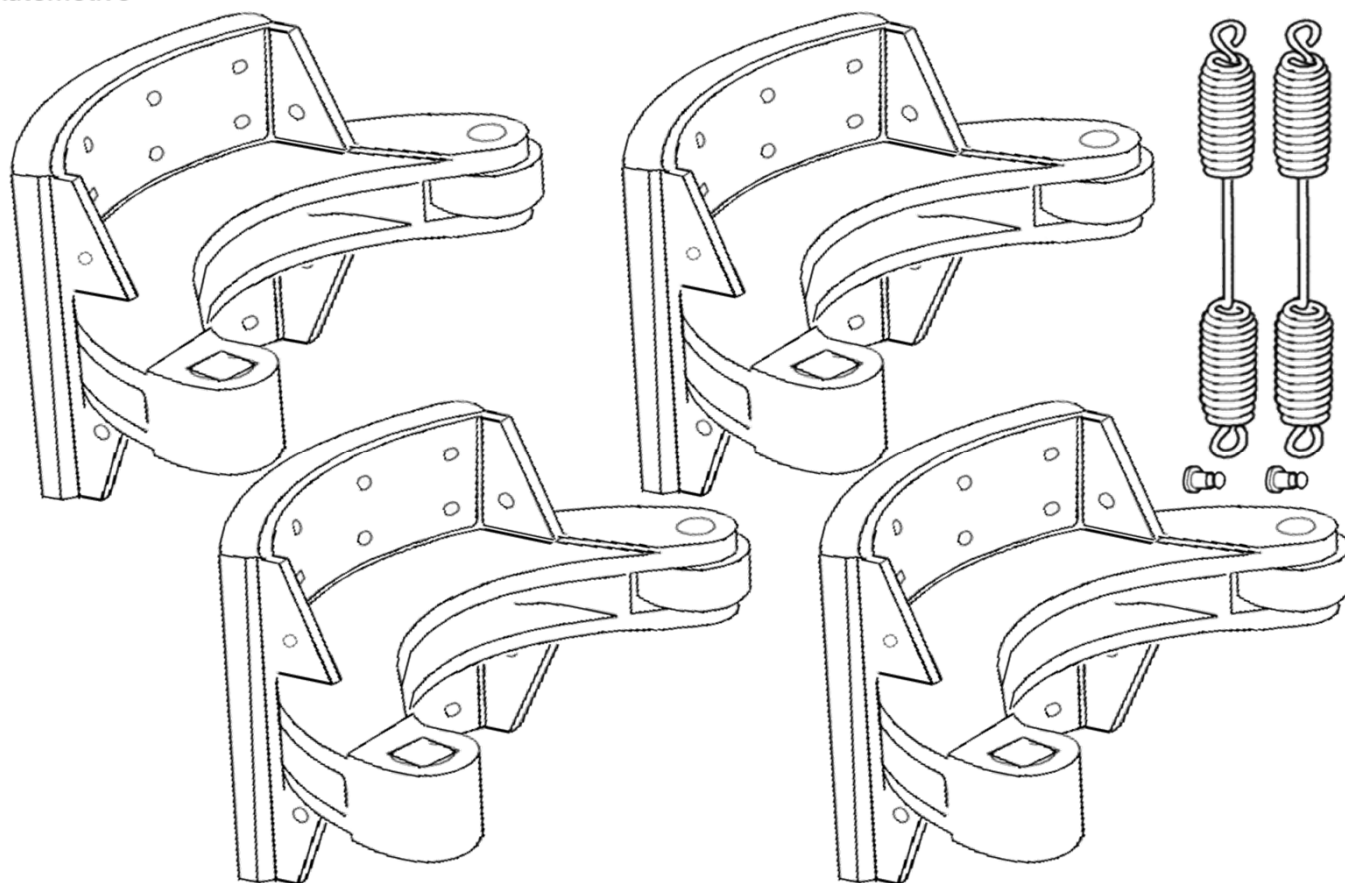

FREIN /BRAKE	REF / PN	QTY ESSIEU /AXLE	DESIGNATION SCANIA (MACHOIRE DE FREIN EN FONTE / CAST BRAKE SHOES)
412,8X203	1993280	1	KIT MACHOIRES GARNIES SCANIA SERIE 4 +ACC/ LINED BRAKE SHOES KIT
412,8X254	1993380	1	KIT MACHOIRES GARNIES SCANIA SERIE 4 CO/ LINED BRAKE SHOES KIT

KIT COMPLET MACHOIRES GARNIES + KIT ACCESSOIRES
COMPLETE BRAKE SHOES KIT + FITTING KIT



FREIN /BRAKE	REF / PN	QTY ESSIEU /AXLE	DESIGNATION BPW (CAME S)
420X180	1903270	1	KIT MACHOIRES GARNIES BPW SN4218 +ACC CO/ LINED BRAKE SHOES KIT
420X200	1909470	1	KIT MACHOIRES GARNIES BPW SN4220 +ACC CO/ LINED BRAKE SHOES KIT

KIT COMPLET MACHOIRES GARNIES + KIT ACCESSOIRES
COMPLETE BRAKE SHOES KIT + FITTING KIT



FREIN /BRAKE	REF / PN	QTY ESSIEU /AXLE	DESIGNATION BPW ECO 95 (CAME S)
420X180	1903271	1	KIT MACHOIRES GARNIES BPW SN4218 +ACC CO/ LINED BRAKE SHOES KIT
420X200	1909471	1	KIT MACHOIRES GARNIES BPW SN4220 +ACC CO/ LINED BRAKE SHOES KIT

KIT COMPLET MACHOIRES GARNIES + KIT ACCESSOIRES
COMPLETE BRAKE SHOES KIT + FITTING KIT



FREIN /BRAKE	REF / PN	QTY ESSIEU /AXLE	DESIGNATION GIGANT (CAME S)
300X200	1957471	1	KIT MACHOIRES GARNIES SN3020 + ACC CO/ LINED BRAKE SHOES KIT

KIT COMPLET MACHOIRES GARNIES + KIT ACCESSOIRES
COMPLETE BRAKE SHOES KIT + FITTING KIT

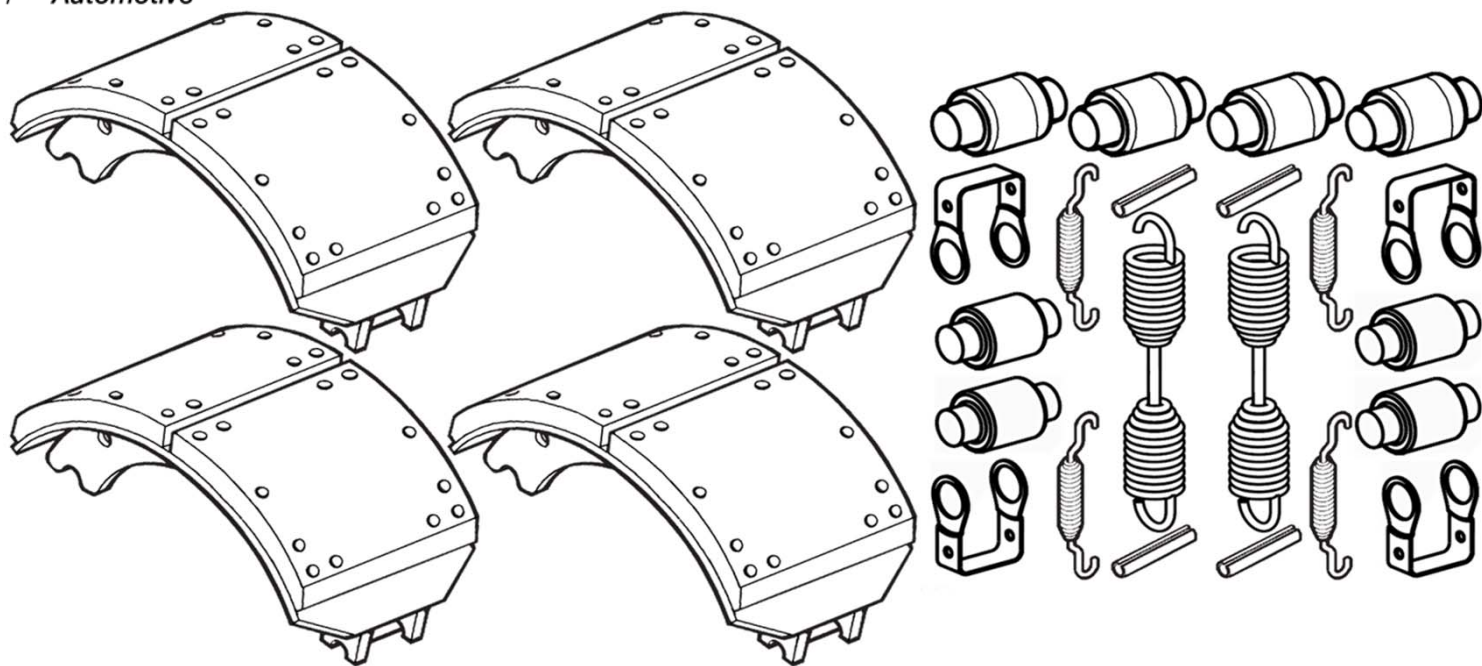

FREIN /BRAKE	TYP	REF / PN	QTY ESSIEU /AXLE	DESIGNATION ROR (CAME S)
419X178	Q	1903770	1	KIT MACHOIRES GARNIES ROR TM , TE +ACC CO/ LINED BRAKE SHOES KIT
419X178	Q	1903771	1	KIT MACHOIRES GARNIES ROR TM , TE +ACC +1MM/ LINED BRAKE SHOES KIT
419X219	Z	1936970	1	KIT MACHOIRES GARNIES ROR TM +ACC CO/ LINED BRAKE SHOES KIT
419X219	Z	1936971	1	KIT MACHOIRES GARNIES ROR TM +ACC +1MM/ LINED BRAKE SHOES KIT

KIT COMPLET MACHOIRES GARNIES + KIT ACCESSOIRES
COMPLETE BRAKE SHOES KIT + FITTING KIT



FREIN /BRAKE	TYP	REF / PN	QTY	ESSIEU /AXLE	DESIGNATION ROR (CAME S)
311X190	AC	1960470	1		KIT MACHOIRES GARNIES ROR TM + ACC CO/ LINED BRAKE SHOES KIT

KIT COMPLET MACHOIRES GARNIES + KIT ACCESSOIRES
COMPLETE BRAKE SHOES KIT + FITTING KIT



FREIN /BRAKE	TYP	REF / PN	QTY ESSIEU /AXLE	DESIGNATION ROR (CAME S)
350X200	B	1990870	1	KIT MACHOIRES GARNIES ROR TM + ACC CO/ LINED BRAKE SHOES KIT

KIT COMPLET MACHOIRES GARNIES + KIT ACCESSOIRES
COMPLETE BRAKE SHOES KIT + FITTING KIT



FREIN /BRAKE	REF / PN	QTY ESSIEU /AXLE	DESIGNATION SAE DUPILLIER (CAME S)
305X200	1976270	1	KIT MACHOIRES GARNIES SAE 3020 + ACC CO/ LINED BRAKE SHOES KIT

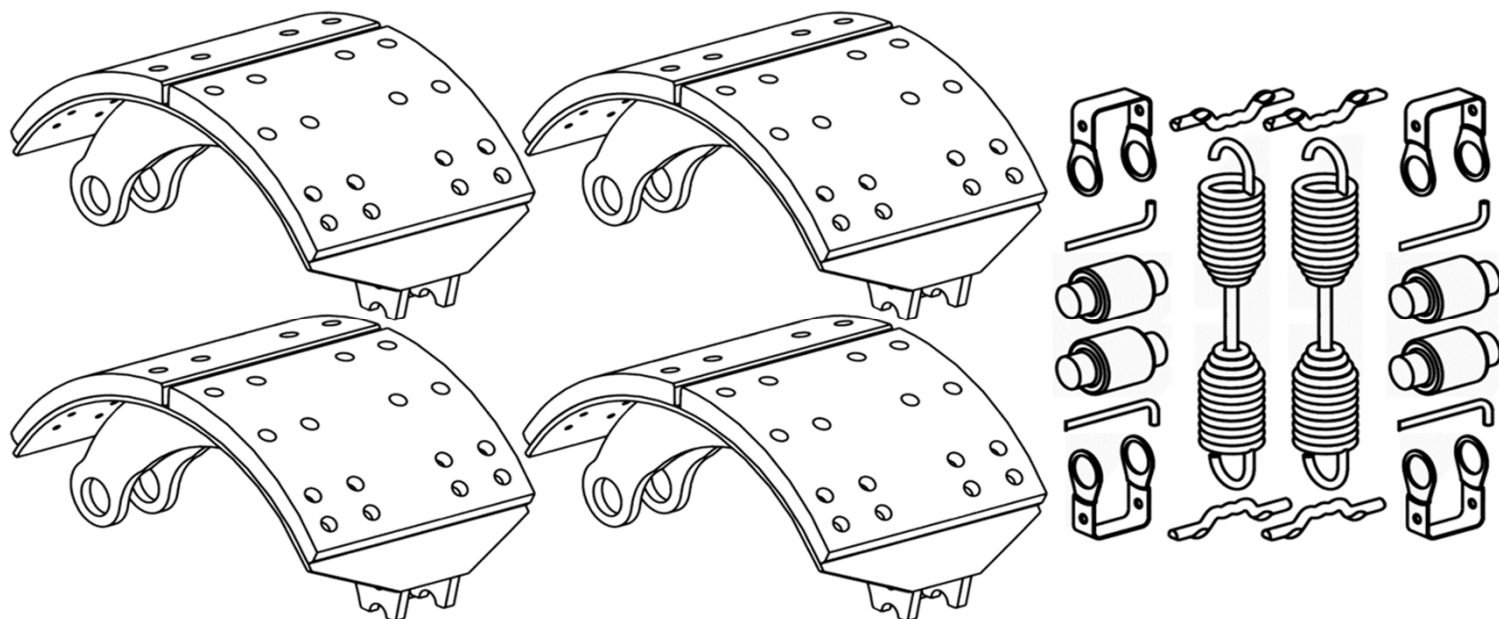



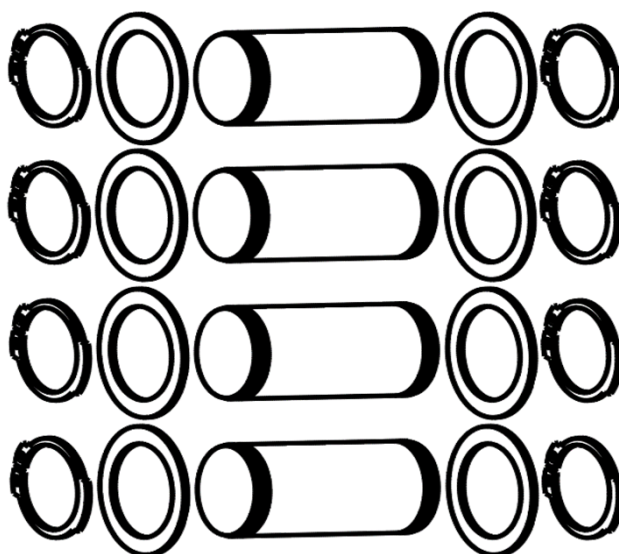

FREIN /BRAKE	REF / PN	QTY ESSIEU /AXLE	DESIGNATION SMB (CAME S)
419X178	1961370	1	KIT MACHOIRES GARNIES SMB C2 +ACC CO/ LINED BRAKE SHOES KIT
419X178	1961370+	1	KIT MACHOIRES GARNIES SMB C2 +ACC CO/ LINED BRAKE SHOES KIT +APF003
419X178	1961371	1	KIT MACHOIRES GARNIES SMB C2 +ACC +1MM/ LINED BRAKE SHOES KIT
419X178	1961371+	1	KIT MACHOIRES GARNIES SMB C2 +ACC +1MM/LINED BRAKE SHOES KIT+APF003
419X203	1955770	1	KIT MACHOIRES GARNIES SMB C1 +ACC CO/ LINED BRAKE SHOES KIT
419X203	1955770+	1	KIT MACHOIRES GARNIES SMB C1 +ACC CO/ LINED BRAKE SHOES KIT+APF003
419X203	1955771	1	KIT MACHOIRES GARNIES SMB C1 +ACC +1MM/ LINED BRAKE SHOES KIT
419X203	1955771+	1	KIT MACHOIRES GARNIES SMB C1 +ACC +1MM/LINED BRAKE SHOES KIT+APF003



FREIN /BRAKE	REF / PN	QTY ESSIEU /AXLE	DESIGNATION SMB (CAME S)
419X178	APF003	1	KIT REP. AXE POINT FIXE SMB/ BRAKE SHOES PIN SET
419X203	APF003	1	KIT REP. AXE POINT FIXE SMB/ BRAKE SHOES PIN SET







ILLUSTRATIONS DRAWINGS

Reference	Designation	WVA	Illustration
AB350929	MACHOIRE NUE RT 310X125 / UNLINED BRAKE SHOES	17352	
AB350891	MACHOIRE NUE RT 325X150 / UNLINED BRAKE SHOES	19709	
AB337220	MACHOIRE NUE RT 360X170 / UNLINED BRAKE SHOES	19255; 19259 TM	
AB337276	ECARTEUR FREIN COIN RT 360X170- 310X125-325X150 / WEDGE BRAKE	17352; 19255; 19259; 19709;	
KRES005	KIT RESSORT DE MACHOIRES RT / SPRING KIT	17352; 19709	
KRES006	KIT RESSORT DE MACHOIRES RT / SPRING KIT	19255; 19259	
AC0001	KIT D'AXE TRANSVERSAL / CROSS SHAFT KIT	17992; 19068, 19071, 19090; 19941	

ILLUSTRATIONS DRAWINGS

Reference	Designation	WVA	Illustration
AC0002	KIT DE TIGE MANUELLE / MANUAL OVERRIDE STEM KIT	17992; 19068, 19071, 19090; 19941	
MAC7992/2	KIT 2 MACHOIRES NUES 410X125 / UNLINED BRAKE SHOES KIT (2 PIECES) Th.:8 mm	17992	
MAC9941/2	KIT 2 MACHOIRES NUES 410X150 / UNLINED BRAKE SHOES KIT (2 PIECES) Th.:8 mm	19941	
MAC9090/2	KIT 2 MACHOIRES NUES 410X175 / UNLINED BRAKE SHOES KIT (2 PIECES) Th.:8 mm	19090	
MAC9071/2	KIT 2 MACHOIRES NUES 410X200 / UNLINED BRAKE SHOES KIT (2 PIECES) Th.:8 mm	19071	
MAC9068/2	KIT 2 MACHOIRES NUES 410X225 / UNLINED BRAKE SHOES KIT (2 PIECES) Th.:8 mm	19068	
AC0003	KIT DE VERROUILLAGE DE REGLEUR / ADJUSTER LOCK KIT	17992; 19068, 19071, 19090; 19941	

ILLUSTRATIONS DRAWINGS

Reference	Designation	WVA	Illustration
AC0004	KIT DE VERROUILLAGE DE REGLEUR / ADJUSTER LOCK KIT	17992; 19068, 19071, 19090; 19941	
AC0005	KIT DE REGLAGE DROIT / ADJUSTER KIT RIGHT	17992; 19068, 19071, 19090; 19941	
AC0006	KIT DE REGLAGE GAUCHE / ADJUSTER KIT LEFT	17992; 19068, 19071, 19090; 19941	
AC0007	JAMBE / STRUT	17992; 19068, 19071, 19090; 19941	
AC0008	VIS NOYEE M6X100-16 / SET SCREW	17992; 19068, 19071, 19090; 19941	
AC0009	PLAQUE COUVERCLE / COVERPLATE	17992; 19068, 19071, 19090; 19941	
AC0010	PIGNON GAUCHE / PINION LEFT	17992; 19068, 19071, 19090; 19941	

ILLUSTRATIONS DRAWINGS

Reference	Designation	WVA	Illustration
AC0011	PIGNON DROIT / PINION RIGHT	17992; 19068, 19071, 19090; 19941	
AC0013	RESSORT EN C / C SPRING	17992; 19068, 19071, 19090; 19941	
AC0014	CACHE - POUSSIÈRE / DIRT EXCLUDER	17992; 19068, 19071, 19090; 19941	
AC0015	AGRAFE À RESSORT / SPRING HOLDDOWN CLIP	17992; 19068, 19071, 19090; 19941	
AC0016	PION DE BUTEE / ABUTMENT PIN	17992; 19068, 19071, 19090; 19941	
MAC9187	MACHOIRE NUE RT 414X220 AVEC GALET / UNLINED BRAKE SHOES WITH ROLLER	19187	
MAC9187K	MACHOIRE NUE RT 414X220 KERAX AVEC GALET / UNLINED BRAKE SHOES WITH ROLLER	19187	



ILLUSTRATIONS DRAWINGS

Reference	Designation	WVA	Illustration
MAC9934	MACHOIRE NUE RT 414X150 AVEC GALET / UNLINED BRAKE SHOES WITH ROLLER	19934	
MAC9934K	MACHOIRE NUE RT 414X150 REDUIT AVEC GALET / UNLINED BRAKE SHOES WITH ROLLER	19934 TM	
MAC9935	MACHOIRE NUE RT 414X175 AVEC GALET / UNLINED BRAKE SHOES WITH ROLLER	19935	
MAC9935K	MACHOIRE NUE RT 414X175 KERAX AVEC GALET / UNLINED BRAKE SHOES WITH ROLLER	19935	
AC0018	GALET / ROLLER	19187; 19934; 19935	
AC0019	AXE DE GALET / ROLLER AXE	19187; 19934; 19935	
AC0021	ROTULE 42X62X25 / BALL	19187; 19934; 19935	





ILLUSTRATIONS DRAWINGS

Reference	Designation	WVA	Illustration
APF001	AXE POINT FIXE / ANCHOR FIXED	19187; 19934; 19935	
APF001/1	GOUPILLE MECANIMBUS / PIN	19187; 19934; 19935	
APF001/2	JOINT TORIQUE / O-RING	19187; 19934; 19935	
APF001/3	BAGUE POINT FIXE / BUSH	19187; 19934; 19935	
AXE001	AXE RESSORT RT / AXIS SPRING	19187; 19934; 19935	
AXE002	AXE RESSORT RT / AXIS SPRING	19187; 19934; 19935	
BE0001	BAGUE D'ETANCHEITE 120X160X15 / O- SEAL	19187; 19934; 19935	
RES001	RESSORT DE MACHOIRES RT / RETURN SPRING 154X38X5	19187; 19934; 19935	
RES002	RESSORT DE MACHOIRES RT / RETURN SPRING 236X28X4	19187; 19934; 19935	
RES004	RESSORT DE MACHOIRES RT / RETURN SPRING 251X34X5	19187; 19934; 19935	

ILLUSTRATIONS DRAWINGS

Reference	Designation	WVA	Illustration
MAC9063/64	MACHOIRE NUE DAF 420X200 / UNLINED BRAKE SHOES	19063; 19064	
RES005	RESSORT DE MACHOIRES DAF / RETURN SPRING 158X40X5,3	19010; 19052; 19063; 19069; 19900	
MAC9503	MACHOIRE NUE IVECO 360X170 / UNLINED BRAKE SHOES	19503	
ECF001	ECARTEUR DAF IVECO PERROT 360X170 SIMPLEX / WEDGE BRAKE	19503	
ECF002	ECARTEUR IVECO PERROT 410X180 410X200 SIMPLEX / WEDGE BRAKE	19091; 19098	
KRES007	KIT RESSORT DE MACHOIRES IVECO PERROT / SPRING KIT	19503	





ILLUSTRATIONS DRAWINGS

Reference	Designation	WVA	Illustration
KTU010	TEMOINS USURE IVECO PERROT / WEAR INDICATOR (L.: 560mm - 2 pieces)	19503	
KTU013	TEMOINS USURE IVECO MERITOR / WEAR INDICATOR (L.: 950mm - 2 pieces)	19503	
KTU012	TEMOINS USURE IVECO MERITOR / WEAR INDICATOR (L.: 955mm - 2 pieces)	19503	
MAC9099	MACHOIRE NUE PERROT 410X182 / UNLINED BRAKE SHOES	19099; 19100	
MAC9091/98	MACHOIRE NUE PERROT 410X202 / UNLINED BRAKE SHOES	19091; 19098	
KRES008	KIT RESSORT DE MACHOIRES IVECO PERROT / SPRING KIT	19091; 19098; 19099; 19100	

ILLUSTRATIONS DRAWINGS

Reference	Designation	WVA	Illustration
98032100	TEMOIN USURE IVECO PERROT / WEAR INDICATOR (L.: 1315mm 1 piece)	19091; 19098; 19099; 19100	
MAC9495CAST	MACHOIRE NUE MAN MERCEDES 410X183 + GALET / UNLINED BRAKE SHOES WITH ROLLER	19495	
MAC9496CAST	MACHOIRE NUE MAN MERCEDES 410X223 +GALET / UNLINED BRAKE SHOES WITH ROLLER	19496	
KRG001	KIT REP. GALET MERCEDES/ ROLLER FITTING KIT	19494; 19495; 19496; MAC9495 CAST; MAC9496 CAST	
APF002	KIT REP. AXE POINT FIXE MAN MERCEDES/ BRAKE SHOES PIN SET	17238; 17276; 17682; 19494; 19495; 19496;	
RES007	RESSORT DE MACHOIRES MAN MERCEDES / RETURN SPRING 228x30x4	19495	
RES008	RESSORT DE MACHOIRES MAN MERCEDES / RETURN SPRING 235X26X4	19495; 19496	

ILLUSTRATIONS DRAWINGS

Reference	Designation	WVA	Illustration
RES009	RESSORT DE MACHOIRES MAN MERCEDES / RETURN SPRING 245X26X4	19495; 19496	
RES013	RESSORT DE MACHOIRES MERCEDES / RETURN SPRING 232X28X4	19495; 19496	
98017002	TEMOINS USURE MERCEDES (EX 98017000) / WEAR INDICATOR (L.: 120mm - 2 pieces)	15162; 17238; 17278; 17280; 17287; 17290; 19112; 19494; 19495; 19496; 19505; 19506; 19706; 19707; 19936; 19937;	
98017102	TEMOINS USURE MERCEDES +2 MM (EX 98017100)/ WEAR INDICATOR (L.: 120mm - 2 pieces)	15162; 17238; 17278; 17280; 17287; 17290; 19112; 19494; 19495; 19496; 19505; 19506; 19706; 19707; 19936; 19937;	
98023500	TEMOINS USURE MAN CO & +1MM/ WEAR INDICATOR (L.: 194mm - 2 pieces)	17238; 19495; 19496; 19713	

ILLUSTRATIONS DRAWINGS

Reference	Designation	WVA	Illustration
98023600	TEMOINS USURE MAN +2MM & +3MM (FAT)/ WEAR INDICATOR (L.: 194mm - 2 pieces)	17238; 19495; 19496; 19713	
MAC9932	MACHOIRE NUE SCANIA+GALET 413X203 / UNLINED BRAKE SHOES +ROLLER	TM 19932	
MAC9933	MACHOIRE NUE SCANIA+GALET 413X254 / UNLINED BRAKE SHOES +ROLLER	19933	
RES006	RESSORT DE MACHOIRES SCANIA / RETURN SPRING 262X24X4	19931; 19932; 19933	
AC0039	PION DE MAINTIEN SCANIA / ABUTMENT PIN	19931; 19932; 19933	
MAC9974	MACHOIRE NUE IRISBUS 414X200 / UNLINED BRAKE SHOES	19974	
98016800	TEMOINS USURE MERCEDES/ WEAR INDICATOR (L. : 150mm / 4 pieces)	11019; 11025; 11582; 11583; 13020; 13532; 13533; 15030; 15742; 15743;	
98016900	TEMOINS USURE MERCEDES/ WEAR INDICATOR (L. : 200mm / 4 pieces)	15059; 15869; 15870; 17350; 17351; 17973; 17974; 17975; 17976;	

ILLUSTRATIONS DRAWINGS

Reference	Designation	WVA	Illustration
KRES009	KIT RESSORT DE MACHOIRES	19109; 19110; 19116; 19119;	
ACK003	KIT CLIP DE FIXATION MACHOIRES IVECO STOPMASTER / HOLD DOWN KIT	19109; 19110; 19116; 19119; 19553; 19554; 19555; 19556; 19714; 19715; 19716; 19717;	
KTU011	TEMOIN USURE IVECO ROCKWELL/ WEAR INDICATOR (L.: 950mm 2 pieces)	19109; 19110; 19116; 19119;	
AC0023	TÊTE DE REGLAGE / ADJUSTING BOLT	19109; 19110; 19116; 19119;	
AC0024	MANCHON DE BOULON DE RÉGLAGE / ADJUSTING BOLT SLEEVE	19109; 19110; 19116; 19119;	
AC0025	PLONGEUR D'ECARTEMENT GAUCHE / ANCHOR PLUNGER LEFT	19109; 19110; 19116; 19119;	





**ILLUSTRATIONS
DRAWINGS**

Reference	Designation	WVA	Illustration
AC0026	PLONGEUR D'ECARTEMENT DROIT / ANCHOR PLUNGER RIGHT	19109; 19110; 19116; 19119;	
AC0027	AJUSTEMENT DU PLONGEUR D'ECARTEMENT / ADJUSTING PLUNGER	19109; 19110; 19116; 19119; 19553; 19554; 19555; 19556; 19714; 19715; 19716; 19717;	
AC0028	JOINT DU PLONGEUR D'ECARTEMENT / SEAL - ANCHOR PLUNGER	19109; 19110; 19116; 19119;	
AC0029	JOINT DE TÊTE DE RÉGLAGE / SEAL - ADJUSTER PLUNGER	19109; 19110; 19116; 19119; 19553; 19554; 19555; 19556; 19714; 19715; 19716; 19717;	
AC0030	VIS GUIDE / GUIDE SCREW	19109; 19110; 19116; 19119;	
AC0031	ENSEMBLE CLIQUET DE GUIDAGE / GUIDE PAWL ASSEMBLY	19109; 19110; 19116; 19119;	



ILLUSTRATIONS DRAWINGS

Reference	Designation	WVA	Illustration
AC0032	COIN ASSEMBLE / WEDGE ASSEMBLY	19109; 19110; 19116; 19119; 19553; 19554; 19555; 19556; 19714; 19715; 19716; 19717;	
98032200	TEMOIN USURE IVECO ROCKWELL/ WEAR INDICATOR (L.: 1315mm 1 piece)	19553; 19554; 19555; 19556; 19714; 19715; 19716; 19717;	
KRES010	KIT RESSORT DE MACHOIRES IVECO STOPMASTER SIMPLEX / SPRING KIT	19553; 19554; 19555; 19556; 19714; 19715; 19716; 19717;	
AC0034	MANCHON DE BOULON DE RÉGLAGE / ADJUSTING BOLT SLEEVE	19553; 19554; 19555; 19556; 19714; 19715; 19716; 19717;	
AC0035	ENSEMBLE CLIQUET DE GUIDAGE / GUIDE PAWL ASSEMBLY	19553; 19554; 19555; 19556; 19714; 19715; 19716; 19717;	
AC0036	KIT PLONGEUR D'ANCRAGE GAUCHE/ ANCHOR PLUNGER KIT LEFT	19553; 19554; 19555; 19556; 19714; 19715; 19716; 19717;	

ILLUSTRATIONS DRAWINGS

Reference	Designation	WVA	Illustration
AC0037	KIT PLONGEUR D'ANCRAGE DROIT/ ANCHOR PLUNGER KIT RIGHT	19553; 19554; 19555; 19556; 19714; 19715; 19716; 19717;	
AC0038	COIN ASSEMBLE / WEDGE ASSEMBLY	19553; 19554; 19555; 19556; 19714; 19715; 19716; 19717;	
ECF003	ECARTEUR GRUE PERROT SIMPLEX 410X180 500X120 500X160 / WEDGE BRAKE FOR MOBILE CRANE	19723; 19113; 17237; 17374; 19687; 19042;	
ECF004	ECARTEUR GRUE PERROT DUPLEX 410X180 500X180/ WEDGE BRAKE FOR MOBILE CRANE	19723; 19113; 19690; 19041;	

**ILLUSTRATIONS
DRAWINGS**

Reference	Designation	WVA	Illustration
ECF005	ECARTEUR GRUE KNOTT SIMPLEX 410X180 500X120 500X160 / WEDGE BRAKE FOR MOBILE CRANE	19723; 19113; 17237; 17374; 19687; 19042;	
ECF006	ECARTEUR GRUE KNOTT DUPLEX 410X180 500X180/ WEDGE BRAKE FOR MOBILE CRANE	19723; 19113; 19690; 19041;	
KRES011	KIT RESSORT DE MACHOIRES IVECO PERROT 270X80 POUR 1 FREIN / SPRING KIT FOR 1 BRAKE	15030	



ECF005

ECF006

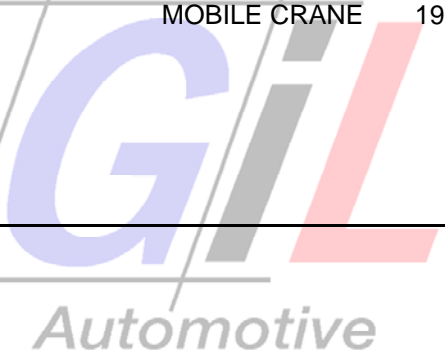
KRES011

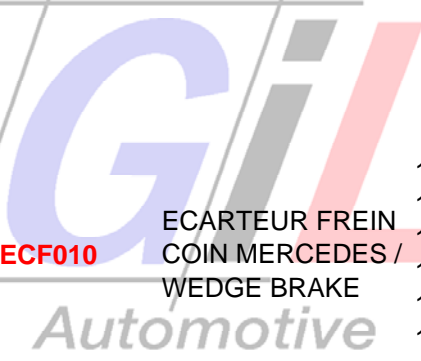

ILLUSTRATIONS DRAWINGS

Reference	Designation	WVA	Illustration
ECF007	ECARTEUR AUTOMATIQUE IVECO MERCEDES PERROT 270X80 / AUTOMATIC ADJUSTER	15030	
<div style="display: flex; align-items: center;">  <div style="text-align: right;"> <p>TM</p> <p>17278; 17280; 17287; 17290; 19505; 19506</p> </div> </div>	ECF010 ECARTEUR FREIN COIN MERCEDES / WEDGE BRAKE		

CORRESPONDANCE DES REFERENCES CROSS REFERENCE LIST

MARQUE	REF OES	REFERENCE
ABEX	AK2037159	1960470
ABEX	AK2041927	1960870
ABEX	AK2043170	1976270
ABEX	AK2308159	1990870
ABEX	AK2620929	1961370
ABEX	AK2622929	1955770
ABEX	AK2751173	1903070
ABEX	AK2858927	1903770
ABEX	AK2870929	1903270
ABEX	AK2871929	1928370
ABEX	AK2878929	1909470
ABEX	AK2879929	1947770
ABEX	AK2895159	1936970
ABEX	AK4620929	1961371
ABEX	AK4622929	1955771
ABEX	AK4858927	1903771
ABEX	AK4895159	1936971
ABEX	AK8870929	1903271
ABEX	AK8878929	1909471
ABEX	B2002	1957306
ABEX	B2008	1978610
ABEX	B2009	1982410
ABEX	B2029	1978611
ABEX	B2030	1516203
ABEX	B2031	1727806
ABEX	B2032	1728006
ABEX	B2033	1728705
ABEX	B2037	1960408
ABEX	B2041	1986201
ABEX	B2043	1976210
ABEX	B2044	1976002
ABEX	B2045	1987701
ABEX	B2046	19880xx
ABEX	B2049	17897xx
ABEX	B2050	19125xx
ABEX	B2053	1990210
ABEX	B2061	1925501
ABEX	B2063	19923xx
ABEX	B2064	1729006
ABEX	B2066	1950607
ABEX	B2083	1956202
ABEX	B2084	1916602
ABEX	B2091	19684xx
ABEX	B2092	19685xx
ABEX	B2093	1970601
ABEX	B2094	1970701
ABEX	B2095	1979901
ABEX	B2096	1988501
ABEX	B2097	1949602

MARQUE	REF OES	REFERENCE
ABEX	B2105	1957427
ABEX	B2112	1779501
ABEX	B2143	19946xx
ABEX	B2148	1946703
ABEX	B2150	1799201
ABEX	B2152	1994102
ABEX	B2160	1723802
ABEX	B2161	1768202
ABEX	B2162	17739xx
ABEX	B2169	1969905
ABEX	B2170	1984906
ABEX	B2177	1766402
ABEX	B2179	1993402
ABEX	B2180	1993502
ABEX	B2181	19974xx
ABEX	B2182	1918702
ABEX	B2184	19634xx
ABEX	B2185	1974302
ABEX	B2202	1949402
ABEX	B2203	1949502
ABEX	B2208	1939302
ABEX	B2212	1956002
ABEX	B2302	1951512
ABEX	B2305	19543xx
ABEX	B2308	1990803
ABEX	B2309	17357xx
ABEX	B2311	1975803
ABEX	B2322	1587906
ABEX	B2323	1798806
ABEX	B2325	1971802
ABEX	B2338	1726301
ABEX	B2345	1926901
ABEX	B2354	1915002
ABEX	B2358	1991201
ABEX	B2366	1989208
ABEX	B2369	1925602
ABEX	B2409	1936605
ABEX	B2420	17704xx
ABEX	B2481	1993201
ABEX	B2483	19618xx
ABEX	B2484	1961705
ABEX	B2487	1993301
ABEX	B2489	19896xx
ABEX	B2497	19680xx
ABEX	B2498	19682xx
ABEX	B2500	1716101
ABEX	B2501	1907502
ABEX	B2502	19359xx
ABEX	B2503	1920005

Les correspondances de références ont pour seul objectif d'aider la recherche de référence

Cross references are there for the sole purpose of helping the reference search

CORRESPONDANCE DES REFERENCES CROSS REFERENCE LIST

MARQUE	REF OES	REFERENCE
ABEX	B2506	19672xx
ABEX	B2509	1799101
ABEX	B2510	1993101
ABEX	B2541	19168xx
ABEX	B2620	1961313
ABEX	B2622	1955713
ABEX	B2675	1954201
ABEX	B2676	19492xx
ABEX	B2677	1934302
ABEX	B2678	1934202
ABEX	B2679	1950505
ABEX	B2703	19905xx
ABEX	B2704	19887xx
ABEX	B2706	19820xx
ABEX	B2707	19306xx
ABEX	B2708	1928308
ABEX	B2709	1947706
ABEX	B2710	1992101
ABEX	B2711	1901005
ABEX	B2712	1905201
ABEX	B2713	1906303
ABEX	B2717	19745xx
ABEX	B2720	1701703
ABEX	B2721	1917705
ABEX	B2722	19825xx
ABEX	B2723	1951701
ABEX	B2724	19396xx
ABEX	B2725	19397xx
ABEX	B2726	1995201
ABEX	B2727	1956801
ABEX	B2728	17742xx
ABEX	B2729	19558xx
ABEX	B2730	19723xx
ABEX	B2731	1745605
ABEX	B2732	1964703
ABEX	B2733	17012xx
ABEX	B2734	1902401
ABEX	B2735	1971201
ABEX	B2736	19251xx
ABEX	B2737	1955301
ABEX	B2738	1955502
ABEX	B2739	1938414
ABEX	B2740	19114xx
ABEX	B2741	1971401
ABEX	B2742	1971613
ABEX	B2743	1947905
ABEX	B2744	1949005
ABEX	B2745	1991403
ABEX	B2746	1906901

MARQUE	REF OES	REFERENCE
ABEX	B2747	1992802
ABEX	B2748	19826xx
ABEX	B2749	1970803
ABEX	B2750	18014xx
ABEX	B2751	1903001
ABEX	B2752	1941001
ABEX	B2753	1997201
ABEX	B2754	1909002
ABEX	B2755	1907102
ABEX	B2756	1906802
ABEX	B2757	1909902
ABEX	B2758	1909102
ABEX	B2800	1996708
ABEX	B2822	1985502
ABEX	B2858	1903712
ABEX	B2869	19406xx
ABEX	B2870	1903230
ABEX	B2873	1903616
ABEX	B2878	1909437
ABEX	B2880	19338xx
ABEX	B2891	1936515
ABEX	B2894	1990002
ABEX	B2895	1936912
ABEX	B2896	1988802
ABEX	B2897	1989002
ABEX	B2898	1910902
ABEX	B2899	1911602
ABEX	B2900	1919101
ABEX	B2901	1919201
ABEX	B4002	1957307
ABEX	B4009	19824xx
ABEX	B4029	1978612
ABEX	B4030	15162xx
ABEX	B4031	1727807
ABEX	B4032	1728007
ABEX	B4033	1728706
ABEX	B4037	1960409
ABEX	B4041	1986202
ABEX	B4043	1976211
ABEX	B4049	17897xx
ABEX	B4053	1990212
ABEX	B4061	1925502
ABEX	B4063	19923xx
ABEX	B4064	1729007
ABEX	B4066	1950608
ABEX	B4083	1956204
ABEX	B4093	1970618
ABEX	B4094	1970702
ABEX	B4095	1979902

Les correspondances de références ont pour seul objectif d'aider la recherche de référence

Cross references are there for the sole purpose of helping the reference search

CORRESPONDANCE DES REFERENCES CROSS REFERENCE LIST

MARQUE	REF OES	REFERENCE
ABEX	B4096	19885xx
ABEX	B4097	1949604
ABEX	B4105	1957428
ABEX	B4112	17795xx
ABEX	B4143	19946xx
ABEX	B4148	19467xx
ABEX	B4150	17992xx
ABEX	B4152	19941xx
ABEX	B4160	1723804
ABEX	B4161	17682xx
ABEX	B4169	1969906
ABEX	B4177	17664xx
ABEX	B4179	1993410
ABEX	B4180	1993514
ABEX	B4181	19974xx
ABEX	B4182	1918704
ABEX	B4184	19634xx
ABEX	B4185	19743xx
ABEX	B4202	1949404
ABEX	B4203	1949504
ABEX	B4208	1939304
ABEX	B4212	19560xx
ABEX	B4302	1951513
ABEX	B4305	19543xx
ABEX	B4308	1990804
ABEX	B4309	17357xx
ABEX	B4311	1975804
ABEX	B4322	1587907
ABEX	B4323	1798807
ABEX	B4325	19718xx
ABEX	B4345	19269xx
ABEX	B4354	19150xx
ABEX	B4358	1991202
ABEX	B4366	1989202
ABEX	B4369	19256xx
ABEX	B4409	1936607
ABEX	B4420	17704xx
ABEX	B4481	1993202
ABEX	B4487	1993307
ABEX	B4489	19896xx
ABEX	B4500	1716101
ABEX	B4501	19075xx
ABEX	B4503	19200xx
ABEX	B4506	19672xx
ABEX	B4509	17991xx
ABEX	B4510	1993102
ABEX	B4620	1961314
ABEX	B4622	1955714
ABEX	B4675	19542xx

MARQUE	REF OES	REFERENCE
ABEX	B4676	19492xx
ABEX	B4677	1934304
ABEX	B4678	19342xx
ABEX	B4679	1950506
ABEX	B4707	19306xx
ABEX	B4708	1928309
ABEX	B4709	1947707
ABEX	B4711	1901006
ABEX	B4712	19052xx
ABEX	B4713	1906304
ABEX	B4720	1701704
ABEX	B4721	19177xx
ABEX	B4726	1995202
ABEX	B4727	1956802
ABEX	B4728	17742xx
ABEX	B4729	19558xx
ABEX	B4731	1745606
ABEX	B4732	19647xx
ABEX	B4734	19024xx
ABEX	B4735	1971202
ABEX	B4737	19553xx
ABEX	B4739	1938415
ABEX	B4740	19114xx
ABEX	B4742	1971602
ABEX	B4744	19490xx
ABEX	B4751	1903002
ABEX	B4754	1909005
ABEX	B4755	1907105
ABEX	B4756	1906805
ABEX	B4757	19099xx
ABEX	B4758	19091xx
ABEX	B4800	1996709
ABEX	B4858	1903713
ABEX	B4870	1903231
ABEX	B4873	1903617
ABEX	B4878	1909439
ABEX	B4880	19338xx
ABEX	B4891	1936513
ABEX	B4894	1990004
ABEX	B4895	1936913
ABEX	B4896	1988804
ABEX	B4897	1989004
ABEX	B4898	1910903
ABEX	B4899	19116xx
ABEX	B4900	1919102
ABEX	B4901	1919202
ABEX	B6097	1949605
ABEX	B6105	1957429
ABEX	B6179	19934xx

Les correspondances de références ont pour seul objectif d'aider la recherche de référence

Cross references are there for the sole purpose of helping the reference search

CORRESPONDANCE DES REFERENCES CROSS REFERENCE LIST

MARQUE	REF OES	REFERENCE
ABEX	B6180	19935xx
ABEX	B6182	19187xx
ABEX	B6202	1949405
ABEX	B6203	1949505
ABEX	B6208	19393xx
ABEX	B6481	19932xx
ABEX	B6501	19075xx
ABEX	B6503	19200xx
ABEX	B6510	19931xx
ABEX	B6620	19613xx
ABEX	B6708	1928310
ABEX	B6738	19555xx
ABEX	B6739	1938416
ABEX	B6741	1971403
ABEX	B6754	19071xx
ABEX	B6756	19068xx
ABEX	B6858	1903714
ABEX	B6870	19032xx
ABEX	B6878	1909440
ABEX	B6895	1936914
ABEX	FAI200	98016800
ABEX	FAI201	98016900
ABEX	FAI202	98017002
ABEX	FAI203	98017102
ABEX	FAI205	98023500
ABEX	FAI206	98023600
ABEX	FAI207	98032200
ABEX	FAI208	98032100
ABEX	J0300	17134xx
ABEX	J0301	17546xx
ABEX	J0302	19351xx
ABEX	J0303	17316xx
ABEX	J0305	1911101
ABEX	J0306	17557xx
ABEX	J0307	15789xx
ABEX	J0308	17555xx
ABEX	J0309	17560xx
ABEX	J0310	17662xx
ABEX	J0311	15562xx
ABEX	J0312	17556xx
ABEX	J0313	15837xx
ABEX	J0314	17934xx
ABEX	J0315	17932xx
ABEX	J0316	17477xx
ABEX	J0317	17713xx
ABEX	J0318	17229xx
ABEX	J0319	15794xx
ABEX	J0320	17854xx
ABEX	J1001	1101901

MARQUE	REF OES	REFERENCE
ABEX	J1002	1302001
ABEX	J1031	19182xx
ABEX	J1033	15057xx
ABEX	J1035	17105xx
ABEX	J1045	1709401
ABEX	J1046	17792xx
ABEX	J1048	19996xx
ABEX	J1049	19444xx
ABEX	J1050	17612xx
ABEX	J1051	1708802
ABEX	J1222	17497xx
ABEX	J1224	17307xx
ABEX	J1225	17805xx
ABEX	J1226	1962004
ABEX	J1227	1782704
ABEX	J1228	17829xx
ABEX	J1229	1783102
ABEX	J1232	1910301
ABEX	J1233	17761xx
ABEX	J1240	1740910
ABEX	J1241	17500xx
ABEX	J1243	17247xx
ABEX	J1248	1583101
ABEX	J1253	1573204
ABEX	J1287	17804xx
ABEX	J1288	19622xx
ABEX	J1293	1503002
ABEX	J1295	1904902
ABEX	J1296	1904902
ABEX	J1304	17298xx
ABEX	J1305	1727601
ABEX	J1306	1916001
ABEX	J1307	17869xx
ABEX	J1308	19694xx
ABEX	J1312	17309xx
ABEX	J1325	1946301
ABEX	J1326	19655xx
ABEX	J1338	19919xx
ABEX	J1339	1946301
ABEX	J1345	1558008
ABEX	J1346	1740909
ABEX	J1348	17323xx
ABEX	J1350	17352xx
ABEX	J1351	19709xx
ABEX	J1356	19918xx
ABEX	J1357	15207xx
ABEX	J1358	15494xx
ABEX	J1359	1748206
ABEX	J1360	1581702

Les correspondances de références ont pour seul objectif d'aider la recherche de référence

Cross references are there for the sole purpose of helping the reference search

CORRESPONDANCE DES REFERENCES CROSS REFERENCE LIST

MARQUE	REF OES	REFERENCE
ABEX	J1361	1790007
ABEX	J1410	15698xx
ABEX	J1411	17880xx
ABEX	J1412	19821xx
ABEX	J1413	17879xx
ABEX	J1420	13464xx
ABEX	J1421	1792408
ABEX	J1482	13053xx
ABEX	J1510	15104xx
ABEX	J1511	17744xx
ABEX	J1512	1534906
ABEX	J1516	1740805
ABEX	J1517	1748107
ABEX	J1518	19072xx
ABEX	J1519	15282xx
ABEX	J1521	19544xx
ABEX	J1522	17592xx
ABEX	J1523	19401xx
ABEX	J1524	19405xx
ABEX	J1535	17885xx
ABEX	J1675	1950308
ABEX	J1678	19371xx
ABEX	J1679	1505901
ABEX	J1680	1735003
ABEX	J1681	1735103
ABEX	J1682	15280xx
ABEX	J1684	15799xx
ABEX	J1685	1709601
ABEX	J1686	17362xx
ABEX	J1687	19700xx
ABEX	J2002	1302002
ABEX	J2031	19182xx
ABEX	J2045	17094xx
ABEX	J2046	17792xx
ABEX	J2051	1708804
ABEX	J2225	17805xx
ABEX	J2226	1962005
ABEX	J2227	1782705
ABEX	J2228	17829xx
ABEX	J2229	17831xx
ABEX	J2240	17409xx
ABEX	J2253	1573205
ABEX	J2287	17804xx
ABEX	J2288	19622xx
ABEX	J2293	1503003
ABEX	J2295	1904911
ABEX	J2296	1904911
ABEX	J2306	1916002
ABEX	J2307	17869xx

MARQUE	REF OES	REFERENCE
ABEX	J2308	19694xx
ABEX	J2312	17309xx
ABEX	J2325	19463xx
ABEX	J2338	19919xx
ABEX	J2339	19463xx
ABEX	J2345	15580xx
ABEX	J2346	17409xx
ABEX	J2350	17352xx
ABEX	J2351	19709xx
ABEX	J2356	19918xx
ABEX	J2357	15207xx
ABEX	J2358	15494xx
ABEX	J2359	1748207
ABEX	J2361	17900xx
ABEX	J2411	17880xx
ABEX	J2412	19821xx
ABEX	J2413	17879xx
ABEX	J2421	1792409
ABEX	J2512	1534907
ABEX	J2516	1740806
ABEX	J2517	1748108
ABEX	J2518	19072xx
ABEX	J2521	19544xx
ABEX	J2535	17885xx
ABEX	J2675	1950307
ABEX	J2679	15059xx
ABEX	J2680	1735004
ABEX	J2681	1735104
ABEX	J3051	1708806
ABEX	J3253	1573206
ABEX	J3296	19049xx
ABEX	J3307	17869xx
ABEX	J3308	19694xx
ABEX	J3325	19463xx
ABEX	J3357	15207xx
ABEX	J3358	15494xx
ABEX	J3359	1748208
ABEX	J3516	1740807
ABEX	J3517	1748109
BPW	0300093862	1957307
BPW	0300093863	1957425
BPW	0300099476	1903230
BPW	0309203040	11280xx
BPW	0309204010	11478xx
BPW	0309205060	1108401
BPW	0309205070	11084xx
BPW	0309205110	11084xx
BPW	0309205120	1108401
BPW	0309205170	1108401

Les correspondances de références ont pour seul objectif d'aider la recherche de référence

Cross references are there for the sole purpose of helping the reference search

CORRESPONDANCE DES REFERENCES CROSS REFERENCE LIST

MARQUE	REF OES	REFERENCE
BPW	0309208090	11556xx
BPW	0309208100	11556xx
BPW	0309211010	15004xx
BPW	0309211060	1500401
BPW	0309211070	15004xx
BPW	0309211080	1500401
BPW	0309211170	1500401
BPW	0309212010	17183xx
BPW	0309212500	17347xx
BPW	0309212510	1734703
BPW	0309212520	17347xx
BPW	0309213010	19102xx
BPW	0309213020	1910205
BPW	0309213030	1910205
BPW	0309213050	19396xx
BPW	0309213090	1957307
BPW	0309213100	1957306
BPW	0309213190	1957306
BPW	0309213200	1957307
BPW	0309213300	1957307
BPW	0309213310	1957306
BPW	0309213320	1957307
BPW	0309213430	1957307
BPW	0309213440	1957306
BPW	0309213450	1957307
BPW	0309214020	1910301
BPW	0309214030	1910301
BPW	0309214040	19397xx
BPW	0309214080	1957425
BPW	0309214120	1957422
BPW	0309214130	1957425
BPW	0309214270	1957422
BPW	0309214280	1957425
BPW	0309214290	1957424
BPW	0309214310	1957431
BPW	0309214330	1957422
BPW	0309214340	1957425
BPW	0309214350	1957424
BPW	0309214360	1957431
BPW	0309214440	1957422
BPW	0309214450	1957422
BPW	0309214460	1957425
BPW	0309214470	1957424
BPW	0309218010	15044xx
BPW	0309218050	1504401
BPW	0309218060	15044xx
BPW	0309218070	1504401
BPW	0309218120	1504401
BPW	0309219030	1990212

MARQUE	REF OES	REFERENCE
BPW	0309219080	1990210
BPW	0309219090	1990210
BPW	0309219200	1995201
BPW	0309219210	1995201
BPW	0309219220	1995201
BPW	0309219230	1995201
BPW	0309219240	1990210
BPW	0309219240	19903xx
BPW	0309219250	1990210
BPW	0309219300	1990212
BPW	0309219310	1990212
BPW	0309219330	1990213
BPW	0309219460	1995202
BPW	0309219470	1995202
BPW	0309219520	1990210
BPW	0309219520	1990212
BPW	0309219530	1990210
BPW	0309219530	1990212
BPW	0309219540	1990210
BPW	0309219550	1990210
BPW	0309219560	1990212
BPW	0309219570	1990212
BPW	0309219590	1990213
BPW	0309219600	1995202
BPW	0309219610	1995202
BPW	0309219620	1995201
BPW	0309219630	1995201
BPW	0309219640	1995202
BPW	0309219650	1995202
BPW	0309219720	1995202
BPW	0309219730	1995202
BPW	0309219740	1990212
BPW	0309219880	1990210
BPW	0309220010	1524701
BPW	0309220020	15247xx
BPW	0309220060	15147xx
BPW	0309220090	15247xx
BPW	0309220120	1524701
BPW	0309220150	1524701
BPW	0309221010	17122xx
BPW	0309222010	1711501
BPW	0309222030	1711502
BPW	0309222080	1700101
BPW	0309222090	1700102
BPW	0309222170	1700101
BPW	0309222180	1711501
BPW	0309222250	1711501
BPW	0309222350	1700101
BPW	0309223020	1919101

Les correspondances de références ont pour seul objectif d'aider la recherche de référence

Cross references are there for the sole purpose of helping the reference search

CORRESPONDANCE DES REFERENCES CROSS REFERENCE LIST

MARQUE	REF OES	REFERENCE
BPW	0309225010	1920005
BPW	0309225020	19200xx
BPW	0309225040	19200xx
BPW	0309225070	19093xx
BPW	0309225130	19200xx
BPW	0309225160	19200xx
BPW	0309225170	1920005
BPW	0309225350	1920005
BPW	0309225400	1920005
BPW	0309225410	19200xx
BPW	0309225470	1920005
BPW	0309225480	1920005
BPW	0309225490	19200xx
BPW	0309226010	1903230
BPW	0309226030	1903231
BPW	0309226040	1903232
BPW	0309226050	1903232
BPW	0309226060	1903230
BPW	0309226060	1903234
BPW	0309226080	1903231
BPW	0309226100	1903230
BPW	0309226110	1903230
BPW	0309226120	1903232
BPW	0309226210	1903230
BPW	0309226250	1903230
BPW	0309226250	1903234
BPW	0309226260	1903230
BPW	0309226310	1903231
BPW	0309226320	1903230
BPW	0309226450	1903230
BPW	0309226480	1903230
BPW	0309226560	1903230
BPW	0309226570	1903231
BPW	0309226580	1903232
BPW	0309226660	1903230
BPW	0309226710	1903237
BPW	0309226760	1903230
BPW	0309226770	1903231
BPW	0309226780	1903232
BPW	0309226790	1903231
BPW	0309226840	1903231
BPW	0309226850	1903230
BPW	0309226860	1903231
BPW	0309226870	1903232
BPW	0309226890	1903231
BPW	0309226930	1903231
BPW	0309226980	1919101
BPW	0309227010	1909437
BPW	0309227020	1909439

MARQUE	REF OES	REFERENCE
BPW	0309227030	1909440
BPW	0309227040	1909440
BPW	0309227050	1909439
BPW	0309227060	1909437
BPW	0309227070	1909439
BPW	0309227150	1909437
BPW	0309227180	1909437
BPW	0309227180	1909442
BPW	0309227190	1909437
BPW	0309227220	1909439
BPW	0309227230	1909439
BPW	0309227240	1909437
BPW	0309227260	1909437
BPW	0309227430	1909437
BPW	0309227450	1909437
BPW	0309227530	1909437
BPW	0309227540	1909439
BPW	0309227550	1909440
BPW	0309227630	1909439
BPW	0309227650	1909437
BPW	0309227710	1909437
BPW	0309227720	1909439
BPW	0309227730	1909440
BPW	0309227740	1909439
BPW	0309227750	1909437
BPW	0309227750	1909442
BPW	0309227760	1909437
BPW	0309227770	1909439
BPW	0309227780	1909440
BPW	0309227810	1909439
BPW	0309227900	1919201
BPW	0309227950	1909437
BPW	0309228010	1959112
BPW	0309228020	1959111
BPW	0309228030	1959112
BPW	0309228210	1959111
BPW	0309228220	1959112
BPW	0309228280	1959111
BPW	0309228290	1959112
BPW	0309228310	1959111
BPW	0309228320	1959111
BPW	0309228330	1959112
BPW	0309229020	1737707
BPW	0309229030	17492xx
BPW	0309229080	1737708
BPW	0309229090	17773xx
BPW	0309229350	1737707
BPW	0309229360	1737707
BPW	0309229370	1737708

Les correspondances de références ont pour seul objectif d'aider la recherche de référence

Cross references are there for the sole purpose of helping the reference search

CORRESPONDANCE DES REFERENCES CROSS REFERENCE LIST

MARQUE	REF OES	REFERENCE
BPW	0309229390	1737707
BPW	0309229430	1737707
BPW	0309229440	1737707
BPW	0309229450	1737708
BPW	0309229490	1737708
BPW	0309229520	1737707
BPW	0309229530	1737707
BPW	0309229540	1737708
BPW	0309229560	1737708
BPW	0309229600	1908101
BPW	0309229610	1908101
BPW	0309229640	1740501
BPW	0309229650	1740501
BPW	0309230010	19005xx
BPW	0309235070	17415xx
BPW	0309235080	19576xx
BPW	0309235090	19575xx
BPW	0309235300	19602xx
BPW	0392279800	1919201
BPW	0509126900	1903230
BPW	0509126950	1903230
BPW	0509127710	1909437
BPW	0509127750	1909437
BPW	0509127790	1909437
BPW	0509127820	1909470
BPW	0509146090	1903230
BPW	0509146090	1903270
BPW	0509146140	1903271
BPW	0509146321	1919101
BPW	0980107390	1919101
BPW	0980107410	1919101
BPW	0980107450	1919201
BPW	309214130	1957425
BPW	309214280	1957425
BPW	309214340	1957425
BPW	309214460	1957425
CARDI	18005204	1909437
COLAERT ADR	734JB01	57251001561
COLAERT ADR	734KB01	57250001561
COLAERT ADR	734PA01	59335001561
COLAERT ADR	734VA01	17016301561
COLAERT ADR	9FC314-GUARN	57248001561
DAF	0313741	1783102
DAF	0313742	1783102
DAF	0313743	1782704
DAF	0313744	1782704
DAF	0313745	1962005
DAF	0313746	1782704
DAF	0313746	1962004

MARQUE	REF OES	REFERENCE
DAF	0389862	RES005
DAF	0391951	1991403
DAF	0607360	1782704
DAF	0607855	1962004
DAF	0607991	CR0936
DAF	0607992	CR0937
DAF	0607993	CR0932
DAF	0607994	CR0933
DAF	0608422	CR0928
DAF	0608423	CR0929
DAF	0608424	CR0940
DAF	0608425	CR0941
DAF	0608438	1782704
DAF	0608438	1783102
DAF	0608505	1782704
DAF	0680815	1925602
DAF	0680816	1925602
DAF	0680841	1925602
DAF	0680842	1925602
DAF	0680883	1925602
DAF	0681272	1726301
DAF	0681274	1915002
DAF	0681276	1915002
DAF	0681278	1925602
DAF	0681284	1925602
DAF	0681473	1991403
DAF	0681474	1991403
DAF	0681516	1990002
DAF	0681518	1990004
DAF	0681535	1991403
DAF	0681536	1991403
DAF	0681539	1991403
DAF	0681540	1991403
DAF	0681788	1915002
DAF	0681788T	1915002
DAF	0681790	1925602
DAF	0681790T	1925602
DAF	0682037	1915002
DAF	0682083	1991403
DAF	0682087	1991403
DAF	0682087T	1991403
DAF	0682089	1991403
DAF	0682092	1988802
DAF	0682096	1988802
DAF	0682098	1988802
DAF	0682101	1989002
DAF	0682102	1989004
DAF	0682105	1989002
DAF	0682106	1989004

Les correspondances de références ont pour seul objectif d'aider la recherche de référence

Cross references are there for the sole purpose of helping the reference search

CORRESPONDANCE DES REFERENCES CROSS REFERENCE LIST

MARQUE	REF OES	REFERENCE
DAF	0682107	1989002
DAF	0682108	1990002
DAF	0682109	1990004
DAF	0682110	1990002
DAF	0682114	1990002
DAF	0682116	1990002
DAF	0682416	1901005
DAF	0682417	1901006
DAF	0682418	1901005
DAF	0682419	1901006
DAF	0682421	1905201
DAF	0682426	1906303
DAF	0682427	1906304
DAF	0682428	1906304
DAF	0682441	1902401
DAF	0682443	1902401
DAF	0682806	1726301
DAF	0682807	1915002
DAF	0682808	1915002
DAF	0682809	1925602
DAF	0682831	1906901
DAF	0682833	17383xx
DAF	0682835	17324xx
DAF	0682837	1726301
DAF	0682839	1915002
DAF	0682839T	1915002
DAF	0682841	1925602
DAF	0682843	1961705
DAF	0682845	1990002
DAF	0682845T	1990002
DAF	0682846	1990004
DAF	0682847	1988802
DAF	0682848	1988804
DAF	0682849	1989002
DAF	0682849T	1989002
DAF	0682850	1989004
DAF	0682850T	1989004
DAF	0682851	1991403
DAF	0682852	1991404
DAF	0682853	17012xx
DAF	0682855	1902401
DAF	0682857	1901005
DAF	0682858	1901006
DAF	0682859	1905201
DAF	0682861	1906303
DAF	0682862	1906304
DAF	0682863	1906901
DAF	0683007	1906303
DAF	0683011	1726301

MARQUE	REF OES	REFERENCE
DAF	0683013	1915002
DAF	0683016	1925602
DAF	0683018	1961705
DAF	0683018	19618xx
DAF	0683021	1990002
DAF	0683022	1990004
DAF	0683023	1988802
DAF	0683024	1988804
DAF	0683025	1989002
DAF	0683026	1989004
DAF	0683027	1991403
DAF	0683028	1991404
DAF	0683029	17012xx
DAF	0683031	1902401
DAF	0683033	1901005
DAF	0683034	1901006
DAF	0683035	1905201
DAF	0683037	1906303
DAF	0683038	1906304
DAF	0683039	1906901
DAF	0683063	17383xx
DAF	0683065	17324xx
DAF	0683262	1915002
DAF	0683263	1915002
DAF	0683265	1925602
DAF	0683266	1990002
DAF	0683267	1990004
DAF	0683268	1988802
DAF	0683269	1988804
DAF	0683270	1989002
DAF	0683271	1989004
DAF	0683272	1991403
DAF	0683274	1901005
DAF	0683275	1901006
DAF	0683276	1905201
DAF	0683278	1906303
DAF	0683279	1906304
DAF	0683280	1906901
DAF	0683313	1961705
DAF	0683317	1902401
DAF	0683390	1726301
DAF	0699152	CR0928
DAF	0699153	CR0929
DAF	0699154	CR0932
DAF	0699155	CR0933
DAF	0699156	CR0940
DAF	0699157	CR0941
DAF	0699158	CR0936
DAF	0699159	CR0937

Les correspondances de références ont pour seul objectif d'aider la recherche de référence

Cross references are there for the sole purpose of helping the reference search

CORRESPONDANCE DES REFERENCES CROSS REFERENCE LIST

MARQUE	REF OES	REFERENCE
DAF	070707	1901005
DAF	070708	1901005
DAF	0867623	ECF003
DAF	1212994	RES005
DAF	1246532	MAC9063/64
DAF	1301490	RES005
DAF	1505365	ECF001
DAF	1505891	RES011
DAF	1518452	ECF002
DAF	1518456	ECF004
DAF	1522138	1907102
DAF	1694347	AC0009
DAF	1694352	AC0005
DAF	1694353	AC0006
DAF	1694354	AC0014
DAF	1694355	AC0007
DAF	1694361	MAC9071/2
DAF	1694362	AC0013
DAF	1694363	AC0016
DAF	1694368	AC0001
DAF	1694372	AC0015
DAF	1694793	AC0010
DAF	1694794	AC0011
DAF	1696640	CAM005
DAF	1696641	CAM006
DAF	1696642	CAM007
DAF	1696643	CAM008
DAF	1785123	1905201
DAF	1785124	1905201
DAF	1785125	1906303
DAF	1785126	1906303
DAF	1806639	1906303
DAF	1808124	1901005
DAF	1808125	1901006
DAF	1808126	1905201
DAF	1808127	1905201
DAF	1808128	1906304
DAF	1808130	1906901
DAF	1808184	1989004
DAF	391156	MAC9063/64
DAF	702971	1909437
DAF	91112875	MF0503
DAF	AMPA951	1581702
DAF	BB7847F8	1581702
DAF	FBU9121	ECF001
DAF	GWC1149	CR1002
DAF	RTC3624	CR1002
DAF	SR3157755	MF0407
DAF LDV	759704	CR1003

MARQUE	REF OES	REFERENCE
DEMAG	40008412	RES012
DEMAG	40030412	19687001549
DEMAG	40030512	19690001549
DEMAG	40039712	19041001549
DEMAG	40076112	19041001549
DEMAG	40106112	19042001549
DEMAG	40106412	19723001549
DEMAG	40106612	17374001549
DEMAG	40108012	19723001549
DEMAG	76234073	ECF004
DEMAG	76234173	ECF003
DEMAG	95537700	RES010
DEMAG	96851600	RES011
DENNIS	65481213	ECF001
EVOBUS	82820007250	RES010
FAUN	8412197	19687001549
FAUN	99700916125	RES010
FAUN	99704921121	19690001549
FAUN	99704921123	19687001549
FAUN	99707007751	19041001549
FAUN	99707007754	19042001549
FAUN	99707303767	ECF003
FAUN	99707305564	ECF004
FAUN	99707306795	RES012
FAUN	99708412185	RES011
FERODO	FAI200	98016800
FERODO	FAI201	98016900
FERODO	FAI202	98017002
FERODO	FAI203	98017102
FERODO	FAI205	98023500
FERODO	FAI206	98023600
FERODO	FAI207	98032200
FERODO	FAI208	98032100
FERODO	FK00620.0	1961370
FERODO	FK00620.1	1961371
FERODO	FK00622.0	1955770
FERODO	FK00622.1	1955771
FERODO	FK19030.0	1903070
FERODO	FK19032.9	1903270
FERODO	FK19033.9	1928370
FERODO	FK19036.0	1903770
FERODO	FK19036.1	1903771
FERODO	FK19094.9	1909470
FERODO	FK19095.9	1947770
FERODO	FK19369.0	1936970
FERODO	FK19369.1	1936971
FERODO	FK19604.0	1960470
FERODO	FK19604.1	1960471
FERODO	FK19762.0	1976270

Les correspondances de références ont pour seul objectif d'aider la recherche de référence

Cross references are there for the sole purpose of helping the reference search

CORRESPONDANCE DES REFERENCES CROSS REFERENCE LIST

MARQUE	REF OES	REFERENCE
FERODO	FK19862.0	1960870
FERODO	FK19908.0	1990870
FERODO	FK19908.1	1990871
FERODO	FK89032.9	1903271
FERODO	FK89094.9	1909471
FERODO	K00235.0	16070xx
FERODO	K00351.0	19709xx
FERODO	K00351.1	19709xx
FERODO	K00392.0	18014xx
FERODO	K00620.0	1961313
FERODO	K00620.1	1961314
FERODO	K00622.0	1955713
FERODO	K00622.1	1955714
FERODO	K00676.0	17372xx
FERODO	K0N305.0	16066xx
FERODO	K13532.0	1302001
FERODO	K15207.0	15207xx
FERODO	K15349.0	1534906
FERODO	K15349.1	1534907
FERODO	K15494.0	15494xx
FERODO	K15580.2	1558008
FERODO	K15580.3	15580xx
FERODO	K15698.0	15698xx
FERODO	K15732.0	1573204
FERODO	K15732.1	1573205
FERODO	K15742.0	1503002
FERODO	K15742.1	1503003
FERODO	K15817.0	1581702
FERODO	K15869.0	1505901
FERODO	K15879.0	1587906
FERODO	K15879.1	1587907
FERODO	K17016.0	1700101
FERODO	K17016.1	1700102
FERODO	K17017.0	1701703
FERODO	K17017.1	1701704
FERODO	K17094.0	1709401
FERODO	K17096.0	1709601
FERODO	K17217.0	17217xx
FERODO	K17229.0	17229xx
FERODO	K17316.0	17316xx
FERODO	K17357.0	17357xx
FERODO	K17357.1	17357xx
FERODO	K17408.0	1740805
FERODO	K17408.1	1740806
FERODO	K17409.0	1740910
FERODO	K17409.2	1740909
FERODO	K17409.3	17409xx
FERODO	K17456.0	1745605
FERODO	K17481.0	1748107

MARQUE	REF OES	REFERENCE
FERODO	K17482.0	1748206
FERODO	K17497.0	17497xx
FERODO	K17546.0	17546xx
FERODO	K17555.0	17555xx
FERODO	K17557.0	17557xx
FERODO	K17635.0	1708802
FERODO	K17635.1	1708804
FERODO	K17688.0	17879xx
FERODO	K17792.0	17792xx
FERODO	K17804.1	17804xx
FERODO	K17827.0	1782704
FERODO	K17869.0	17869xx
FERODO	K17880.0	17880xx
FERODO	K17885.0	17885xx
FERODO	K17900.0	1790007
FERODO	K17924.0	1792408
FERODO	K17924.1	1792409
FERODO	K17928.3	1728006
FERODO	K17929.3	1728705
FERODO	K17932.0	17932xx
FERODO	K17942.0	17942xx
FERODO	K17973.0	1735003
FERODO	K17975.0	1735103
FERODO	K17988.0	1798806
FERODO	K17992.0	1799201
FERODO	K19010.0	1901005
FERODO	K19010.1	1901006
FERODO	K19024.0	1902401
FERODO	K19030.0	1903001
FERODO	K19032.0	1903230
FERODO	K19032.1	1903231
FERODO	K19032.2	19032xx
FERODO	K19036.0	1903712
FERODO	K19036.1	1903713
FERODO	K19037.0	1903616
FERODO	K19037.1	1903617
FERODO	K19049.0	1904902
FERODO	K19049.1	1904911
FERODO	K19052.0	1905201
FERODO	K19052.1	19052xx
FERODO	K19063.0	1906303
FERODO	K19063.1	1906304
FERODO	K19068.0	1906802
FERODO	K19068.1	1906805
FERODO	K19069.0	1906901
FERODO	K19071.0	1907102
FERODO	K19071.1	1907105
FERODO	K19075.0	1907502
FERODO	K19075.1	19075xx

Les correspondances de références ont pour seul objectif d'aider la recherche de référence

Cross references are there for the sole purpose of helping the reference search

CORRESPONDANCE DES REFERENCES CROSS REFERENCE LIST

MARQUE	REF OES	REFERENCE
FERODO	K19090.0	1909002
FERODO	K19090.1	1909005
FERODO	K19091.0	1909102
FERODO	K19091.1	19091xx
FERODO	K19094.0	1909437
FERODO	K19094.1	1909439
FERODO	K19099.0	1909902
FERODO	K19099.1	19099xx
FERODO	K19109.0	1910902
FERODO	K19109.1	1910903
FERODO	K19116.0	1911602
FERODO	K19116.1	19116xx
FERODO	K19150.0	1915002
FERODO	K19150.1	19150xx
FERODO	K19177.0	1917705
FERODO	K19187.0	1918702
FERODO	K19187.1	1918704
FERODO	K19187.2	19187xx
FERODO	K19191.0	1919101
FERODO	K19191.1	1919102
FERODO	K19192.0	1919201
FERODO	K19192.1	1919202
FERODO	K19231.0	19306xx
FERODO	K19255.0	1925501
FERODO	K19255.1	1925502
FERODO	K19256.0	1925602
FERODO	K19262.0	1934202
FERODO	K19263.0	1934302
FERODO	K19263.1	1934304
FERODO	K19283.0	1928308
FERODO	K19283.1	1928309
FERODO	K19351.0	19351xx
FERODO	K19365.0	1936605
FERODO	K19365.1	1936607
FERODO	K19366.0	1936515
FERODO	K19366.1	1936513
FERODO	K19369.0	1936912
FERODO	K19369.0	1936970
FERODO	K19369.1	1936913
FERODO	K19369.2	1936914
FERODO	K19385.0	1938414
FERODO	K19385.1	1938415
FERODO	K19393.0	1939302
FERODO	K19393.1	1939304
FERODO	K19410.0	1941001
FERODO	K19477.0	1947706
FERODO	K19477.1	1947707
FERODO	K19480.0	1947905
FERODO	K19480.1	19479xx

MARQUE	REF OES	REFERENCE
FERODO	K19486.0	1949402
FERODO	K19486.1	1949404
FERODO	K19487.0	1949502
FERODO	K19487.1	1949504
FERODO	K19488.0	1949602
FERODO	K19488.1	1949604
FERODO	K19492.0	19492xx
FERODO	K19492.1	19492xx
FERODO	K19503.0	1950308
FERODO	K19503.1	1950307
FERODO	K19515.0	1951512
FERODO	K19542.0	1954201
FERODO	K19542.1	19542xx
FERODO	K19553.0	1955301
FERODO	K19553.1	19553xx
FERODO	K19555.0	1955502
FERODO	K19555.1	19555xx
FERODO	K19562.0	1956202
FERODO	K19562.1	1956204
FERODO	K19573.0	1957306
FERODO	K19574.0	1957427
FERODO	K19579.0	1970601
FERODO	K19579.1	1970618
FERODO	K19581.0	1970701
FERODO	K19581.1	1970702
FERODO	K19604.0	1960408
FERODO	K19604.1	1960409
FERODO	K19617.0	19618xx
FERODO	K19620.0	1962004
FERODO	K19648.0	19648xx
FERODO	K19657.0	1946301
FERODO	K19657.1	19463xx
FERODO	K19694.0	19694xx
FERODO	K19700.0	19700xx
FERODO	K19708.0	1970803
FERODO	K19714.0	1971401
FERODO	K19714.2	1971403
FERODO	K19716.0	1971613
FERODO	K19716.1	1971602
FERODO	K19718.0	1971802
FERODO	K19758.0	1975803
FERODO	K19762.0	1976210
FERODO	K19762.1	1976211
FERODO	K19799.0	1979901
FERODO	K19821.0	19821xx
FERODO	K19823.0	1978611
FERODO	K19824.0	1982410
FERODO	K19844.3	1950607
FERODO	K19844.4	1950608

Les correspondances de références ont pour seul objectif d'aider la recherche de référence

Cross references are there for the sole purpose of helping the reference search

CORRESPONDANCE DES REFERENCES CROSS REFERENCE LIST

MARQUE	REF OES	REFERENCE
FERODO	K19847.0	1969905
FERODO	K19858.0	19858xx
FERODO	K19862.0	1986201
FERODO	K19877.0	1987701
FERODO	K19879.0	19880xx
FERODO	K19890.0	1989002
FERODO	K19890.1	1989004
FERODO	K19892.0	1989208
FERODO	K19892.1	1989202
FERODO	K19896.0	19896xx
FERODO	K19896.1	19896xx
FERODO	K19900.0	1990002
FERODO	K19900.1	1990004
FERODO	K19902.0	1990210
FERODO	K19902.1	1990212
FERODO	K19908.0	1990803
FERODO	K19908.1	1990804
FERODO	K19912.0	1991201
FERODO	K19914.0	1991403
FERODO	K19918.0	1922507
FERODO	K19921.0	1992101
FERODO	K19928.0	1992802
FERODO	K19931.0	1993101
FERODO	K19931.1	1993102
FERODO	K19931.2	19931xx
FERODO	K19932.0	1993201
FERODO	K19932.1	1993202
FERODO	K19932.2	19932xx
FERODO	K19933.0	1993301
FERODO	K19933.1	1993307
FERODO	K19934.0	1993402
FERODO	K19934.1	1993410
FERODO	K19935.0	1993502
FERODO	K19935.1	1993514
FERODO	K19935.2	19935xx
FERODO	K19941.0	1994102
FERODO	K19941.1	19941xx
FERODO	K19952.0	1995201
FERODO	K19972.2	1997201
FORD	1560032	CR1002
FORD	4055730	CR0618
FORD	92VB2261CA	CR0618
GIGANT SAE	7802022	1976210
GIGANT SAE	8803050	1976211
GIGANT SAE	8803051	1976210
GIGANT SAE	9012303	1976210
GIGANT SAE	9104160	1976210
GIGANT SAE	9317084	1957471
GIGANT SAE	9317087	1990212

MARQUE	REF OES	REFERENCE
GIGANT SAE	9317804	1976270
GROVE	03322163	19687001549
GROVE	1066769	RES011
GROVE	1201546	RES010
GROVE	2214701	19690001549
GROVE	2217654	19687001549
GROVE	2310563	ECF003
GROVE	2312231	ECF004
GROVE	3316914	17374001549
GROVE	3322113	19041001549
GROVE	3322117	17374001549
GROVE	3329898	19113001549
GROVE	9049991012	19687001549
GROVE	9049991254	19723001549
GROVE	9049991834	19687001549
IRISBUS	500359913	FCS003
IRISBUS	500359916	FCS004
IRISBUS	5006015979	1907180
IRISBUS	5006018433	CAM001
IRISBUS	5006018434	CAM002
IRISBUS	5006018435	AC0009
IRISBUS	5006018436	AC0012
IRISBUS	5006018437	AC0006
IRISBUS	5006018438	AC0005
IRISBUS	5006018439	AC0014
IRISBUS	5006018440	AC0007
IRISBUS	5006018455	AC0016
IRISBUS	5006018458	AC0001
IRISBUS	5006018471	AC0015
IRISBUS	5006018472	AC0003
IRISBUS	5006018473	AC0004
IRISBUS	5006018474	AC0010
IRISBUS	5006018475	AC0011
IRISBUS	5006018479	AC0008
IRISBUS	5006018480	AC0013
IVECO	1267408	17275xx
IVECO	1543999	MF0503
IVECO	1901906	1938414
IVECO	1902185	1938414
IVECO	1902483	1978610
IVECO	1903250	1709401
IVECO	1903251	17094xx
IVECO	1903253	17769xx
IVECO	1903254	1792408
IVECO	1903255	1792409
IVECO	1903256	1792409
IVECO	1903257	1740805
IVECO	1903258	1740806
IVECO	1903259	1573205

Les correspondances de références ont pour seul objectif d'aider la recherche de référence

Cross references are there for the sole purpose of helping the reference search

CORRESPONDANCE DES REFERENCES CROSS REFERENCE LIST

MARQUE	REF OES	REFERENCE
IVECO	1903260	1573206
IVECO	1903261	1708802
IVECO	1903262	1708804
IVECO	1903263	1708804
IVECO	1903284	1768801
IVECO	1903285	17688xx
IVECO	1903287	19821xx
IVECO	1903288	19821xx
IVECO	1903290	17688xx
IVECO	1903306	1962004
IVECO	1903315	19153xx
IVECO	1903333	17300xx
IVECO	1903334	17300xx
IVECO	1903342	17275xx
IVECO	1903359	1978610
IVECO	1903360	1978612
IVECO	1903378	1962005
IVECO	1903379	1962005
IVECO	1903382	1962004
IVECO	1903480	1938414
IVECO	1903481	1938415
IVECO	1903490	1708804
IVECO	1903491	19224xx
IVECO	1906000	1922507
IVECO	1906027	1503002
IVECO	1906028	1503003
IVECO	1906032	1938478S
IVECO	1906033	1938415
IVECO	1906035	19225xx
IVECO	1906055	1792409
IVECO	1906065	1503002
IVECO	1906066	1503003
IVECO	1906067	1503003
IVECO	1906068	1792409
IVECO	1906069	1792410
IVECO	1906076	1708804
IVECO	1906077	1708806
IVECO	1906083	19622xx
IVECO	1906085	17275xx
IVECO	1906087	1978610
IVECO	1906088	1978612
IVECO	1906100	19622xx
IVECO	1906103	17269xx
IVECO	1906105	1982410
IVECO	1906113	1962004
IVECO	1906115	1962004
IVECO	1906117	1782704
IVECO	1906124	17269xx
IVECO	1906132	1768801

MARQUE	REF OES	REFERENCE
IVECO	1906136	1783102
IVECO	1906137	17831xx
IVECO	1906142	1962005
IVECO	1906143	1962005
IVECO	1906149	1782705
IVECO	1906150	1962005
IVECO	1906161	17993xx
IVECO	1906162	17993xx
IVECO	1906163	17993xx
IVECO	1906164	19622xx
IVECO	1906165	19622xx
IVECO	1906171	MF0503
IVECO	1906176	1938414
IVECO	1906177	1938415
IVECO	1906197	1709601
IVECO	1906198	17096xx
IVECO	1906200	1938414
IVECO	1906221	1950308
IVECO	1906222	1950307
IVECO	1906223	1950309
IVECO	1906227	1909178
IVECO	1906230	1573205
IVECO	1906232	1573206
IVECO	1906233	1740805
IVECO	1906235	1740806
IVECO	1906236	1792408
IVECO	1906237	1708802
IVECO	1906238	17098xx
IVECO	1906239	17688xx
IVECO	1906240	19821xx
IVECO	1906241	1938415
IVECO	1906244	1978610
IVECO	1906245	1978612
IVECO	1906247	1982410
IVECO	1906248	19824xx
IVECO	1906249	1982410
IVECO	1906261	1938478S
IVECO	1906265	1792409
IVECO	1906266	1792410
IVECO	1906267	1708804
IVECO	1906268	1708804
IVECO	1906269	17688xx
IVECO	1906273	19821xx
IVECO	1906301	1709401
IVECO	1906303	17094xx
IVECO	1906304	17769xx
IVECO	1906352	MF0503
IVECO	1906354	1938478S
IVECO	1906361	1950378

Les correspondances de références ont pour seul objectif d'aider la recherche de référence

Cross references are there for the sole purpose of helping the reference search

CORRESPONDANCE DES REFERENCES CROSS REFERENCE LIST

MARQUE	REF OES	REFERENCE
IVECO	1906362	19153xx
IVECO	1906363	19153xx
IVECO	1906371	1971401
IVECO	1906372	1971401
IVECO	1906373	1971403
IVECO	1906374	1971612
IVECO	1906375	1971602
IVECO	1906377	MF0525
IVECO	1906380	1503002
IVECO	1906381	1503003
IVECO	1906382	1503003
IVECO	1906397	1922507
IVECO	1906398	19225xx
IVECO	1906407	1971401
IVECO	1906408	1971403
IVECO	1906409	1971403
IVECO	1906413	1971612
IVECO	1906414	1971603
IVECO	1906414	1971614
IVECO	1906431	1971401
IVECO	1906432	1971612
IVECO	1906470	1938478S
IVECO	2966336	17300xx
IVECO	2966443	19153xx
IVECO	2966444	19153xx
IVECO	2966445	19153xx
IVECO	2966939	17248xx
IVECO	2966940	17248xx
IVECO	2967021	17300xx
IVECO	2983279	CR0932
IVECO	2983280	CR0933
IVECO	2983300	CR0928
IVECO	2983301	CR0929
IVECO	2983313	CR0936
IVECO	2983314	CR0937
IVECO	2983327	CR0940
IVECO	2983328	CR0941
IVECO	2991624	1971478
IVECO	2991627	1971401
IVECO	2991630	1971678
IVECO	2991755	1909902
IVECO	2991755	1909978
IVECO	2991756	1909902
IVECO	2991759	1909178
IVECO	2991760	1909102
IVECO	2991896	1971603
IVECO	2991906	1938414
IVECO	2991907	1938415
IVECO	2991908	1938416

MARQUE	REF OES	REFERENCE
IVECO	2991914	1971401
IVECO	2991915	1971403
IVECO	2991918	1909902
IVECO	2991919	1909902
IVECO	2992005	1909102
IVECO	2992113	1910902
IVECO	2992123	1911678
IVECO	2992124	1911603
IVECO	2992375	1910978
IVECO	2992378	1911678
IVECO	2995821	1910978NV
IVECO	2995824	1911678NV
IVECO	2996501	1911602
IVECO	2996507	1910903
IVECO	2997760	1909102
IVECO	3395088	ACK008
IVECO	3434793	19153xx
IVECO	3434795	19153xx
IVECO	4071472	CR1012
IVECO	41000936	1955301
IVECO	41022771	FCS005
IVECO	41022772	FCS006
IVECO	41022773	FCS009
IVECO	41022774	FCS010
IVECO	41025289	FCS011
IVECO	41025290	FCS012
IVECO	41211315	FCD005
IVECO	41211316	FCD006
IVECO	41211321	FCD011
IVECO	41211322	FCD012
IVECO	4122369	CR1010
IVECO	4122669	CR1010
IVECO	41285024	1911678NV
IVECO	41285034	FCD011
IVECO	41285035	FCD012
IVECO	4212449	CR1014
IVECO	4220639	CR1016
IVECO	4220643	CR1011
IVECO	42481446	1740806
IVECO	42482970	RES010
IVECO	42488204	ECF008
IVECO	42491897	1978610
IVECO	42491950	ACK009
IVECO	42491974	ACK019
IVECO	42492084	1938478S
IVECO	42499976	1573204
IVECO	42530550	98032100
IVECO	42531677	AC0029
IVECO	42532204	KTU010

Les correspondances de références ont pour seul objectif d'aider la recherche de référence

Cross references are there for the sole purpose of helping the reference search

CORRESPONDANCE DES REFERENCES CROSS REFERENCE LIST

MARQUE	REF OES	REFERENCE
IVECO	42536144	KTU011
IVECO	42536192	KRES009
IVECO	42536194	ACK013
IVECO	42537758	AC0023
IVECO	42537841	AC0028
IVECO	42537942	ACK012
IVECO	42538062	ACK021
IVECO	42538063	ACK020
IVECO	42538064	ACK004
IVECO	42538065	ACK010
IVECO	42538068	KTU013
IVECO	42539437	98032200
IVECO	42539438	KTU012
IVECO	42540290	AC0002
IVECO	4254725	CR1023
IVECO	42552777	KTU011
IVECO	42552778	KTU013
IVECO	42558429	ACK007
IVECO	42558430	ACK005
IVECO	42558432	ACK006
IVECO	42559512	ACK006
IVECO	4276036	CR1015
IVECO	4291534	CR0620
IVECO	4294681	CR1018
IVECO	4296247	CR1017
IVECO	4712856	CR1019
IVECO	4727624	CR1007
IVECO	4744164	CR1007
IVECO	4819706	ECF008
IVECO	4837192	CR0620
IVECO	4846034	FL3207
IVECO	4846035	FL3208
IVECO	4860637	FCD003
IVECO	4860638	FCD004
IVECO	500300073	FL3001
IVECO	500300075	FL3002
IVECO	500351600	FCS001
IVECO	500351601	FCS002
IVECO	5006018456	AC0002
IVECO	503532556	ACK014
IVECO	60102882	CR0620
IVECO	7160118	17769xx
IVECO	7160125	17769xx
IVECO	7160129	1709401
IVECO	7160132	17094xx
IVECO	7160138	1740806
IVECO	7160140	1740806
IVECO	7160141	1740807
IVECO	7160149	1573205

MARQUE	REF OES	REFERENCE
IVECO	7160151	1573205
IVECO	7160152	1573206
IVECO	7160154	1573205
IVECO	7160156	1573205
IVECO	7160157	1573206
IVECO	7160171	1708802
IVECO	7160173	1708804
IVECO	7160174	1708806
IVECO	7160175	1708802
IVECO	7160177	1708804
IVECO	7160178	1708806
IVECO	7162112	TF0014
IVECO	7165213	CR1011
IVECO	7165225	1792408
IVECO	7165227	1792408
IVECO	7165379	TF0014
IVECO	7165802	CR1023
IVECO	7165992	1978612
IVECO	7167704	1792410
IVECO	7167705	1792409
IVECO	7167707	1792410
IVECO	7169839	19821xx
IVECO	7170420	ECF008
IVECO	7910200	TF0014
IVECO	7980404	ACK009
IVECO	7980405	ACK015
IVECO	7980406	ACK016
IVECO	7980407	ACK011
IVECO	7980408	ACK014
IVECO	7980525	CR1002
IVECO	7980687	ACK002
IVECO	7984278	CR0414
IVECO	8121104	CR0414
IVECO	8121575	CR1002
IVECO	8121576	CR1003
IVECO	8123580	CR0420
IVECO	8123712	ECF008
IVECO	8124934	KRES011
IVECO	8193387	CR1020
IVECO	8193797	CR0928
IVECO	8193798	CR0929
IVECO	8193799	CR0932
IVECO	8193800	CR0933
IVECO	8193801	CR0940
IVECO	8193802	CR0941
IVECO	8193803	CR0936
IVECO	8193804	CR0937
IVECO	8194527	CR0420
IVECO	8559394	1740805

Les correspondances de références ont pour seul objectif d'aider la recherche de référence

Cross references are there for the sole purpose of helping the reference search

CORRESPONDANCE DES REFERENCES CROSS REFERENCE LIST

MARQUE	REF OES	REFERENCE
IVECO	93155720	CR0420
IVECO	93155721	CR1020
IVECO	93155722	CR0414
IVECO	93159002	CR1005
IVECO	93160540	CR1005
IVECO	93161254	CAC038
IVECO	93161256	CAC037
IVECO	93161353	ACK011
IVECO	93161621	ACK008
IVECO	93161622	ACK005
IVECO	93161623	ACK007
IVECO	93161626	ACK003
IVECO	93161627	KRES010
IVECO	93161768	CAC036
IVECO	93161863	AC0036
IVECO	93161864	AC0037
IVECO	93161872	KRES008
IVECO	93161954	KRES007
IVECO	93162113	KRES010
IVECO	93162114	ACK005
IVECO	93163355	ECF002
IVECO	93163525	ECF001
IVECO	93191114	98032100
IVECO	93192154	ECF008
IVECO	93192155	ECF007
IVECO	93192584	KTU010
IVECO	93192921	98032200
IVECO	93193778	KTU012
IVECO	98449332	FL3207
IVECO	98449334	FL3208
IVECO	98452387	CR1006
IVECO	98464849	FCD003
IVECO	98464850	FCD004
IVECO	98474483	FCS001
IVECO	98474485	FCS002
IVECO	99436612	FL3207
IVECO	99436613	FL3208
IVECO	9983470	CR1002
IVECO	9983871	CR1003
KÄSSBOHRER	8241016237	1909437
KÄSSBOHRER	8241999325	1909437
KÄSSBOHRER	8241999326	1909439
KÄSSBOHRER	8241999328	1903230
KÄSSBOHRER	8241999329	1903231
KÄSSBOHRER	8241999686	1957422
KÄSSBOHRER	8241999721	1995201
KÄSSBOHRER	8241999722	1995201
KÄSSBOHRER	8241999733	1903230
KÄSSBOHRER	8241999734	1903231

MARQUE	REF OES	REFERENCE
KÄSSBOHRER	8241999735	1909437
KÄSSBOHRER	8241999736	1909439
KÄSSBOHRER	8241999923	1903232
KÄSSBOHRER	8241999925	1909440
KÄSSBOHRER	8282000491	1740805
KÄSSBOHRER	8282000539	1740806
KÄSSBOHRER	82820009610	1740806
KÄSSBOHRER	82820009700	1740805
KÄSSBOHRER	82820009780	1740805
KÄSSBOHRER	8283000649	1974302
KÄSSBOHRER	8283000651	1974302
KÄSSBOHRER	8283000769	1916602
KÄSSBOHRER	8283000770	1916602
KÄSSBOHRER	8285000064	1956801
KÄSSBOHRER	8285000147	1956802
KÄSSBOHRER	8285000227	1916602
KÄSSBOHRER	8285000228	1916602
KÄSSBOHRER	8285000241	1916603
KÄSSBOHRER	8285000242	1916603
KÄSSBOHRER	8285066060	1969905
KÄSSBOHRER	8285079349	17742xx
KÄSSBOHRER	8285079350	17742xx
KÄSSBOHRER	8285196110	1984906
KÄSSBOHRER	8285196111	1984906
KÄSSBOHRER	8285196112	19849xx
KÄSSBOHRER	8285196113	19849xx
KÄSSBOHRER	8285200114	1969905
KÄSSBOHRER	8285200115	1969905
KÄSSBOHRER	8285200116	1969905
KÄSSBOHRER	8285200117	1969906
KÄSSBOHRER	8285200118	1969906
KÄSSBOHRER	8285232219	1984906
KÄSSBOHRER	8285232220	19849xx
KÄSSBOHRER	8285232221	1984906
KÄSSBOHRER	8285232222	19849xx
KÄSSBOHRER	8285232314	19849xx
KÄSSBOHRER	8285232315	19849xx
KÄSSBOHRER	82852325220	1969906
KÄSSBOHRER	8285232523	1969905
KÄSSBOHRER	8285236223	1969905
KÄSSBOHRER	8285236224	1969906
KÄSSBOHRER	8285236225	1969905
KÄSSBOHRER	8285236226	1969906
KÄSSBOHRER	8285236312	1969906
KÄSSBOHRER	8285236313	1969906
KÄSSBOHRER	8285345369	1969905
KÄSSBOHRER	8285345370	1969905
KÄSSBOHRER	8285348407	1985502
KÄSSBOHRER	8285348408	1985502

Les correspondances de références ont pour seul objectif d'aider la recherche de référence

Cross references are there for the sole purpose of helping the reference search

CORRESPONDANCE DES REFERENCES CROSS REFERENCE LIST

MARQUE	REF OES	REFERENCE
KÄSSBOHRER	8285348409	19855xx
KÄSSBOHRER	8285348410	19855xx
KÄSSBOHRER	8285350373	1984906
KÄSSBOHRER	8285350374	1984906
KÄSSBOHRER	8285364377	1984906
KÄSSBOHRER	8285364378	1984906
KÄSSBOHRER	8285364379	19849xx
KÄSSBOHRER	8285364380	19849xx
KÄSSBOHRER	8285368361	1969905
KÄSSBOHRER	8285368362	1969905
KÄSSBOHRER	8285368363	1969906
KÄSSBOHRER	8285368364	1969906
KÄSSBOHRER	82855066040	1969906
KÄSSBOHRER	82855086030	1969906
KESSLER	10070501	19113001549
KNOTT	104674.002	ECF005
KNOTT	104674.003	ECF006
KNOTT	24500	ECF005
KNOTT	24501	ECF006
KNOTT	31894	13016xx
KNOTT	31894S02	13016xx
KNOTT	3214601	15304xx
KNOTT	32339	11287xx
KNOTT	32339S02	11287xx
KNOTT	3441517	1971201
KNOTT	34545S02	15046xx
KNOTT	35023	11556xx
KNOTT	35131S02	13016xx
KNOTT	35224S02	11637xx
KNOTT	356501	15839xx
KNOTT	35962S02	11037xx
KNOTT	44692	11037xx
KNOTT	6435296	13013xx
KOGEL	189242	ECF002
KOGEL	1892420	ECF002
KRUPP	1070495	19687001549
LEYLAND DAF	AMPB017	1950308
LEYLAND DAF	AMPB018	1950308
LEYLAND DAF	AMPB288	1790006
LEYLAND DAF	AMPB289	1581702
LEYLAND DAF	AMPB294	1581702
LEYLAND DAF	AMPB295	1790006
LIEBHERR	502209108	17237001549
LIEBHERR	530050008	19687001549
LIEBHERR	571371008G	ECF004
LIEBHERR	571632408	19041001549
LIEBHERR	571633208	17374001549
LIEBHERR	571644808	19042001549
LIEBHERR	571739308	19041001549

MARQUE	REF OES	REFERENCE
LIEBHERR	571740708	19042001549
LIEBHERR	571740808	19042001549
LIEBHERR	571833908	19723001549
LIEBHERR	571838208	17374001549
MAGIRUS	2560503E510712	1740805
MAGIRUS	2966745E510712	1740806
MAGIRUS	42481444	1740805
MAGIRUS	42481445	1740805
MAGIRUS	42481446	1740806
MAN	36504556002	ECF003
MAN	81259370021	98023500
MAN	81259370022	98023600
MAN	81259370026	98023500
MAN	81259370027	98023600
MAN	81259370028	98023500
MAN	81259370029	98023600
MAN	81259370031	98023600
MAN	81259370032	98023500
MAN	81259370033	98023500
MAN	81259370034	98023600
MAN	81259376011	98023500
MAN	81259376012	98023600
MAN	81259376021	98023500
MAN	81500006230	ECF009
MAN	81500006242	ECF009
MAN	81502006504	MAC9496CAST
MAN	81502006752	1949504
MAN	81502006783	1971302
MAN	81502006828	1949602
MAN	81502006829	1949504
MAN	81502006842	1723804
MAN	81502007231	MAC9496CAST
MAN	81502010107	MAC9496CAST
MAN	81502016070	1917705
MAN	81502016086	MAC9495CAST
MAN	81502016099	MAC9495CAST
MAN	81502016114	MAC9496CAST
MAN	81502016115	MAC9496CAST
MAN	81502016184	MAC9495CAST
MAN	81502016185	MAC9496CAST
MAN	81502016218	MAC9496CAST
MAN	81502016220	MAC9495CAST
MAN	81502016221	MAC9496CAST
MAN	81502016222	MAC9495CAST
MAN	81502016223	MAC9496CAST
MAN	81502120032	APF002
MAN	81502120036	APF002
MAN	81502130013	KRG001
MAN	81502136005	KRG001

Les correspondances de références ont pour seul objectif d'aider la recherche de référence

Cross references are there for the sole purpose of helping the reference search

CORRESPONDANCE DES REFERENCES CROSS REFERENCE LIST

MARQUE	REF OES	REFERENCE
MAN	81502136006	KRG001
MAN	81502200012	17285xx
MAN	81502200123	15136xx
MAN	81502200144	17286xx
MAN	81502200189	17702xx
MAN	81502200190	17702xx
MAN	81502200238	1949504
MAN	81502200244	17410xx
MAN	81502200245	17410xx
MAN	81502200283	1949504
MAN	81502200353	1949605
MAN	81502200398	19527xx
MAN	81502200399	19527xx
MAN	81502200431	17569xx
MAN	81502200432	17569xx
MAN	81502200434	17160xx
MAN	81502200435	17728xx
MAN	81502200436	17728xx
MAN	81502200438	1949504
MAN	81502200504	1971302
MAN	81502200505	1949504
MAN	81502200550	1949402
MAN	81502200550	1971301
MAN	81502200551	1949502
MAN	81502200629	1971302
MAN	81502200632	1949604
MAN	81502200641	1971302
MAN	81502200644	1949604
MAN	81502200647	1949604
MAN	81502200650	1971302
MAN	81502200658	1971301
MAN	81502200659	1971301
MAN	81502200660	1971301
MAN	81502200661	1949602
MAN	81502200662	1949602
MAN	81502200663	1949602
MAN	81502200711	1949505
MAN	81502200712	1949505
MAN	81502200713	1949605
MAN	81502200715	1949605
MAN	81502200717	1949605
MAN	81502200720	1949504
MAN	81502200763	1949504
MAN	81502200769	1949504
MAN	81502200907	1949504
MAN	81502200911	1949602
MAN	81502200913	1949602
MAN	81502200917	1949602
MAN	81502200995	1949402

MARQUE	REF OES	REFERENCE
MAN	81502200995	1971301
MAN	81502210003	1949602
MAN	81502210006	1790006
MAN	81502210007	17900xx
MAN	81502210009	1790006
MAN	81502210010	17900xx
MAN	81502210012	1581702
MAN	81502210013	15817xx
MAN	81502210014	15817xx
MAN	81502210015	1581702
MAN	81502210016	15817xx
MAN	81502210017	15817xx
MAN	81502210049	1768204
MAN	81502210051	17682xx
MAN	81502210056	17238xx
MAN	81502210059	1949504
MAN	81502210141	1723804
MAN	81502210142	1723802
MAN	81502210143	17238xx
MAN	81502210160	1971302
MAN	81502210165	1949604
MAN	81502210167	1949605
MAN	81502210218	1949504
MAN	81502210223	1949602
MAN	81502210235	1970702
MAN	81502210236	1970701
MAN	81502210237	1970720
MAN	81502210255	1970702
MAN	81502210256	1970701
MAN	81502210257	1970720
MAN	81502210275	1970702
MAN	81502210276	1970701
MAN	81502210277	1970720
MAN	81502210295	1970702
MAN	81502210297	1970720
MAN	81502210314	1768204
MAN	81502210315	1768202
MAN	81502210316	17682xx
MAN	81502210318	1723802
MAN	81502210319	1723802
MAN	81502210325	1970601
MAN	81502210326	1970619
MAN	81502210339	1970618
MAN	81502210340	1970601
MAN	81502210341	1970619
MAN	81502210361	1970619
MAN	81502210374	1970618
MAN	81502210375	1970601
MAN	81502210376	1970619

Les correspondances de références ont pour seul objectif d'aider la recherche de référence

Cross references are there for the sole purpose of helping the reference search

CORRESPONDANCE DES REFERENCES CROSS REFERENCE LIST

MARQUE	REF OES	REFERENCE
MAN	81502210420	1949602
MAN	81502210430	1723804
MAN	81502210431	1723802
MAN	81502210432	17238xx
MAN	81502210435	1971302
MAN	81502210436	1971301
MAN	81502210440	1949504
MAN	81502210441	1949502
MAN	81502210442	1949505
MAN	81502210443	1949505
MAN	81502210445	1949604
MAN	81502210446	1949602
MAN	81502210447	1949605
MAN	81502210450	1949504
MAN	81502210451	1949502
MAN	81502210452	1949505
MAN	81502210453	1949505
MAN	81502210485	1949602
MAN	81502210515	1723804
MAN	81502210516	1723802
MAN	81502210517	17238xx
MAN	81502210520	1971302
MAN	81502210521	1971301
MAN	81502210525	1949504
MAN	81502210526	1949502
MAN	81502210527	1949505
MAN	81502210528	1949505
MAN	81502210530	1949604
MAN	81502210531	1949602
MAN	81502210532	1949605
MAN	81502210535	1970618
MAN	81502210536	1970601
MAN	81502210537	1970619
MAN	81502210540	1970618
MAN	81502210541	1970601
MAN	81502210542	1970619
MAN	81502210545	1970702
MAN	81502210546	1970701
MAN	81502210547	1970720
MAN	81502210550	1970702
MAN	81502210551	1970701
MAN	81502210552	1970720
MAN	81502210584	1587906
MAN	81502210585	1587907
MAN	81502210586	15879xx
MAN	81502210587	1798806
MAN	81502210588	1798807
MAN	81502210589	17988xx
MAN	81502210591	1949604

MARQUE	REF OES	REFERENCE
MAN	81502210596	1949604
MAN	81502210613	1723804
MAN	81502210614	1971302
MAN	81502210615	1949504
MAN	81502210616	1701703
MAN	81502210617	1701704
MAN	81502210618	17017xx
MAN	81502210619	1917705
MAN	81502210620	19177xx
MAN	81502210623	1949604
MAN	81502210634	1723804
MAN	81502210635	1723802
MAN	81502210636	17238xx
MAN	81502210639	1971302
MAN	81502210640	1971301
MAN	81502210644	1949504
MAN	81502210645	1949502
MAN	81502210646	1949505
MAN	81502210647	1949505
MAN	81502210649	1949604
MAN	81502210650	1949602
MAN	81502210651	1949605
MAN	81502210654	1970618
MAN	81502210655	1970601
MAN	81502210656	1970619
MAN	81502210659	1970618
MAN	81502210660	1970601
MAN	81502210661	1970619
MAN	81502210664	1970702
MAN	81502210665	1970701
MAN	81502210666	1970720
MAN	81502210669	1970702
MAN	81502210670	1970701
MAN	81502210671	1970720
MAN	81502210673	1587906
MAN	81502210674	1798806
MAN	81502210675	1701703
MAN	81502210676	1917705
MAN	81502210678	1949604
MAN	81502210679	1971302
MAN	81502210680	1971301
MAN	81502210681	1949602
MAN	81502210684	1949605
MAN	81502210698	1768204
MAN	81502210700	17682xx
MAN	81502210711	1970618
MAN	81502210712	1970601
MAN	81502210713	1970619
MAN	81502210716	1970618

Les correspondances de références ont pour seul objectif d'aider la recherche de référence

Cross references are there for the sole purpose of helping the reference search

CORRESPONDANCE DES REFERENCES CROSS REFERENCE LIST

MARQUE	REF OES	REFERENCE
MAN	81502210717	1970601
MAN	81502210718	1970619
MAN	81502210721	1970702
MAN	81502210722	1970701
MAN	81502210723	1970720
MAN	81502210726	1970702
MAN	81502210727	1970701
MAN	81502210728	1970720
MAN	81502210730	1768204
MAN	81502210732	17682xx
MAN	81502210734	1587907
MAN	81502210735	15879xx
MAN	81502210736	1798807
MAN	81502210737	17988xx
MAN	81502210738	1701704
MAN	81502210739	17017xx
MAN	81502210740	19177xx
MAN	81502210743	17285xx
MAN	81502210745	15136xx
MAN	81502210746	17286xx
MAN	81502210747	17702xx
MAN	81502210748	17702xx
MAN	81502210749	17410xx
MAN	81502210750	17410xx
MAN	81502210757	19527xx
MAN	81502210758	19527xx
MAN	81502210759	17569xx
MAN	81502210760	17569xx
MAN	81502210762	17160xx
MAN	81502210763	17728xx
MAN	81502210764	17728xx
MAN	81502210768	1768202
MAN	81502210770	1949504
MAN	81502210771	1949502
MAN	81502210772	1949505
MAN	81502210773	1949505
MAN	81502210780	1949604
MAN	81502210783	1723802
MAN	81502210784	1949502
MAN	81502210785	1581702
MAN	81502210786	15817xx
MAN	81502210787	15817xx
MAN	81502210788	1581702
MAN	81502210789	15817xx
MAN	81502210790	15817xx
MAN	81502210791	1790006
MAN	81502210791	1790007
MAN	81502210792	17900xx
MAN	81502210794	1790006

MARQUE	REF OES	REFERENCE
MAN	81502210795	17900xx
MAN	81502210803	1971302
MAN	81502210804	1971301
MAN	81502210808	1949504
MAN	81502210809	1949502
MAN	81502210810	1949505
MAN	81502210811	1949505
MAN	81502210813	1949604
MAN	81502210814	1949602
MAN	81502210815	1949605
MAN	81502210817	1949604
MAN	81502210819	1949604
MAN	81502210820	1949604
MAN	81502210825	1949605
MAN	81502210829	1723804
MAN	81502210830	1723802
MAN	81502210831	17238xx
MAN	81502210834	1723804
MAN	81502210835	1723802
MAN	81502210836	17238xx
MAN	81502210839	1971302
MAN	81502210840	1971301
MAN	81502210844	1971302
MAN	81502210845	1971301
MAN	81502210849	1949504
MAN	81502210850	1949502
MAN	81502210851	1949505
MAN	81502210852	1949505
MAN	81502210854	1949504
MAN	81502210855	1949502
MAN	81502210856	1949505
MAN	81502210857	1949505
MAN	81502210859	1949604
MAN	81502210860	1949602
MAN	81502210861	1949605
MAN	81502210864	1949604
MAN	81502210865	1949602
MAN	81502210866	1949605
MAN	81502210873	1701703
MAN	81502210877	1970618
MAN	81502210878	1970601
MAN	81502210879	1970619
MAN	81502210882	1970618
MAN	81502210883	1970601
MAN	81502210884	1970619
MAN	81502210887	1970702
MAN	81502210888	1970701
MAN	81502210889	1970720
MAN	81502210892	1970702

Les correspondances de références ont pour seul objectif d'aider la recherche de référence

Cross references are there for the sole purpose of helping the reference search

CORRESPONDANCE DES REFERENCES CROSS REFERENCE LIST

MARQUE	REF OES	REFERENCE
MAN	81502210893	1970701
MAN	81502210894	1970720
MAN	81502210897	1723804
MAN	81502210898	1723802
MAN	81502210899	17238xx
MAN	81502210902	1971302
MAN	81502210903	1949402
MAN	81502210903	1971301
MAN	81502210907	1949504
MAN	81502210908	1949502
MAN	81502210909	1949505
MAN	81502210910	1949505
MAN	81502210912	1949604
MAN	81502210913	1949602
MAN	81502210914	1949605
MAN	81502210921	1949602
MAN	81502210922	1971301
MAN	81502210923	1971302
MAN	81502210926	1949604
MAN	81502210927	1949605
MAN	81502210944	1971301
MAN	81502216001	1701703
MAN	81502216003	1917705
MAN	81502216013	1587906
MAN	81502216014	1587907
MAN	81502216015	15879xx
MAN	81502216016	1798806
MAN	81502216017	1798807
MAN	81502216018	17988xx
MAN	81502216025	1701703
MAN	81502216026	1701704
MAN	81502216028	1917705
MAN	81502216029	19177xx
MAN	81502216031	1798806
MAN	81502216032	1798807
MAN	81502216033	17988xx
MAN	81502216034	1587906
MAN	81502216035	1587907
MAN	81502216036	15879xx
MAN	81502216037	1701703
MAN	81502216038	1701704
MAN	81502216039	17017xx
MAN	81502216040	1917705
MAN	81502216041	19177xx
MAN	81502216043	1798806
MAN	81502216044	1798807
MAN	81502216045	17988xx
MAN	81502216049	1917705
MAN	81502216050	19177xx

MARQUE	REF OES	REFERENCE
MAN	81502216055	1701703
MAN	81502216056	1701704
MAN	81502216057	17017xx
MAN	81502216061	1587906
MAN	81502216062	1587907
MAN	81502216063	15879xx
MAN	81502216070	1970803
MAN	81502216073	1723802
MAN	81502216074	1723804
MAN	81502216075	17238xx
MAN	81502216077	1949502
MAN	81502216078	1949504
MAN	81502216079	1949505
MAN	81502216080	1949505
MAN	81502216081	1949602
MAN	81502216082	1949604
MAN	81502216083	1949605
MAN	81502216085	1971301
MAN	81502216086	1971302
MAN	81502216089	1723802
MAN	81502216090	1723804
MAN	81502216091	17238xx
MAN	81502216093	1971301
MAN	81502216094	1971302
MAN	81502216097	1949502
MAN	81502216098	1949504
MAN	81502216099	1949505
MAN	81502216100	1949505
MAN	81502216101	1949602
MAN	81502216102	1949604
MAN	81502216103	1949605
MAN	81976100115	RES008
MAN	81976100118	RES009
MAN	81976100123	RES008
MAN	81976100208	RES009
MAN	81976100210	RES007
MAN	81976100317	RES008
MAN	88502200023	1971302
MAN	88502200024	1949604
MAN	88502200036	1971301
MAN	88502200040	1949602
MAN	88502200041	1949605
MAN	88502200044	1970618
MAN	88502200045	1970601
MAN	88502200046	1970619
MAN	88502200049	1970618
MAN	88502200050	1970601
MAN	88502200051	1970619
MAN	88502200054	1970702

Les correspondances de références ont pour seul objectif d'aider la recherche de référence

Cross references are there for the sole purpose of helping the reference search

CORRESPONDANCE DES REFERENCES CROSS REFERENCE LIST

MARQUE	REF OES	REFERENCE
MAN	88502200055	1970701
MAN	88502200056	1970720
MAN	88502200059	1970702
MAN	88502200060	1970701
MAN	88502200061	1970720
MAN	88502200064	1970618
MAN	88502200065	1970619
MAN	88502200068	1970618
MAN	88502200069	1970619
MAN	88502200072	1970702
MAN	88502200073	1970720
MAN	88502200076	1970702
MAN	88502200077	1970720
MAN	N1011014929	ECF001
MERCEDES	0004208738	ECF007
MERCEDES	0004210131	1969905
MERCEDES	00042111530	1949502
MERCEDES	0004211630	1949504
MERCEDES	0004230630	1949604
MERCEDES	0035401217	98016800
MERCEDES	0044201920	1302001
MERCEDES	0054208118	CR0581
MERCEDES	0065481213	ECF001
MERCEDES	0084202418	CR0748
MERCEDES	0084204218	CR0581
MERCEDES	0084204418	CR0748
MERCEDES	0094201118	CR0748
MERCEDES	3014211510	1970601
MERCEDES	3014211810	1779501
MERCEDES	3014212110	1779501
MERCEDES	3014215510	1779501
MERCEDES	3014215810	1779501
MERCEDES	3014218810	1779501
MERCEDES	3014231610	1949505
MERCEDES	3014231910	1949505
MERCEDES	3014234910	1970618
MERCEDES	3014235210	1970618
MERCEDES	3014236110	1970702
MERCEDES	3014236410	1970702
MERCEDES	3014237010	1970601
MERCEDES	3014237010	1970618
MERCEDES	3014237110	1970618
MERCEDES	3014237910	1970701
MERCEDES	3014238010	1970702
MERCEDES	3024232710	19466xx
MERCEDES	3024233010	19466xx
MERCEDES	3054210010	1949402
MERCEDES	3054230310	1949604
MERCEDES	3054230410	1949605

MARQUE	REF OES	REFERENCE
MERCEDES	3054230610	19466xx
MERCEDES	3054230910	1949604
MERCEDES	3054231010	1949605
MERCEDES	3054231210	19466xx
MERCEDES	3074200339	KRG001
MERCEDES	3074204002	APF002
MERCEDES	3074211210	1779501
MERCEDES	3074211510	1779501
MERCEDES	3074211610	1779501
MERCEDES	3074213610	1779501
MERCEDES	3074213910	1779501
MERCEDES	3074215410	1779501
MERCEDES	3094210410	1534906
MERCEDES	3094210510	1534907
MERCEDES	3094210710	1534906
MERCEDES	3094210810	1534907
MERCEDES	3094214910	1534906
MERCEDES	3094215210	1558008
MERCEDES	3094216710	1534906
MERCEDES	3103251300	15057xx
MERCEDES	3104213310	1558008
MERCEDES	3104214410	1558008
MERCEDES	3104215110	15057xx
MERCEDES	3144210510	15057xx
MERCEDES	3144210610	1505700928
MERCEDES	3164211910	1740909
MERCEDES	3164212310	1740909
MERCEDES	3164212410	1740909
MERCEDES	3164212510	1740909
MERCEDES	3174215610	19125xx
MERCEDES	3174232510	19466xx
MERCEDES	3174232810	19466xx
MERCEDES	3174233210	19466xx
MERCEDES	3174233510	19466xx
MERCEDES	3174235010	19466xx
MERCEDES	3184211910	1740909
MERCEDES	3244210610	15057xx
MERCEDES	3244211010	15057xx
MERCEDES	3244211410	15057xx
MERCEDES	3244211510	15057xx
MERCEDES	3244212210	1505700928
MERCEDES	3254211110	1727601
MERCEDES	3354200220	1727601
MERCEDES	3354202920	1727601
MERCEDES	3354210010	1727601
MERCEDES	3354210110	1727601
MERCEDES	3354210410	1727601
MERCEDES	3354210510	1727601
MERCEDES	3354211110	1727601

Les correspondances de références ont pour seul objectif d'aider la recherche de référence

Cross references are there for the sole purpose of helping the reference search

CORRESPONDANCE DES REFERENCES CROSS REFERENCE LIST

MARQUE	REF OES	REFERENCE
MERCEDES	3354211510	1727601
MERCEDES	3354211910	1727601
MERCEDES	3354212710	1727601
MERCEDES	3414234110	17298xx
MERCEDES	3464210010	1723802
MERCEDES	3464210110	1723804
MERCEDES	3464230010	1949502
MERCEDES	3464230110	1949505
MERCEDES	3464230310	1949402
MERCEDES	3464230310	1949404
MERCEDES	3464230610	1949502
MERCEDES	3464230710	1949505
MERCEDES	3464230810	1949505
MERCEDES	3464230910	1949502
MERCEDES	3464231010	1949505
MERCEDES	3464231210	1949404
MERCEDES	3464231910	1723802
MERCEDES	3464232010	1723804
MERCEDES	3464232210	1723802
MERCEDES	3464232310	1723804
MERCEDES	3464232510	1723802
MERCEDES	3464232610	1723804
MERCEDES	3464232810	1949502
MERCEDES	3464232910	1949505
MERCEDES	3464233110	1949402
MERCEDES	3464233410	1949502
MERCEDES	3464233510	1949505
MERCEDES	3464233710	1949402
MERCEDES	3464234010	1949402
MERCEDES	3464234110	1723802
MERCEDES	3464234210	1723804
MERCEDES	3464234310	1723802
MERCEDES	3464234610	1723802
MERCEDES	3464234810	1949502
MERCEDES	3464235510	1723802
MERCEDES	3464235710	1949502
MERCEDES	3464235810	1949404
MERCEDES	3464236710	1723802
MERCEDES	3464237110	1949505
MERCEDES	3464237410	1949505
MERCEDES	3464238310	1949505
MERCEDES	3464238610	1949505
MERCEDES	3464239410	1723802
MERCEDES	3464239510	1723802
MERCEDES	3464239610	1949502
MERCEDES	3464239710	1949502
MERCEDES	3469930210	RES009
MERCEDES	3469930310	RES008
MERCEDES	3469930810	RES007

MARQUE	REF OES	REFERENCE
MERCEDES	3494210010	1727601
MERCEDES	3494210310	1727601
MERCEDES	3494210610	1727601
MERCEDES	3494210910	1727601
MERCEDES	3494211010	1727601
MERCEDES	3494211210	1727601
MERCEDES	3504200219	MAC9496CAST
MERCEDES	3524210010	1768202
MERCEDES	3524210310	1768202
MERCEDES	3534230610	1768202
MERCEDES	3534231210	1768202
MERCEDES	3534232110	1773900
MERCEDES	3534233410	17297xx
MERCEDES	3554233410	19125xx
MERCEDES	3574211310	1970618
MERCEDES	3574211410	1970618
MERCEDES	3574212210	1779501
MERCEDES	3574230111	1970701
MERCEDES	3574230211	1970702
MERCEDES	3574230411	1970601
MERCEDES	3574230511	1970618
MERCEDES	3574230710	1970618
MERCEDES	3574231010	1970618
MERCEDES	3574231011	1970702
MERCEDES	3574231310	1970702
MERCEDES	3574231610	1970702
MERCEDES	3574231911	1970618
MERCEDES	3574232211	1970702
MERCEDES	3574233510	1970701
MERCEDES	3574233610	1970702
MERCEDES	3574234710	1970601
MERCEDES	3574234810	1970618
MERCEDES	3574235810	1970618
MERCEDES	3574236110	1970618
MERCEDES	3574237010	1970702
MERCEDES	3574237310	1970702
MERCEDES	3574238310	1970618
MERCEDES	3574238610	1970618
MERCEDES	3574239510	1970702
MERCEDES	3574239810	1970702
MERCEDES	3604210910	1723802
MERCEDES	3604211010	1723804
MERCEDES	3604211210	1723802
MERCEDES	3604211310	1723804
MERCEDES	3604211610	1723802
MERCEDES	3604230410	1949402
MERCEDES	3604230710	1949402
MERCEDES	3604231010	1723802
MERCEDES	3604231110	1723804

Les correspondances de références ont pour seul objectif d'aider la recherche de référence

Cross references are there for the sole purpose of helping the reference search

CORRESPONDANCE DES REFERENCES CROSS REFERENCE LIST

MARQUE	REF OES	REFERENCE
MERCEDES	3604231910	1949404
MERCEDES	3604232310	1723802
MERCEDES	3604232510	1773900
MERCEDES	3814210010	1768202
MERCEDES	3814210110	1768202
MERCEDES	3814232610	1723802
MERCEDES	3834210610	1768202
MERCEDES	3834210910	1768202
MERCEDES	3834211210	1773900
MERCEDES	3834211310	1773900
MERCEDES	3834212810	1723802
MERCEDES	3834212910	1723802
MERCEDES	3834213010	1723804
MERCEDES	3834231210	1773900
MERCEDES	3834231310	1773900
MERCEDES	3854210010	1949402
MERCEDES	3854210310	1949402
MERCEDES	3854211310	1723804
MERCEDES	3854230110	1723802
MERCEDES	3854230210	1723804
MERCEDES	3854230410	1723802
MERCEDES	3854230510	1723804
MERCEDES	3854230710	1723802
MERCEDES	3854230810	1723802
MERCEDES	3854231210	1723802
MERCEDES	3854231310	1949402
MERCEDES	3854231410	1949402
MERCEDES	3854231510	1949404
MERCEDES	3894206119	MAC9495CAST
MERCEDES	3894206419	MAC9495CAST
MERCEDES	3954200082	APF002
MERCEDES	3955860242	APF002
MERCEDES	4034200339	KRG001
MERCEDES	4164212510	1530000
MERCEDES	4614200020	1302001
MERCEDES	4634201220	1503002
MERCEDES	4634230110	1302001
MERCEDES	4634230210	1503002
MERCEDES	4634230310	1503003
MERCEDES	4884210010	1723802
MERCEDES	4884210110	1723804
MERCEDES	4974210010	1723802
MERCEDES	4974210110	1723804
MERCEDES	6014231710	1101901
MERCEDES	6014232110	1101901
MERCEDES	6014232610	1101901
MERCEDES	6014234410	1101901
MERCEDES	6014234810	1101901
MERCEDES	6014235001	TF0221

MARQUE	REF OES	REFERENCE
MERCEDES	6014235101	TF0220
MERCEDES	6014235310	1101901
MERCEDES	6014235410	1101901
MERCEDES	6014236010	1101901
MERCEDES	6014236110	1101901
MERCEDES	6014236810	1101901
MERCEDES	6014236910	1101901
MERCEDES	6014300922	1101901
MERCEDES	6014300922	MF0572
MERCEDES	6015400617	98016800
MERCEDES	6024231210	1302001
MERCEDES	6024231710	1302001
MERCEDES	6024231810	1302002
MERCEDES	6024232610	1302001
MERCEDES	6024232710	1302002
MERCEDES	6024233010	1302001
MERCEDES	6024233110	1302002
MERCEDES	6024233510	1302001
MERCEDES	6024233610	1302002
MERCEDES	6024233910	1302001
MERCEDES	6024234010	1302002
MERCEDES	6024234410	1302001
MERCEDES	6024234510	1302002
MERCEDES	6024234810	1302001
MERCEDES	6024234910	1302002
MERCEDES	6024236010	1302001
MERCEDES	6024236110	1302002
MERCEDES	6024236410	1302001
MERCEDES	6024236510	1302002
MERCEDES	6024301522	1302001
MERCEDES	6114209020	1503002
MERCEDES	6114209020	MF0525
MERCEDES	6114231010	1503002
MERCEDES	6114231110	1503003
MERCEDES	6114231410	1503002
MERCEDES	6114231510	1503003
MERCEDES	6114231810	1503002
MERCEDES	6114231910	1503003
MERCEDES	6114232210	1503002
MERCEDES	6114232310	1503003
MERCEDES	6114232510	1503002
MERCEDES	6114233010	1503003
MERCEDES	6174210010	1773900
MERCEDES	6174210410	1949402
MERCEDES	6174210910	1773900
MERCEDES	6174211210	1768202
MERCEDES	6174211610	1768202
MERCEDES	6174230030	1949602
MERCEDES	6174230110	1949505

Les correspondances de références ont pour seul objectif d'aider la recherche de référence

Cross references are there for the sole purpose of helping the reference search

CORRESPONDANCE DES REFERENCES CROSS REFERENCE LIST

MARQUE	REF OES	REFERENCE
MERCEDES	6174230310	1949502
MERCEDES	6174230311	1723802
MERCEDES	6174230411	1723804
MERCEDES	6174230530	1949602
MERCEDES	6174230711	1949402
MERCEDES	6174230910	1723802
MERCEDES	6174231111	1949502
MERCEDES	6174231330	1949502
MERCEDES	617423133067	1949502
MERCEDES	617423133068	1949502
MERCEDES	6174231430	1949504
MERCEDES	6174231511	1949502
MERCEDES	6174231710	1949502
MERCEDES	6174231711	1949504
MERCEDES	6174231730	1949402
MERCEDES	6174231810	1949504
MERCEDES	6174231830	1949404
MERCEDES	6174231910	1949505
MERCEDES	6174231911	1949402
MERCEDES	6174231930	1949404
MERCEDES	6174232011	1949404
MERCEDES	6174232130	1723802
MERCEDES	6174232210	1768202
MERCEDES	6174232230	1723804
MERCEDES	617423223067	1723802
MERCEDES	6174232311	1949502
MERCEDES	6174232411	1949504
MERCEDES	6174232530	1723802
MERCEDES	6174232610	1723802
MERCEDES	6174232630	1723802
MERCEDES	6174232710	1723804
MERCEDES	6174232711	1949502
MERCEDES	6174232911	1949505
MERCEDES	6174233010	1949402
MERCEDES	6174233110	1949404
MERCEDES	6174233111	1949602
MERCEDES	6174233211	1949604
MERCEDES	6174233311	1768202
MERCEDES	6174233410	1949502
MERCEDES	6174233411	1949602
MERCEDES	6174233911	1723802
MERCEDES	6174234011	1723804
MERCEDES	6174234310	1723802
MERCEDES	6174234311	1723802
MERCEDES	6174234410	1723804
MERCEDES	6174234411	1723804
MERCEDES	6174234710	1949402
MERCEDES	6174234711	1949402
MERCEDES	6174234811	1949404

MARQUE	REF OES	REFERENCE
MERCEDES	6174235110	1949502
MERCEDES	6174235111	1949502
MERCEDES	6174235310	1949505
MERCEDES	6174235510	1949602
MERCEDES	6174235511	1949602
MERCEDES	6174235610	1949604
MERCEDES	6174235710	1949605
MERCEDES	6174235711	1949605
MERCEDES	6174235911	1949502
MERCEDES	6174236210	1949602
MERCEDES	6174236310	1723802
MERCEDES	6174236311	1949502
MERCEDES	6174236410	1723804
MERCEDES	6174236511	1949505
MERCEDES	6174236710	1949402
MERCEDES	6174237110	1949502
MERCEDES	6174237111	1949502
MERCEDES	6174237310	1949505
MERCEDES	6174237510	1949602
MERCEDES	6174237610	1949604
MERCEDES	6174237710	1949605
MERCEDES	6174237910	1949602
MERCEDES	6174238010	1949604
MERCEDES	6174238110	1949605
MERCEDES	6174238111	1723802
MERCEDES	6174238211	1723802
MERCEDES	6174238310	1723802
MERCEDES	6174238410	1723804
MERCEDES	6174238710	1949402
MERCEDES	6174239110	1949502
MERCEDES	6174239210	1949504
MERCEDES	6174239310	1949505
MERCEDES	6174239311	1949502
MERCEDES	6174239510	1949602
MERCEDES	6174239610	1949604
MERCEDES	6174239710	1949605
MERCEDES	6174239911	1768202
MERCEDES	6179930610	RES009
MERCEDES	6179931110	RES009
MERCEDES	6204200119	MAC9496CAST
MERCEDES	6204200319	MAC9496CAST
MERCEDES	6204200519	MAC9496CAST
MERCEDES	6214210010	1949402
MERCEDES	6214210110	1949404
MERCEDES	6214210210	1949404
MERCEDES	6214210410	1949402
MERCEDES	6214210510	1949404
MERCEDES	6214210610	1949404
MERCEDES	6214210810	1949402

Les correspondances de références ont pour seul objectif d'aider la recherche de référence

Cross references are there for the sole purpose of helping the reference search

CORRESPONDANCE DES REFERENCES CROSS REFERENCE LIST

MARQUE	REF OES	REFERENCE
MERCEDES	621421081068	1949402
MERCEDES	6214210910	1949404
MERCEDES	6214211010	1949404
MERCEDES	6214230011	1949402
MERCEDES	6214230111	1949404
MERCEDES	6214230211	1949404
MERCEDES	6244200019	MAC9496CAST
MERCEDES	6244200219	MAC9496CAST
MERCEDES	6244200519	MAC9496CAST
MERCEDES	6254200023	ECF003
MERCEDES	6504231310	1723802
MERCEDES	6504231410	1723804
MERCEDES	6524200019	MAC9496CAST
MERCEDES	6524230410	1723802
MERCEDES	6524231210	1949502
MERCEDES	6524231410	1949505
MERCEDES	6524231610	1949602
MERCEDES	6524231710	1949604
MERCEDES	6524231810	1949605
MERCEDES	6594200419	MAC9496CAST
MERCEDES	6594200519	MAC9496CAST
MERCEDES	6594200619	MAC9495CAST
MERCEDES	6594202219	MAC9496CAST
MERCEDES	6594210010	1723802
MERCEDES	6594210110	1723804
MERCEDES	6594210410	1949402
MERCEDES	6594210810	1723802
MERCEDES	6594210910	1723804
MERCEDES	6594211210	1949402
MERCEDES	6594211610	1723802
MERCEDES	6594211710	1723804
MERCEDES	6594212010	1949402
MERCEDES	6594230010	1949502
MERCEDES	6594230108	MAC9496CAST
MERCEDES	6594230210	1949505
MERCEDES	6594230410	1949602
MERCEDES	6594230810	1949502
MERCEDES	6594230910	1949504
MERCEDES	6594231210	1949602
MERCEDES	6594231610	1949502
MERCEDES	6594231710	1949504
MERCEDES	6594232010	1949602
MERCEDES	6594232110	1949604
MERCEDES	6594232120	1949604
MERCEDES	6594232210	1949605
MERCEDES	6594232310	1949502
MERCEDES	6594232410	1949504
MERCEDES	6594232510	1949502
MERCEDES	6594232710	1949502

MARQUE	REF OES	REFERENCE
MERCEDES	6594232910	1949602
MERCEDES	6594233610	1949604
MERCEDES	6594233710	1949602
MERCEDES	6594233810	1949602
MERCEDES	6594233910	1949602
MERCEDES	6594234010	1949504
MERCEDES	6594234110	1949502
MERCEDES	6674230110	1503003
MERCEDES	6674230210	1503002
MERCEDES	6674231410	1503002
MERCEDES	6674231510	1503003
MERCEDES	6674232910	1503002
MERCEDES	6674233010	1503003
MERCEDES	6674233310	1503002
MERCEDES	6674233410	1503003
MERCEDES	6684230010	1735103
MERCEDES	6684230110	1735104
MERCEDES	6684230810	1735003
MERCEDES	6684230910	1735004
MERCEDES	6684231610	1505901
MERCEDES	6684232510	1735103
MERCEDES	6684232610	1735104
MERCEDES	6684232910	1735003
MERCEDES	6684233010	1735004
MERCEDES	6684233310	1505901
MERCEDES	6684233710	1735103
MERCEDES	6684233810	1735104
MERCEDES	6684234110	1735003
MERCEDES	6684234210	1735004
MERCEDES	6684234510	1505901
MERCEDES	6684236210	1505901
MERCEDES	6694230110	1735004
MERCEDES	6694230410	1735003
MERCEDES	6694230510	1735004
MERCEDES	6704231211	1735004
MERCEDES	6704231511	1735104
MERCEDES	6704232211	1735103
MERCEDES	6704232311	1735104
MERCEDES	6704232611	1735103
MERCEDES	6704232711	1735104
MERCEDES	6704233011	1735003
MERCEDES	6704233111	1735004
MERCEDES	6704233811	1505901
MERCEDES	6704234211	1505901
MERCEDES	6704234711	1735103
MERCEDES	6704234811	1735104
MERCEDES	6704235111	1735103
MERCEDES	6704235211	1735104
MERCEDES	6704235911	1735003

Les correspondances de références ont pour seul objectif d'aider la recherche de référence

Cross references are there for the sole purpose of helping the reference search

CORRESPONDANCE DES REFERENCES CROSS REFERENCE LIST

MARQUE	REF OES	REFERENCE
MERCEDES	6704236011	1735003
MERCEDES	6704236411	1735104
MERCEDES	6704236611	1735104
MERCEDES	6704237111	1735103
MERCEDES	6704237611	1735104
MERCEDES	6704238210	1735103
MERCEDES	6704238310	1735104
MERCEDES	6704239010	1735003
MERCEDES	6704239110	1735004
MERCEDES	6704239810	1505901
MERCEDES	6705400017	98016900
MERCEDES	6734200023	ECF010
MERCEDES	6734200123	ECF010
MERCEDES	6734200223	ECF010
MERCEDES	6734200323	ECF010
MERCEDES	6734210331	1728705
MERCEDES	6734210431	1728706
MERCEDES	6734210731	1728006
MERCEDES	6734210831	1728007
MERCEDES	6734211131	1727806
MERCEDES	6734211231	1727807
MERCEDES	6734211531	1516203
MERCEDES	6734211931	1516203
MERCEDES	6734212331	1727806
MERCEDES	6734212431	1727807
MERCEDES	6734212731	1728006
MERCEDES	6734212831	1728007
MERCEDES	6734213131	1728705
MERCEDES	6734213231	1728706
MERCEDES	6734213531	1728006
MERCEDES	6734213631	1728006
MERCEDES	6734213931	1950505
MERCEDES	6734214031	1950506
MERCEDES	6734214331	1950505
MERCEDES	6734214410	1516203
MERCEDES	6734214430	1728006
MERCEDES	6734214431	1950506
MERCEDES	6734215810	1728705
MERCEDES	6734215830	1516203
MERCEDES	6734215910	1728706
MERCEDES	6734216210	1728006
MERCEDES	6734216230	1728006
MERCEDES	6734216310	1728007
MERCEDES	6734216610	1727806
MERCEDES	6734216710	1727807
MERCEDES	6734217010	1516203
MERCEDES	6734217610	1728705
MERCEDES	6734217710	1728706
MERCEDES	6734218010	1728006

MARQUE	REF OES	REFERENCE
MERCEDES	6734218130	1728705
MERCEDES	6734218330	1728006
MERCEDES	6734218410	1727806
MERCEDES	6734218510	1727807
MERCEDES	6734218530	1728006
MERCEDES	6734218810	1516203
MERCEDES	6734218830	1727807
MERCEDES	6734219430	1728705
MERCEDES	6734219530	1728706
MERCEDES	6734219810	1727806
MERCEDES	6734219830	1727806
MERCEDES	6734219930	1727807
MERCEDES	6744210030	1729006
MERCEDES	6744210130	1729006
MERCEDES	6744210230	1729007
MERCEDES	6744210830	1729006
MERCEDES	6744210930	1729006
MERCEDES	6744211030	1729007
MERCEDES	6744211230	1728705
MERCEDES	6744211330	1728706
MERCEDES	6744211630	1728006
MERCEDES	6744211730	1728007
MERCEDES	6744212030	1727806
MERCEDES	6744212130	1727807
MERCEDES	6744212430	1516203
MERCEDES	6744212830	1728705
MERCEDES	6744212930	1728706
MERCEDES	6744213230	1728006
MERCEDES	6744213330	1728007
MERCEDES	6744213630	1727806
MERCEDES	6744213730	1727807
MERCEDES	6744214030	1516203
MERCEDES	6744214430	1728705
MERCEDES	6744214530	1728706
MERCEDES	6744214830	1728006
MERCEDES	6744214930	1728007
MERCEDES	6744215230	1727806
MERCEDES	6744215330	1727807
MERCEDES	6744215630	1516203
MERCEDES	6744219810	1727806
MERCEDES	6744219910	1727807
MERCEDES	6754210430	1729006
MERCEDES	6754210830	1950607
MERCEDES	6754210930	1950608
MERCEDES	6754211730	1729006
MERCEDES	6754211830	1729007
MERCEDES	6754212130	1950607
MERCEDES	6754212230	1950608
MERCEDES	6754212530	1950607

Les correspondances de références ont pour seul objectif d'aider la recherche de référence

Cross references are there for the sole purpose of helping the reference search

CORRESPONDANCE DES REFERENCES CROSS REFERENCE LIST

MARQUE	REF OES	REFERENCE
MERCEDES	6754212630	1950608
MERCEDES	6754212930	1950505
MERCEDES	6754213030	1950506
MERCEDES	6754213330	1950505
MERCEDES	6754213430	1950506
MERCEDES	6754213730	1729006
MERCEDES	6754213810	1729006
MERCEDES	6754213830	1729007
MERCEDES	6754214010	1729007
MERCEDES	6754214130	1950607
MERCEDES	6754214230	1950608
MERCEDES	6754214510	1950607
MERCEDES	6754214530	1950505
MERCEDES	6754214610	1950607
MERCEDES	6754214630	1950506
MERCEDES	6754214710	1950608
MERCEDES	6754214810	1950608
MERCEDES	6754216210	1729006
MERCEDES	6754216410	1729007
MERCEDES	6754216810	1950607
MERCEDES	6754216910	1950607
MERCEDES	6754217010	1950607
MERCEDES	6754217110	1950608
MERCEDES	6754217210	1950608
MERCEDES	6754218010	1950505
MERCEDES	6754218110	1950505
MERCEDES	6754218210	1950506
MERCEDES	6754218310	1950506
MERCEDES	6754218810	1950505
MERCEDES	6754218910	1950505
MERCEDES	6754219010	1950506
MERCEDES	6754219110	1950506
MERCEDES	6754219610	1950505
MERCEDES	6754219710	1950506
MERCEDES	6764210010	1729006
MERCEDES	6764210110	1729007
MERCEDES	6764210410	1950607
MERCEDES	6764210510	1950608
MERCEDES	6764210810	1950505
MERCEDES	6764210910	1950506
MERCEDES	6764211210	1729006
MERCEDES	6764211310	1729007
MERCEDES	6764211610	1950607
MERCEDES	6764211710	1950608
MERCEDES	6764212010	1950505
MERCEDES	6764212110	1950506
MERCEDES	6764212410	1729006
MERCEDES	6764212510	1729007
MERCEDES	6764212810	1950607

MARQUE	REF OES	REFERENCE
MERCEDES	6764212910	1950608
MERCEDES	6764213210	1950505
MERCEDES	6764213310	1950506
MERCEDES	6764214010	1729006
MERCEDES	6764214410	1729006
MERCEDES	6764214510	1729007
MERCEDES	6764215210	1729006
MERCEDES	6774200023	ECF010
MERCEDES	6774200123	ECF010
MERCEDES	6775400717	98017002
MERCEDES	6775400817	98017102
MERCEDES	9459930010	RES013
MERCEDES	A0004208738	ECF007
MERCEDES	A0004210131	1969905
MERCEDES	A00042111530	1949502
MERCEDES	A0004211630	1949504
MERCEDES	A0004230630	1949604
MERCEDES	A0035401217	98016800
MERCEDES	A0044201920	1302001
MERCEDES	A0054208118	CR0581
MERCEDES	A0084204218	CR0581
MERCEDES	A3014211510	1970601
MERCEDES	A3014218810	1779501
MERCEDES	A3014234910	1970618
MERCEDES	A3014235210	1970618
MERCEDES	A3014236110	1970702
MERCEDES	A3014236410	1970702
MERCEDES	A3014237010	1970601
MERCEDES	A3014237110	1970618
MERCEDES	A3014237910	1970701
MERCEDES	A3014238010	1970702
MERCEDES	A3024232710	19466xx
MERCEDES	A3024233010	19466xx
MERCEDES	A3054210010	1949402
MERCEDES	A3054230310	1949602
MERCEDES	A3054230610	19466xx
MERCEDES	A3054230910	1949602
MERCEDES	A3054231210	19466xx
MERCEDES	A3074200339	KRG001
MERCEDES	A3074204002	APF002
MERCEDES	A3094210410	1534906
MERCEDES	A3094210510	1534907
MERCEDES	A3094210710	1534906
MERCEDES	A3094210810	1534907
MERCEDES	A3094214910	1534906
MERCEDES	A3094215210	1558008
MERCEDES	A3094216710	1534906
MERCEDES	A3103251300	15057xx
MERCEDES	A3104213310	1558008

Les correspondances de références ont pour seul objectif d'aider la recherche de référence

Cross references are there for the sole purpose of helping the reference search

CORRESPONDANCE DES REFERENCES CROSS REFERENCE LIST

MARQUE	REF OES	REFERENCE
MERCEDES	A3104214410	1558008
MERCEDES	A3104215110	15057xx
MERCEDES	A3144210510	15057xx
MERCEDES	A3164211910	1740909
MERCEDES	A3164212310	1740909
MERCEDES	A3164212410	1740909
MERCEDES	A3164212510	1740909
MERCEDES	A3174215610	19125xx
MERCEDES	A3174232510	19466xx
MERCEDES	A3174232810	19466xx
MERCEDES	A3174233210	19466xx
MERCEDES	A3174233510	19466xx
MERCEDES	A3174235010	19466xx
MERCEDES	A3184211910	1740909
MERCEDES	A3244210610	15057xx
MERCEDES	A3244211010	15057xx
MERCEDES	A3244211410	15057xx
MERCEDES	A3254211110	1727601
MERCEDES	A3354200220	1727601
MERCEDES	A3354202920	1727601
MERCEDES	A3354210010	1727601
MERCEDES	A3354210110	1727601
MERCEDES	A3354210410	1727601
MERCEDES	A3354210510	1727601
MERCEDES	A3354211110	1727601
MERCEDES	A3354211510	1727601
MERCEDES	A3354211910	1727601
MERCEDES	A3354212710	1727601
MERCEDES	A3414234110	17298xx
MERCEDES	A3464210010	1723802
MERCEDES	A3464210110	1723804
MERCEDES	A3464230010	1949502
MERCEDES	A3464230310	1949402
MERCEDES	A3464230610	1949502
MERCEDES	A3464230910	1949502
MERCEDES	A3464231210	1949402
MERCEDES	A3464231910	1723802
MERCEDES	A3464232010	1723804
MERCEDES	A3464232210	1723802
MERCEDES	A3464232310	1723804
MERCEDES	A3464232510	1723802
MERCEDES	A3464232610	1723804
MERCEDES	A3464232810	1949502
MERCEDES	A3464233110	1949402
MERCEDES	A3464233410	1949502
MERCEDES	A3464233710	1949402
MERCEDES	A3464234010	1949402
MERCEDES	A3464234110	1723802
MERCEDES	A3464234210	1723804

MARQUE	REF OES	REFERENCE
MERCEDES	A3464234310	1723802
MERCEDES	A3464234610	1723802
MERCEDES	A3464234810	1949502
MERCEDES	A3464235510	1723802
MERCEDES	A3464235710	1949502
MERCEDES	A3464236710	1723802
MERCEDES	A3464239410	1723802
MERCEDES	A3464239510	1723802
MERCEDES	A3464239610	1949502
MERCEDES	A3464239710	1949502
MERCEDES	A3469930210	RES009
MERCEDES	A3469930310	RES008
MERCEDES	A3494210010	1727601
MERCEDES	A3494210310	1727601
MERCEDES	A3494210610	1727601
MERCEDES	A3494210910	1727601
MERCEDES	A3494211010	1727601
MERCEDES	A3494211210	1727601
MERCEDES	A3524210010	1768202
MERCEDES	A3524210310	1768202
MERCEDES	A3534230610	1768202
MERCEDES	A3534231210	1768202
MERCEDES	A3534232110	1773900
MERCEDES	A3534233410	17297xx
MERCEDES	A3554233410	19125xx
MERCEDES	A3574211310	1970618
MERCEDES	A3574211410	1970618
MERCEDES	A3574212210	1779501
MERCEDES	A3574230111	1970701
MERCEDES	A3574230211	1970702
MERCEDES	A3574230411	1970601
MERCEDES	A3574230511	1970618
MERCEDES	A3574230710	1970618
MERCEDES	A3574231010	1970618
MERCEDES	A3574231011	1970702
MERCEDES	A3574231310	1970702
MERCEDES	A3574231610	1970702
MERCEDES	A3574231911	1970618
MERCEDES	A3574232211	1970702
MERCEDES	A3574233510	1970701
MERCEDES	A3574233610	1970702
MERCEDES	A3574234710	1970601
MERCEDES	A3574234810	1970618
MERCEDES	A3574235810	1970618
MERCEDES	A3574236110	1970618
MERCEDES	A3574237010	1970702
MERCEDES	A3574237310	1970702
MERCEDES	A3574238310	1970618
MERCEDES	A3574238610	1970618

Les correspondances de références ont pour seul objectif d'aider la recherche de référence

Cross references are there for the sole purpose of helping the reference search

CORRESPONDANCE DES REFERENCES CROSS REFERENCE LIST

MARQUE	REF OES	REFERENCE
MERCEDES	A3574239510	1970702
MERCEDES	A3574239810	1970702
MERCEDES	A3604210910	1723802
MERCEDES	A3604211010	1723804
MERCEDES	A3604211210	1723802
MERCEDES	A3604211310	1723804
MERCEDES	A3604211610	1723802
MERCEDES	A3604230410	1949402
MERCEDES	A3604230710	1949402
MERCEDES	A3604231010	1723802
MERCEDES	A3604231110	1723804
MERCEDES	A3604232310	1723802
MERCEDES	A3604232510	1773900
MERCEDES	A3814210010	1768202
MERCEDES	A3814210110	1768202
MERCEDES	A3814232610	1723804
MERCEDES	A3834210610	1768202
MERCEDES	A3834210910	1768202
MERCEDES	A3834211210	1773900
MERCEDES	A3834211310	1773900
MERCEDES	A3834212810	1723802
MERCEDES	A3834212910	1723802
MERCEDES	A3834213010	1723804
MERCEDES	A3834231210	1773900
MERCEDES	A3834231310	1773900
MERCEDES	A3854210010	1949402
MERCEDES	A3854210310	1949402
MERCEDES	A3854211310	1723804
MERCEDES	A3854230110	1723802
MERCEDES	A3854230210	1723804
MERCEDES	A3854230410	1723802
MERCEDES	A3854230510	1723804
MERCEDES	A3854230710	1723802
MERCEDES	A3854230810	1723802
MERCEDES	A3854231210	1723802
MERCEDES	A3854231310	1949402
MERCEDES	A3854231410	1949402
MERCEDES	A3954200082	APF002
MERCEDES	A3955860242	APF002
MERCEDES	A4034200339	KRG001
MERCEDES	A4164212510	1530000
MERCEDES	A4614200020	1302001
MERCEDES	A4634201220	1503002
MERCEDES	A4634230110	1302001
MERCEDES	A4634230210	1503002
MERCEDES	A4634230310	1503003
MERCEDES	A4884210010	1723802
MERCEDES	A4884210110	1723804
MERCEDES	A4974210010	1723802

MARQUE	REF OES	REFERENCE
MERCEDES	A4974210110	1723804
MERCEDES	A6014231710	1101901
MERCEDES	A6014232110	1101901
MERCEDES	A6014232610	1101901
MERCEDES	A6014234410	1101901
MERCEDES	A6014234810	1101901
MERCEDES	A6014235310	1101901
MERCEDES	A6014235410	1101901
MERCEDES	A6014236010	1101901
MERCEDES	A6014236110	1101901
MERCEDES	A6014236810	1101901
MERCEDES	A6014236910	1101901
MERCEDES	A6014300922	1101901
MERCEDES	A6015400617	98016800
MERCEDES	A6024231210	1302001
MERCEDES	A6024231710	1302001
MERCEDES	A6024231810	1302002
MERCEDES	A6024232610	1302001
MERCEDES	A6024232710	1302002
MERCEDES	A6024233010	1302001
MERCEDES	A6024233110	1302002
MERCEDES	A6024233510	1302001
MERCEDES	A6024233610	1302002
MERCEDES	A6024233910	1302001
MERCEDES	A6024234010	1302002
MERCEDES	A6024234410	1302001
MERCEDES	A6024234510	1302002
MERCEDES	A6024234810	1302001
MERCEDES	A6024234910	1302002
MERCEDES	A6024236010	1302001
MERCEDES	A6024236110	1302002
MERCEDES	A6024236410	1302001
MERCEDES	A6024236510	1302002
MERCEDES	A6114209020	1503002
MERCEDES	A6114231010	1503002
MERCEDES	A6114231110	1503003
MERCEDES	A6114231410	1503002
MERCEDES	A6114231510	1503003
MERCEDES	A6114231810	1503002
MERCEDES	A6114231910	1503003
MERCEDES	A6114232210	1503002
MERCEDES	A6114232310	1503003
MERCEDES	A6114232510	1503002
MERCEDES	A6114233010	1503003
MERCEDES	A6174210010	1773900
MERCEDES	A6174210410	1949402
MERCEDES	A6174210910	1773900
MERCEDES	A6174211210	1768202
MERCEDES	A6174211610	1768202

Les correspondances de références ont pour seul objectif d'aider la recherche de référence

Cross references are there for the sole purpose of helping the reference search

CORRESPONDANCE DES REFERENCES CROSS REFERENCE LIST

MARQUE	REF OES	REFERENCE
MERCEDES	A6174230030	1949602
MERCEDES	A6174230310	1949502
MERCEDES	A6174230311	1723802
MERCEDES	A6174230411	1723804
MERCEDES	A6174230530	1949602
MERCEDES	A6174230711	1949402
MERCEDES	A6174230910	1723802
MERCEDES	A6174231111	1949502
MERCEDES	A6174231330	1949502
MERCEDES	A617423133067	1949502
MERCEDES	A617423133068	1949502
MERCEDES	A6174231511	1949502
MERCEDES	A6174231710	1949502
MERCEDES	A6174231730	1949402
MERCEDES	A6174231810	1949504
MERCEDES	A6174231911	1949402
MERCEDES	A6174231930	1949404
MERCEDES	A6174232130	1723802
MERCEDES	A6174232210	1768202
MERCEDES	A6174232230	1723804
MERCEDES	A617423223067	1723802
MERCEDES	A6174232311	1949502
MERCEDES	A6174232530	1723802
MERCEDES	A6174232610	1723802
MERCEDES	A6174232630	1723804
MERCEDES	A6174232710	1723804
MERCEDES	A6174232711	1949502
MERCEDES	A6174233010	1949402
MERCEDES	A6174233111	1949602
MERCEDES	A6174233311	1768202
MERCEDES	A6174233410	1949502
MERCEDES	A6174233411	1949602
MERCEDES	A6174233911	1723802
MERCEDES	A6174234011	1723804
MERCEDES	A6174234310	1723802
MERCEDES	A6174234311	1723802
MERCEDES	A6174234410	1723804
MERCEDES	A6174234411	1723804
MERCEDES	A6174234710	1949402
MERCEDES	A6174234711	1949402
MERCEDES	A6174235110	1949502
MERCEDES	A6174235111	1949502
MERCEDES	A6174235510	1949602
MERCEDES	A6174235511	1949602
MERCEDES	A6174235911	1949502
MERCEDES	A6174236210	1949602
MERCEDES	A6174236310	1723802
MERCEDES	A6174236311	1949502
MERCEDES	A6174236410	1723804

MARQUE	REF OES	REFERENCE
MERCEDES	A6174236710	1949402
MERCEDES	A6174237110	1949502
MERCEDES	A6174237111	1949502
MERCEDES	A6174237510	1949602
MERCEDES	A6174237910	1949602
MERCEDES	A6174238111	1723802
MERCEDES	A6174238211	1723802
MERCEDES	A6174238310	1723802
MERCEDES	A6174238410	1723804
MERCEDES	A6174238710	1949402
MERCEDES	A6174239110	1949502
MERCEDES	A6174239310	1949505
MERCEDES	A6174239311	1949502
MERCEDES	A6174239510	1949602
MERCEDES	A6174239610	1949604
MERCEDES	A6174239710	1949605
MERCEDES	A6174239911	1768202
MERCEDES	A6179930610	RES009
MERCEDES	A6179931110	RES009
MERCEDES	A6204200119	MAC9496CAST
MERCEDES	A6204200319	MAC9496CAST
MERCEDES	A6214210010	1949402
MERCEDES	A6214210011	1949402
MERCEDES	A6214210210	1949404
MERCEDES	A6214210410	1949402
MERCEDES	A6214210610	1949404
MERCEDES	A6214210810	1949402
MERCEDES	A621421081067	1949402
MERCEDES	A621421081068	1949402
MERCEDES	A6214211010	1949404
MERCEDES	A6214230011	1949402
MERCEDES	A6214230211	1949404
MERCEDES	A6244200019	MAC9496CAST
MERCEDES	A6244200219	MAC9496CAST
MERCEDES	A6244200519	MAC9496CAST
MERCEDES	A6254200023	ECF003
MERCEDES	A6314200020	1970601
MERCEDES	A6504231310	1723802
MERCEDES	A6504231410	1723804
MERCEDES	A6524200019	MAC9496CAST
MERCEDES	A6524230410	1723802
MERCEDES	A6524231210	1949502
MERCEDES	A6594200419	MAC9496CAST
MERCEDES	A6594200519	MAC9496CAST
MERCEDES	A6594202219	MAC9496CAST
MERCEDES	A6594210010	1723802
MERCEDES	A6594210110	1723804
MERCEDES	A6594210410	1949402
MERCEDES	A6594210810	1723802

Les correspondances de références ont pour seul objectif d'aider la recherche de référence

Cross references are there for the sole purpose of helping the reference search

CORRESPONDANCE DES REFERENCES CROSS REFERENCE LIST

MARQUE	REF OES	REFERENCE
MERCEDES	A6594210910	1723804
MERCEDES	A6594211210	1949402
MERCEDES	A6594211610	1723802
MERCEDES	A6594211710	1723804
MERCEDES	A6594212010	1949402
MERCEDES	A6594230010	1949502
MERCEDES	A6594230108	MAC9496CAST
MERCEDES	A6594230410	1949602
MERCEDES	A6594230810	1949502
MERCEDES	A6594231210	1949602
MERCEDES	A6594231610	1949502
MERCEDES	A6594232010	1949602
MERCEDES	A6594232120	1949604
MERCEDES	A6594232310	1949502
MERCEDES	A6594232510	1949502
MERCEDES	A6594232710	1949502
MERCEDES	A6594232910	1949602
MERCEDES	A6594233610	1949604
MERCEDES	A6594233710	1949602
MERCEDES	A6594233810	1949602
MERCEDES	A6594233910	1949602
MERCEDES	A6674230110	1503003
MERCEDES	A6674230210	1503002
MERCEDES	A6674231410	1503002
MERCEDES	A6674231510	1503003
MERCEDES	A6674232910	1503002
MERCEDES	A6674233010	1503003
MERCEDES	A6674233310	1503002
MERCEDES	A6674233410	1503003
MERCEDES	A6684230010	1735103
MERCEDES	A6684230110	1735104
MERCEDES	A6684230810	1735003
MERCEDES	A6684230910	1735004
MERCEDES	A6684231610	1505901
MERCEDES	A6684232510	1735103
MERCEDES	A6684232610	1735104
MERCEDES	A6684232910	1735003
MERCEDES	A6684233010	1735004
MERCEDES	A6684233310	1505901
MERCEDES	A6684233710	1735103
MERCEDES	A6684233810	1735104
MERCEDES	A6684234110	1735003
MERCEDES	A6684234210	1735004
MERCEDES	A6684234510	1505901
MERCEDES	A6684236210	1505901
MERCEDES	A6694230110	1735004
MERCEDES	A6694230410	1735003
MERCEDES	A6694230510	1735004
MERCEDES	A6704231211	1735004

MARQUE	REF OES	REFERENCE
MERCEDES	A6704231511	1735104
MERCEDES	A6704232211	1735103
MERCEDES	A6704232311	1735104
MERCEDES	A6704232611	1735103
MERCEDES	A6704232711	1735104
MERCEDES	A6704233011	1735003
MERCEDES	A6704233111	1735004
MERCEDES	A6704233811	1505901
MERCEDES	A6704234211	1505901
MERCEDES	A6704234711	1735103
MERCEDES	A6704234811	1735104
MERCEDES	A6704235111	1735103
MERCEDES	A6704235211	1735104
MERCEDES	A6704235911	1735003
MERCEDES	A6704236011	1735003
MERCEDES	A6704236411	1735104
MERCEDES	A6704236611	1735104
MERCEDES	A6704237111	1735103
MERCEDES	A6704237611	1735104
MERCEDES	A6704238210	1735103
MERCEDES	A6704238310	1735104
MERCEDES	A6704239010	1735003
MERCEDES	A6704239110	1735004
MERCEDES	A6704239810	1505901
MERCEDES	A6705400017	98016900
MERCEDES	A6734200023	ECF010
MERCEDES	A6734200123	ECF010
MERCEDES	A6734200223	ECF010
MERCEDES	A6734200323	ECF010
MERCEDES	A6734210331	1728705
MERCEDES	A6734210431	1728706
MERCEDES	A6734210731	1728006
MERCEDES	A6734210831	1728007
MERCEDES	A6734211131	1727806
MERCEDES	A6734211231	1727807
MERCEDES	A6734211531	1516203
MERCEDES	A6734211931	1516203
MERCEDES	A6734212331	1727806
MERCEDES	A6734212431	1727807
MERCEDES	A6734212731	1728006
MERCEDES	A6734212831	1728007
MERCEDES	A6734213131	1728705
MERCEDES	A6734213231	1728706
MERCEDES	A6734213531	1728006
MERCEDES	A6734213931	1950505
MERCEDES	A6734214031	1950506
MERCEDES	A6734214331	1950505
MERCEDES	A6734214410	1516203
MERCEDES	A6734214430	1728006

Les correspondances de références ont pour seul objectif d'aider la recherche de référence

Cross references are there for the sole purpose of helping the reference search

CORRESPONDANCE DES REFERENCES CROSS REFERENCE LIST

MARQUE	REF OES	REFERENCE
MERCEDES	A6734214431	1950506
MERCEDES	A6734215810	1728705
MERCEDES	A6734215830	1516203
MERCEDES	A6734215910	1728706
MERCEDES	A6734216210	1728006
MERCEDES	A6734216230	1728006
MERCEDES	A6734216310	1728007
MERCEDES	A6734216330	1728007
MERCEDES	A6734216610	1727806
MERCEDES	A6734216710	1727807
MERCEDES	A6734217010	1516203
MERCEDES	A6734217610	1728705
MERCEDES	A6734217710	1728706
MERCEDES	A6734218010	1728006
MERCEDES	A6734218110	1728007
MERCEDES	A6734218130	1728705
MERCEDES	A6734218330	1728006
MERCEDES	A6734218410	1727806
MERCEDES	A6734218510	1727807
MERCEDES	A6734218530	1728006
MERCEDES	A6734218810	1516203
MERCEDES	A6734218830	1727807
MERCEDES	A6734219430	1728705
MERCEDES	A6734219530	1728706
MERCEDES	A6734219810	1727806
MERCEDES	A6734219830	1727806
MERCEDES	A6734219930	1727807
MERCEDES	A6744210030	1729006
MERCEDES	A6744210130	1729006
MERCEDES	A6744210230	1729007
MERCEDES	A6744210830	1729006
MERCEDES	A6744210930	1729006
MERCEDES	A6744211030	1729007
MERCEDES	A6744211230	1728705
MERCEDES	A6744211330	1728706
MERCEDES	A6744211630	1728006
MERCEDES	A6744211730	1728007
MERCEDES	A6744212030	1727806
MERCEDES	A6744212130	1727807
MERCEDES	A6744212430	1516203
MERCEDES	A6744212830	1728705
MERCEDES	A6744212930	1728706
MERCEDES	A6744213230	1728006
MERCEDES	A6744213330	1728007
MERCEDES	A6744213630	1727806
MERCEDES	A6744213730	1727807
MERCEDES	A6744214030	1516203
MERCEDES	A6744214430	1728705
MERCEDES	A6744214530	1728706

MARQUE	REF OES	REFERENCE
MERCEDES	A6744214830	1728006
MERCEDES	A6744214930	1728007
MERCEDES	A6744215230	1727806
MERCEDES	A6744215330	1727807
MERCEDES	A6744215630	1516203
MERCEDES	A6744219810	1727806
MERCEDES	A6744219910	1727807
MERCEDES	A6754210430	1729006
MERCEDES	A6754210830	1950607
MERCEDES	A6754210930	1950608
MERCEDES	A6754211730	1729006
MERCEDES	A6754211830	1729007
MERCEDES	A6754212130	1950607
MERCEDES	A6754212230	1950608
MERCEDES	A6754212530	1950607
MERCEDES	A6754212630	1950608
MERCEDES	A6754212930	1950505
MERCEDES	A6754213030	1950506
MERCEDES	A6754213330	1950505
MERCEDES	A6754213430	1950506
MERCEDES	A6754213730	1729006
MERCEDES	A6754213810	1729006
MERCEDES	A6754213830	1729007
MERCEDES	A6754214010	1729007
MERCEDES	A6754214130	1950607
MERCEDES	A6754214230	1950608
MERCEDES	A6754214510	1950607
MERCEDES	A6754214530	1950505
MERCEDES	A6754214610	1950607
MERCEDES	A6754214630	1950506
MERCEDES	A6754214710	1950608
MERCEDES	A6754214810	1950608
MERCEDES	A6754216210	1729006
MERCEDES	A6754216410	1729007
MERCEDES	A6754216810	1950607
MERCEDES	A6754216910	1950607
MERCEDES	A6754217010	1950607
MERCEDES	A6754217110	1950608
MERCEDES	A6754217210	1950608
MERCEDES	A6754218010	1950505
MERCEDES	A6754218110	1950505
MERCEDES	A6754218210	1950506
MERCEDES	A6754218310	1950506
MERCEDES	A6754218810	1950505
MERCEDES	A6754218910	1950505
MERCEDES	A6754219010	1950506
MERCEDES	A6754219110	1950506
MERCEDES	A6754219610	1950505
MERCEDES	A6754219710	1950506

Les correspondances de références ont pour seul objectif d'aider la recherche de référence

Cross references are there for the sole purpose of helping the reference search

CORRESPONDANCE DES REFERENCES CROSS REFERENCE LIST

MARQUE	REF OES	REFERENCE
MERCEDES	A6764210010	1729006
MERCEDES	A6764210110	1729007
MERCEDES	A6764210410	1950607
MERCEDES	A6764210510	1950608
MERCEDES	A6764210810	1950505
MERCEDES	A6764210910	1950506
MERCEDES	A6764211210	1729006
MERCEDES	A6764211310	1729007
MERCEDES	A6764211610	1950607
MERCEDES	A6764211710	1950608
MERCEDES	A6764212010	1950505
MERCEDES	A6764212110	1950506
MERCEDES	A6764212410	1729006
MERCEDES	A6764212510	1729007
MERCEDES	A6764212810	1950607
MERCEDES	A6764212910	1950608
MERCEDES	A6764213210	1950505
MERCEDES	A6764213310	1950506
MERCEDES	A6764214010	1729006
MERCEDES	A6764214410	1729006
MERCEDES	A6764214510	1729007
MERCEDES	A6764215210	1729006
MERCEDES	A6774200023	ECF010
MERCEDES	A6774200123	ECF010
MERCEDES	A6775400717	98017002
MERCEDES	A6775400817	98017102
MERCEDES	A9459930010	RES013
MERCEDES	D65481213	ECF001
MERITOR	1205E2683	AC0028
MERITOR	1205X2000	AC0029
MERITOR	2297H8354	AC0025
MERITOR	2297J8356	AC0026
MERITOR	2297R5920	AC0017
MERITOR	3280T8964	AC0024
MERITOR	3280V8368	AC0034
MERITOR	3280W8369	AC0027
MERITOR	64225252	AC0007
MERITOR	68021051	ECF010
MERITOR	68191065	AC0009
MERITOR	68191403	CAM007
MERITOR	68191404	CAM008
MERITOR	68191510	AC0010
MERITOR	68191511	AC0011
MERITOR	68191614	CAM001
MERITOR	68191615	CAM002
MERITOR	68191649	ECF009
MERITOR	68192115	AC0013
MERITOR	68192410	AC0014
MERITOR	68192612	AC0015

MARQUE	REF OES	REFERENCE
MERITOR	68192681	SUP001
MERITOR	68192682	SUP002
MERITOR	68192686	CAM009
MERITOR	68192687	CAM010
MERITOR	68200150	AC0016
MERITOR	68370794	MAC7017
MERITOR	68371277NQT	1970803
MERITOR	68371366NQT	1701703
MERITOR	68371371NQT	1917705
MERITOR	68371534NQU	1907102
MERITOR	68371536NQU	1906802
MERITOR	68937381	MAC9071/2
MERITOR	68937383	MAC9068/2
MERITOR	68937385	MAC7992/2
MERITOR	68937386	MAC9941/2
MERITOR	68937388	MAC9090/2
MERITOR	A2237K1051	KTU012
MERITOR	A2237L1052	98032200
MERITOR	A2237L1312	KTU011
MERITOR	A2237R1162	KTU013
MERITOR	A2247L1000	AC0032
MERITOR	A2247M1001	AC0038
MERITOR	A2297N6358	AC0031
MERITOR	A2297S8287	AC0023
MERITOR	A2297U4597	AC0035
MERITOR	A3280K8435	AC0030
MERITOR	MBSK1000-4	1903770
MERITOR	MBSK1010-4	1936970
MERITOR	MBSK1040-4	1903070
MERITOR	MBSK2000-4	1903271
MERITOR	MBSK2010-4	1909470
MERITOR	MBSK2490-4	1961370
MERITOR	MBSK2500-4	1955770
MERITOR	RBSK0248B.M	ACK015
MERITOR	RBSK0249B.M	ACK016
MERITOR	RBSK0250B.M	ACK011
MERITOR	RBSK0251B.M	ACK014
MERITOR	RBSK0343.M	ACK002
MERITOR	RBSK0502B.M	ACK009
MERITOR	RBSK0549B.M	ACK019
MERITOR	RBSK1212	1938414
MERITOR	RBSK1213	1938415
MERITOR	RBSK1226	1938414
MERITOR	RBSK1227	1938415
MERITOR	RBSK1255.M	ACK012
MERITOR	RBSK1409.M	ACK003
MERITOR	RBSK1481.M	AC0036
MERITOR	RBSK1482.M	AC0037
MERITOR	RBSK1523.M	1971478

Les correspondances de références ont pour seul objectif d'aider la recherche de référence

Cross references are there for the sole purpose of helping the reference search

CORRESPONDANCE DES REFERENCES CROSS REFERENCE LIST

MARQUE	REF OES	REFERENCE
MERITOR	RBSK1526.M	1971678
MERITOR	RBSK1558.M	ACK004
MERITOR	RBSK1560.M	ACK010
MERITOR	RBSK1561.M	ACK020
MERITOR	RBSK1563.M	ACK021
MERITOR	RBSK1573.M	ACK013
MERITOR	RBSK1586.M	KRES009
MERITOR	RBSK1613.M	1911678
MERITOR	RBSK1632.M	1910978
MERITOR	RBSK2051.M	ACK008
MERITOR	RBSK2128.M	KRES010
MERITOR	RBSK2288.M	ACK007
MERITOR	RBSK2289.M	ACK005
MERITOR	RBSK2301.M	ACK006
MERITOR	RD15705219	FCD003
MERITOR	RD15705220	FCD004
MERITOR	RD41018235	FCD005
MERITOR	RD41018236	FCD006
MERITOR	RD41020243	FCD009
MERITOR	RD41020244	FCD010
MERITOR	RD41020335	FCD011
MERITOR	RD41020336	FCD012
MERITOR	RS15705223	FCS001
MERITOR	RS15705224	FCS002
MERITOR	RS15705232	FCS100
MERITOR	RS36017239	FCS003
MERITOR	RS36017240	FCS004
MERITOR	RS41018205	FCS005
MERITOR	RS41018206	FCS006
MERITOR	RS41020307	FCS009
MERITOR	RS41020308	FCS010
MERITOR	SP8540	AC0001
MERITOR	ST1035	AC0002
MERITOR	ST1036	AC0003
MERITOR	ST1037	AC0004
MERITOR	ST4013	AC0006
MERITOR	ST4014	AC0005
NATO	5360123103959	RES011
NATO	5360123458587	RES012
NEOPLAN	080131910	ECF001
NEOPLAN	11014929	ECF001
NISSAN	069029000	MF0353
NISSAN	069053200	MF0353
NISSAN	44000F3803	MF0353
NISSAN	441009X125	CR0618
NISSAN	44100D6200	CR1004
NISSAN	6464706	CR0618
NISSAN	69012170	CR1004
NISSAN	69021740	CR1021

MARQUE	REF OES	REFERENCE
NISSAN	69022780	CR1021
NISSAN	69030110	CR1021
NISSAN	69030120	CR1022
NISSAN	69041420	CR1022
NISSAN	YC152261AA	CR0618
PERROT	12739075VT	ECF001
PERROT	12739076VT	ECF002
PERROT	12739085VT	ECF003
PERROT	12739086VT	ECF004
PERROT	13 057 510	17374001549
PERROT	13057250	19687001549
PERROT	13057252	19690001549
PERROT	13057510	17237001549
PERROT	13057846	19041001549
PERROT	13057847	19042001549
PERROT	13057858	17374001549
PERROT	14352031	ECF002
RABA	318393341014	1923601
RABA	318933341013	1923502
RENAULT	7701201617	MF0353
RENAULT TRUCKS	5000001165	CRB143
RENAULT TRUCKS	5000001166	CRB144
RENAULT TRUCKS	5000001169	CRB147
RENAULT TRUCKS	5000242586	CR0549
RENAULT TRUCKS	5000242587	CR0550
RENAULT TRUCKS	5000243040	CR0539
RENAULT TRUCKS	5000243144	CR0546
RENAULT TRUCKS	5000288508	1993502
RENAULT TRUCKS	5000288509	1993510
RENAULT TRUCKS	5000288510	1946301
RENAULT TRUCKS	5000288512	1993402
RENAULT TRUCKS	5000288514	1904902
RENAULT TRUCKS	5000288515	1904911
RENAULT TRUCKS	5000288518	17829xx
RENAULT TRUCKS	5000288519	17829xx
RENAULT TRUCKS	5000288520	1783102
RENAULT TRUCKS	5000288522	1783102
RENAULT TRUCKS	5000288523	17831xx
RENAULT TRUCKS	5000288524	1925501
RENAULT TRUCKS	5000288525	1925502
RENAULT TRUCKS	5000295945	1962005
RENAULT TRUCKS	5000393657	CR0827
RENAULT TRUCKS	5000516025	CR0690
RENAULT TRUCKS	5000559091	1782704
RENAULT TRUCKS	5000559107	CR0928
RENAULT TRUCKS	5000559108	CR0929
RENAULT TRUCKS	5000559150	CR0932
RENAULT TRUCKS	5000559151	CR0933
RENAULT TRUCKS	5000559160	1962004

Les correspondances de références ont pour seul objectif d'aider la recherche de référence

Cross references are there for the sole purpose of helping the reference search

CORRESPONDANCE DES REFERENCES CROSS REFERENCE LIST

MARQUE	REF OES	REFERENCE
RENAULT TRUCKS	5000559194	CR0936
RENAULT TRUCKS	5000559197	CR0937
RENAULT TRUCKS	5000559440	17309xx
RENAULT TRUCKS	5000559441	1904902
RENAULT TRUCKS	5000560943	1782705
RENAULT TRUCKS	5000560980	CR0940
RENAULT TRUCKS	5000560981	CR0941
RENAULT TRUCKS	5000560984	1783102
RENAULT TRUCKS	5000671980	BE0001
RENAULT TRUCKS	5000716600	AC0019
RENAULT TRUCKS	5000716656	AC0018
RENAULT TRUCKS	5000792794	MAC9934
RENAULT TRUCKS	5000792795	MAC9935
RENAULT TRUCKS	5000793121	1946301
RENAULT TRUCKS	5000809635	17309xx
RENAULT TRUCKS	5000809636	1904911
RENAULT TRUCKS	5000811113	1993502
RENAULT TRUCKS	5000811574	1993502
RENAULT TRUCKS	5000811877	1904902
RENAULT TRUCKS	5000811878	1946301
RENAULT TRUCKS	5000811881	1904911
RENAULT TRUCKS	5000812335	1993402
RENAULT TRUCKS	5000814699	CR0891
RENAULT TRUCKS	5000814836	1903230
RENAULT TRUCKS	5000814837	1909437
RENAULT TRUCKS	5000814854	1904902
RENAULT TRUCKS	5000814855	1904902
RENAULT TRUCKS	5000814856	1904911
RENAULT TRUCKS	5000814857	1904911
RENAULT TRUCKS	5000814858	1946301
RENAULT TRUCKS	5000814860	1904902
RENAULT TRUCKS	5000814861	1904911
RENAULT TRUCKS	5000815053	17829xx
RENAULT TRUCKS	5000815054	17829xx
RENAULT TRUCKS	5000815055	1783102
RENAULT TRUCKS	5000815056	17831xx
RENAULT TRUCKS	5000815370	CR0918
RENAULT TRUCKS	5000815484	AB337276
RENAULT TRUCKS	5000815489	KRES006
RENAULT TRUCKS	5000815514	CR0896
RENAULT TRUCKS	5000815603	CR0925
RENAULT TRUCKS	5000815604	CR0926
RENAULT TRUCKS	5000815640	1925501
RENAULT TRUCKS	5000816057	1904911
RENAULT TRUCKS	5000816058	1904902
RENAULT TRUCKS	5000816602	CR0934
RENAULT TRUCKS	5000816603	CR0935
RENAULT TRUCKS	5000816604	CR0930
RENAULT TRUCKS	5000816605	CR0931

MARQUE	REF OES	REFERENCE
RENAULT TRUCKS	5000819160	1782704
RENAULT TRUCKS	5000819161	1962004
RENAULT TRUCKS	5000819162	1782705
RENAULT TRUCKS	5000819163	1962005
RENAULT TRUCKS	5000820063	1993502
RENAULT TRUCKS	5000820588	AB337220
RENAULT TRUCKS	5000821135	1904902
RENAULT TRUCKS	5000821136	1946301
RENAULT TRUCKS	5000821730	1904902
RENAULT TRUCKS	5000821731	1904911
RENAULT TRUCKS	5000821732	1946301
RENAULT TRUCKS	5000821815	1993402
RENAULT TRUCKS	5000821817	1993502
RENAULT TRUCKS	5000821818	1993510
RENAULT TRUCKS	5000822061	1993402
RENAULT TRUCKS	5000822063	1993502
RENAULT TRUCKS	5000822064	1993510
RENAULT TRUCKS	5000822065	17309xx
RENAULT TRUCKS	5000822066	17309xx
RENAULT TRUCKS	5000822595	1783102
RENAULT TRUCKS	5000822597	1782704
RENAULT TRUCKS	5000822598	1782705
RENAULT TRUCKS	5000822599	1962004
RENAULT TRUCKS	5000822604	1925502
RENAULT TRUCKS	5000822605	1962005
RENAULT TRUCKS	5000823230	MAC7017
RENAULT TRUCKS	5000823231	ECF009
RENAULT TRUCKS	5000823243	1701703
RENAULT TRUCKS	5000823538	1993402
RENAULT TRUCKS	5000823921	1903230
RENAULT TRUCKS	5000823922	1909437
RENAULT TRUCKS	5000824295	1904902
RENAULT TRUCKS	5000824296	1904911
RENAULT TRUCKS	5000824297	1946301
RENAULT TRUCKS	5000825257	1993402
RENAULT TRUCKS	5000825618	1946301
RENAULT TRUCKS	5000916058	1904902
RENAULT TRUCKS	5000987156	CR0837
RENAULT TRUCKS	5000987157	CR0838
RENAULT TRUCKS	5000987158	CR0835
RENAULT TRUCKS	5000987159	CR0836
RENAULT TRUCKS	5001019221	1993502
RENAULT TRUCKS	5001019222	1918702
RENAULT TRUCKS	5001823154	AB350929
RENAULT TRUCKS	5001823158	AB350891
RENAULT TRUCKS	5001823215	1783102
RENAULT TRUCKS	5001823217	19709xx
RENAULT TRUCKS	5001823240	1918702
RENAULT TRUCKS	5001823241	1918704

Les correspondances de références ont pour seul objectif d'aider la recherche de référence

Cross references are there for the sole purpose of helping the reference search

CORRESPONDANCE DES REFERENCES CROSS REFERENCE LIST

MARQUE	REF OES	REFERENCE
RENAULT TRUCKS	5001823263	KRES005
RENAULT TRUCKS	5001825100	1993502
RENAULT TRUCKS	5001825533	17309xx
RENAULT TRUCKS	5001825534	17309xx
RENAULT TRUCKS	5001825620	1904902
RENAULT TRUCKS	5001825621	1904911
RENAULT TRUCKS	5001825627	1925501
RENAULT TRUCKS	5001825629	1925502
RENAULT TRUCKS	5001829350	MF0601
RENAULT TRUCKS	5001829558	1993510
RENAULT TRUCKS	5001832024	19502xx
RENAULT TRUCKS	5001838212	1993480
RENAULT TRUCKS	5001838285	1918780
RENAULT TRUCKS	5001839079	FCS100
RENAULT TRUCKS	5001855104	1993402
RENAULT TRUCKS	5001855105	1993410
RENAULT TRUCKS	5001855106	1993502
RENAULT TRUCKS	5001855107	1993510
RENAULT TRUCKS	5001855122	1918702
RENAULT TRUCKS	5001855123	1918704
RENAULT TRUCKS	5001855146	1918702
RENAULT TRUCKS	5001855147	1918704
RENAULT TRUCKS	5001858102	1701703
RENAULT TRUCKS	5001859264	1782704
RENAULT TRUCKS	5001859266	1783102
RENAULT TRUCKS	5001859270	1782704
RENAULT TRUCKS	5001859271	1782705
RENAULT TRUCKS	5001859272	1962004
RENAULT TRUCKS	5001859273	1962005
RENAULT TRUCKS	5001859274	1946301
RENAULT TRUCKS	5001859276	1904902
RENAULT TRUCKS	5001859278	1925501
RENAULT TRUCKS	5001859280	17805xx
RENAULT TRUCKS	5001860030	1993402
RENAULT TRUCKS	5001860031	1993410
RENAULT TRUCKS	5001860032	1993502
RENAULT TRUCKS	5001860033	1993510
RENAULT TRUCKS	5001860048	1918702
RENAULT TRUCKS	5001860049	1918704
RENAULT TRUCKS	5001865097	CR0930
RENAULT TRUCKS	5001865098	CR0931
RENAULT TRUCKS	5001865103	CR0549
RENAULT TRUCKS	5001865104	CR0550
RENAULT TRUCKS	5001865106	CR0896
RENAULT TRUCKS	5001865109	CR0918
RENAULT TRUCKS	5001865111	CR0827
RENAULT TRUCKS	5001865113	CR0539
RENAULT TRUCKS	5001865114	CR0546
RENAULT TRUCKS	5001865118	CR0891

MARQUE	REF OES	REFERENCE
RENAULT TRUCKS	5001865119	CR0690
RENAULT TRUCKS	5001865120	CRB190
RENAULT TRUCKS	5001865123	CR0367
RENAULT TRUCKS	5001865124	CRB157
RENAULT TRUCKS	5001865658	1925580
RENAULT TRUCKS	5001866959	CR0925
RENAULT TRUCKS	5001866960	CR0926
RENAULT TRUCKS	5001866961	CR0934
RENAULT TRUCKS	5001866962	CR0935
RENAULT TRUCKS	5001867100	MF0601
RENAULT TRUCKS	5001868087	1909002
RENAULT TRUCKS	5001868088	1909005
RENAULT TRUCKS	5001868089	1907102
RENAULT TRUCKS	5001868090	1907105
RENAULT TRUCKS	5001868091	1906802
RENAULT TRUCKS	5001868092	1906805
RENAULT TRUCKS	5001868113	AC0013
RENAULT TRUCKS	5001868114	AC0016
RENAULT TRUCKS	5001868117	AC0006
RENAULT TRUCKS	5001868118	AC0005
RENAULT TRUCKS	5001868119	AC0014
RENAULT TRUCKS	5001868120	AC0007
RENAULT TRUCKS	5001868121	AC0001
RENAULT TRUCKS	5001868122	AC0012
RENAULT TRUCKS	5001868125	AC0010
RENAULT TRUCKS	5001868126	AC0011
RENAULT TRUCKS	5001868127	AC0009
RENAULT TRUCKS	5001868128	AC0015
RENAULT TRUCKS	5001868158	CAM005
RENAULT TRUCKS	5001868159	CAM006
RENAULT TRUCKS	5001868167	CAM008
RENAULT TRUCKS	5001868168	CAM007
RENAULT TRUCKS	5001868204	CAM002
RENAULT TRUCKS	5001868205	CAM001
RENAULT TRUCKS	5001868569	MAC9090/2
RENAULT TRUCKS	5001868572	MAC9071/2
RENAULT TRUCKS	5001868573	MAC9068/2
RENAULT TRUCKS	5001873631	SUP001
RENAULT TRUCKS	5001873632	SUP002
RENAULT TRUCKS	5006018433	CAM001
RENAULT TRUCKS	5006018434	CAM002
RENAULT TRUCKS	5010046458	CR0835
RENAULT TRUCKS	5010046459	CR0836
RENAULT TRUCKS	5010046460	CR0837
RENAULT TRUCKS	5010046461	CR0838
RENAULT TRUCKS	5010067400	AC0020
RENAULT TRUCKS	5010067400	APF001
RENAULT TRUCKS	5010067564	APF001/2
RENAULT TRUCKS	5010067942	CAM003

Les correspondances de références ont pour seul objectif d'aider la recherche de référence

Cross references are there for the sole purpose of helping the reference search

CORRESPONDANCE DES REFERENCES CROSS REFERENCE LIST

MARQUE	REF OES	REFERENCE
RENAULT TRUCKS	5010067943	CAM004
RENAULT TRUCKS	5010097089	RES002
RENAULT TRUCKS	5010097260	MAC9935K
RENAULT TRUCKS	5010097262	AXE002
RENAULT TRUCKS	5010097340	RES001
RENAULT TRUCKS	5010098945	RES004
RENAULT TRUCKS	5010098946	AXE001
RENAULT TRUCKS	5010098948	MAC9187
RENAULT TRUCKS	5010216613	APF001/3
RENAULT TRUCKS	5010224053	MAC9934K
RENAULT TRUCKS	5010224629	MAC9974
RENAULT TRUCKS	5010422362	AC0021
RENAULT TRUCKS	5010525775	MAC9187K
RENAULT TRUCKS	5010566199	BE0001
RENAULT TRUCKS	7400276097	AC0003
RENAULT TRUCKS	7400276098	AC0004
RENAULT TRUCKS	7403090964	AC0002
RENAULT TRUCKS	7420851343	CR0836
RENAULT TRUCKS	7420851344	CR0837
RENAULT TRUCKS	7421534374	1909002
RENAULT TRUCKS	7421534386	1907102
RENAULT TRUCKS	7421534392	1906802
RENAULT TRUCKS	7421534397	1909005
RENAULT TRUCKS	7421534401	1906802
RENAULT TRUCKS	7485013109	1906880
RENAULT TRUCKS	7485013110	1907180
RENAULT TRUCKS	7701001747	CR0310
RENAULT TRUCKS	7701010167	1904902
RENAULT TRUCKS	7701010168	1904911
RENAULT TRUCKS	7701010593	1904902
RENAULT TRUCKS	7701010594	1904911
RENAULT TRUCKS	7701365115	CRB157
RENAULT TRUCKS	7703002134	AC0008
RENAULT TRUCKS	7703067135	APF001/1
RENAULT TRUCKS	770507400	CR0367
RENAULT TRUCKS	770507500	CR0366
RENAULT TRUCKS	870090900	CR0366
RENAULT TRUCKS	870441200	CR0342
RENAULT TRUCKS	870441300	CR0351
RENAULT TRUCKS	870507400	CR0367
RENAULT TRUCKS	870618400	CRB190
ROR	15205192E	1936908
ROR	15205192E	1936912
ROR	15205192R	1936970
ROR	15205536E	1903712
ROR	15205536R	1903770
ROR	15206004E	1960408
ROR	15206004R	1960470
ROR	15209714E	1990803

MARQUE	REF OES	REFERENCE
ROR	15224952R	1903070
ROR	21010776	1960408
ROR	21200780B	1960408
ROR	21200781B	1960408
ROR	21200790B	1903712
ROR	21200791B	1903712
ROR	21200794B	1936912
ROR	21200795B	1936912
ROR	21209710B	1990803
ROR	21209710E	1990803
ROR	21209711B	1990803
ROR	21209711E	1990803
ROR	21224717R	1903001
ROR	21224718R	1903001
ROR	60207753R	1936908
ROR	60207755R	1960408
ROR	60207757R	1903001
SAF	1057001000	1737707
SAF	1057001200	1903230
SAF	1057001210	1903231
SAF	1057001220	1903232
SAF	1057002200	15751xx
SAF	1057002400	1951512
SAF	1057002410	1951513
SAF	1057002420	1951511
SAF	1057002500	1951512
SAF	1057002510	1951513
SAF	1057002520	1951511
SAF	1057003300	1951701
SAF	1057003310	19517xx
SAF	1057003400	1951701
SAF	1057003410	19517xx
SAF	1057004300	1989208
SAF	1057004400	1989208
SAF	1057004410	1989202
SAF	1057004800	1991201
SAF	1057004900	1991201
SAF	1057004910	1991202
SAF	1057006000	1928308
SAF	1057006010	1928309
SAF	1057006100	1928308
SAF	1057006110	1928306
SAF	1057006300	19422xx
SAF	1057006600	1947706
SAF	1057006610	1947707
SAF	1057006700	1947706
SAF	1057006710	1947707
SAF	1057006800	1947905
SAF	1057006810	19479xx

Les correspondances de références ont pour seul objectif d'aider la recherche de référence

Cross references are there for the sole purpose of helping the reference search

CORRESPONDANCE DES REFERENCES CROSS REFERENCE LIST

MARQUE	REF OES	REFERENCE
SAF	1057006900	1947905
SAF	1057006910	19479xx
SAF	1057007000	1949005
SAF	1057007100	1949005
SAF	1057212200	15751xx
SAF	1057241000	1737707
SAF	1057241011	1737708
SAF	1057241300	1909437
SAF	1057241310	1909439
SAF	1057241311	1909437
SAF	1057241320	1909440
SAF	1057242200	15751xx
SAF	1057242400	1951513
SAF	1057242409	1951513
SAF	1057242411	1951511
SAF	1057242500	1951512
SAF	1057242509	1951512
SAF	1057242510	1951513
SAF	1057242511	1951513
SAF	1057242520	1951511
SAF	1057243309	19517xx
SAF	1057243400	1951701
SAF	1057243409	1951701
SAF	1057244300	1989202
SAF	1057244300	1989208
SAF	1057244309	1989208
SAF	1057244400	1989208
SAF	1057244410	1989208
SAF	10572843005	1989208
SAF	10572844005	1989208
SAF	1057301000	1737707
SAF	1057301010	1737708
SAF	1057301200	1903230
SAF	1057301210	1903231
SAF	1057301220	1903232
SAF	1057301300	1909437
SAF	1057301310	1909439
SAF	1057301320	1909440
SAF	1057304400	1989208
SAF	1057304410	1989202
SAF	1057306000	1928308
SAF	1057306010	1928309
SAF	1057306100	1928308
SAF	1057306110	1928309
SAF	1057312400	1951512
SAF	1057312410	1951513
SAF	1057312420	1951511
SAF	1057312500	1951512
SAF	1057312510	1951513

MARQUE	REF OES	REFERENCE
SAF	1057312520	1951511
SAF	1057313300	1951701
SAF	1057313310	19517xx
SAF	1057313400	1951701
SAF	1057313410	19517xx
SAF	1057313500	1951701
SAF	1057314300	1989208
SAF	1057314310	1989202
SAF	1057314400	1989202
SAF	1057991200	1903237
SAF	1057991210	1903231
SAF	1057991211	1903230
SAF	1057991220	1903232
SAF	1057996000	1928308
SAF	1057996010	1928309
SAF	1057996100	1928308
SAF	1057996110	1928309
SAF	1057996600	1947706
SAF	1057996610	1947707
SAF	1057996700	1947706
SAF	1057996710	1947707
SAF	1057996800	1947905
SAF	1057996810	19479xx
SAF	1057996900	1947905
SAF	1057996910	19479xx
SAF	1057997000	1949005
SAF	1057997010	19490xx
SAF	1057997100	1949005
SAF	1057997110	19490xx
SAF	3057001300	1909437
SAF	3057001310	1909439
SAF	3057001320	1909440
SAF	3057306000	1928308
SAF	3057306010	1928309
SAF	3057306600	1947706
SAF	3057311200	1903230
SAF	3057311210	1903231
SAF	3057311220	1903232
SAF	3057311320	1909440
SAF	3057312400	1951512
SAF	3057312410	1951513
SAF	3057312420	1951511
SAF	3057313300	1951701
SAF	3057313310	19517xx
SAF	3057314300	1989208
SAF	3057314310	1989202
SAF	3057317000	1949005
SAF	3057391200	1903230
SAF	3057391300	1909437

Les correspondances de références ont pour seul objectif d'aider la recherche de référence

Cross references are there for the sole purpose of helping the reference search

CORRESPONDANCE DES REFERENCES CROSS REFERENCE LIST

MARQUE	REF OES	REFERENCE
SAF	3057392400	1951512
SAF	3057396600	1947706
SAF	3057396800	1947905
SAF	3434365300	1903274
SAF	3434365400	1909474
SCANIA	1100816	RES006
SCANIA	1104544	MAC9932
SCANIA	1104545	MAC9933
SCANIA	11045452	MAC9932
SCANIA	1104548	MAC9932
SCANIA	1104549	MAC9933
SCANIA	1104553	MAC9933
SCANIA	1109002	1993101
SCANIA	1109003	1993201
SCANIA	1116693	MAC9932
SCANIA	1116694	MAC9933
SCANIA	1123136	MAC9932
SCANIA	1123137	MAC9933
SCANIA	1301487	MAC9933
SCANIA	1301913	MAC9933
SCANIA	1304645	AC0039
SCANIA	1304932	1907502
SCANIA	1304933	1939302
SCANIA	1305055	RES006
SCANIA	1309465	RES006
SCANIA	1516501	1993201
SCANIA	1535247	1799101
SCANIA	1535248	1993101
SCANIA	1535249	1993201
SCANIA	1535250	1993301
SCANIA	1535252	1993108
SCANIA	1535253	1993201
SCANIA	1535254	1993301
SCANIA	181814	1939302
SCANIA	245875	MAC9933
SCANIA	246096	MAC9933
SCANIA	276421	MAC9933
SCANIA	322818	MAC9933
SCANIA	355768	MAC9933
SCANIA	372138	AC0039
SCANIA	374355	MAC9933
SCANIA	374358	MAC9933
SCANIA	385948	1993101
SCANIA	385949	1993201
SCANIA	385950	1993301
SCANIA	390544	MAC9933
SCANIA	397051	1799101
SCANIA	397052	1993101
SCANIA	551010	1716101

MARQUE	REF OES	REFERENCE
SCANIA	551019	17161xx
SCANIA	551029	1939302
SCANIA	551036	1939304
SCANIA	551039	1939302
SCANIA	551048	1964702
SCANIA	551049	19647xx
SCANIA	551053	1939302
SCANIA	551057	1716101
SCANIA	551058	1907502
SCANIA	551059	1939302
SCANIA	551061	17161xx
SCANIA	551062	19075xx
SCANIA	551122	1716101
SCANIA	551123	1993101
SCANIA	551124	1993201
SCANIA	551125	1993301
SCANIA	551127	1993102
SCANIA	551128	1993208
SCANIA	551129	1993307
SCANIA	551130	1907502
SCANIA	551131	1939302
SCANIA	551132	1964702
SCANIA	551134	19393xx
SCANIA	551136	1799101
SCANIA	551137	1993101
SCANIA	551138	1993201
SCANIA	551139	1993301
SCANIA	551143	1993202
SCANIA	551160	1799101
SCANIA	551161	1993101
SCANIA	551162	1993201
SCANIA	551163	1993301
SCANIA	551164	17991xx
SCANIA	551165	1993102
SCANIA	551166	1993202
SCANIA	551167	1993307
SCANIA	551168	1716101
SCANIA	551169	1907502
SCANIA	551170	1939302
SCANIA	551171	1964702
SCANIA	551173	19075xx
SCANIA	551174	1939304
SCANIA	551175	19647xx
SCANIA	551179	1993101
SCANIA	551180	1993301
SCANIA	551183	1907502
SCANIA	551184	1964702
SCANIA	551187	1716101
SCANIA	551188	1939302

Les correspondances de références ont pour seul objectif d'aider la recherche de référence

Cross references are there for the sole purpose of helping the reference search

CORRESPONDANCE DES REFERENCES CROSS REFERENCE LIST

MARQUE	REF OES	REFERENCE
SCANIA	551191	1799101
SCANIA	551192	1993201
SCANIA	552110	1799101
SCANIA	552112	1993101
SCANIA	552114	1993201
SCANIA	552115	1993202
SCANIA	552116	1993301
SCANIA	552118	1716101
SCANIA	552120	1907502
SCANIA	552122	1939302
SCANIA	552124	1964702
SCANIA	751011	1939302
SCANIA	751012	1939302
SCANIA	751039	1939302
SISU	5463603213	19144xx
SISU	5463616413	19144xx
SISU	5463616513	19144xx
SMB	AJB0907001	1971802
SMB	M006174	1961313
SMB	M007282	1960870
SMB	M009287	1961313
SMB	M010560	1955713
SMB	M010587	1986201
SMB	M016771	1986202
SMB	M018367	1986202
SMB	M02815	1955713
SMB	M051348	1971802
SMB	M051356	1971802
SMB	M064512	1971802
SMB	M100527	1955713
SMB	M91003501	1955770
SMB	M91003503	1961313
SMB	M91003503	1961370
STEYR	59000340006	1740805
STEYR	59000340714	1708802
STEYR	59000440007	1740806
STEYR	59000440008	1740805
STEYR	59000440707	1740805
TRAILOR	6505111C	1903616
VOLVO	1517824	CR0932
VOLVO	1517825	CR0933
VOLVO	1517834	CR0936
VOLVO	1517835	CR0937
VOLVO	1517941	CR0928
VOLVO	1517942	CR0929
VOLVO	1517952	CR0940
VOLVO	1517953	CR0941
VOLVO	1694361	1907180
VOLVO	1696450	AC0012

MARQUE	REF OES	REFERENCE
VOLVO	1697687	CR0928
VOLVO	1697688	CR0929
VOLVO	1697689	CR0932
VOLVO	1697690	CR0933
VOLVO	1697691	CR0940
VOLVO	1697692	CR0941
VOLVO	1697693	CR0936
VOLVO	1697694	CR0937
VOLVO	1697751	CAM002
VOLVO	1697752	CAM001
VOLVO	21534097	1909002
VOLVO	21534385	1907102
VOLVO	22454041	1949200
VOLVO	270384	1909002
VOLVO	270524	1799201
VOLVO	2705366	1766402
VOLVO	2705374	17664xx
VOLVO	2705382	1956002
VOLVO	2705390	19560xx
VOLVO	2705408	1946703
VOLVO	2705416	19467xx
VOLVO	2705424	1956202
VOLVO	2705432	1956204
VOLVO	2705440	1979901
VOLVO	2705457	1979902
VOLVO	270546	1988501
VOLVO	270547	1988501
VOLVO	270830	1799201
VOLVO	2708303	1799201
VOLVO	270831	17992xx
VOLVO	2708311	1799202
VOLVO	270832	1994102
VOLVO	2708329	1994102
VOLVO	270833	19941xx
VOLVO	2708337	19941xx
VOLVO	270834	1909002
VOLVO	2708345	1909002
VOLVO	270835	1909005
VOLVO	2708353	1909005
VOLVO	270836	1907102
VOLVO	2708361	1907102
VOLVO	270837	1907105
VOLVO	2708370	1907105
VOLVO	2708378	1907105
VOLVO	270838	1906802
VOLVO	2708386	1906802
VOLVO	270839	1906805
VOLVO	2708394	1906805
VOLVO	2709368	1799201

Les correspondances de références ont pour seul objectif d'aider la recherche de référence

Cross references are there for the sole purpose of helping the reference search

CORRESPONDANCE DES REFERENCES CROSS REFERENCE LIST

MARQUE	REF OES	REFERENCE
VOLVO	2709376	1799202
VOLVO	2709382	1994102
VOLVO	2709384	1994102
VOLVO	2709392	19941xx
VOLVO	270940	1909002
VOLVO	2709400	1909002
VOLVO	2709418	1909005
VOLVO	270942	1907102
VOLVO	2709426	1907102
VOLVO	2709434	1907105
VOLVO	2709442	1906802
VOLVO	2709459	1906805
VOLVO	270972	1994102
VOLVO	2709723	1994102
VOLVO	2709731	19941xx
VOLVO	270974	1909002
VOLVO	2709749	1909002
VOLVO	2709757	1909005
VOLVO	270976	1907102
VOLVO	2709765	1907102
VOLVO	2709773	1907105
VOLVO	270978	1906802
VOLVO	2709781	1906802
VOLVO	2709798	1906805
VOLVO	2711026	1938414
VOLVO	2711034	1938415
VOLVO	2711380	1988501
VOLVO	2711398	19885xx
VOLVO	2712495	1938414
VOLVO	2712503	1938415
VOLVO	272515	1766402
VOLVO	2725150	1766402
VOLVO	2725158	1766402
VOLVO	272516	1946703
VOLVO	2725166	1946703
VOLVO	272522	1956002
VOLVO	2725224	1956002
VOLVO	272523	1956202
VOLVO	2725232	1956202
VOLVO	2725281	1956002
VOLVO	2725299	1956202
VOLVO	2725455	1766402
VOLVO	272546	17664xx
VOLVO	2725463	17664xx
VOLVO	272549	1956002
VOLVO	2725497	1956002
VOLVO	272550	19560xx
VOLVO	2725505	19560xx
VOLVO	272552	1956204

MARQUE	REF OES	REFERENCE
VOLVO	272564	17664xx
VOLVO	2725646	17664xx
VOLVO	2725653	19467xx
VOLVO	272584	19560xx
VOLVO	2725844	19560xx
VOLVO	2725851	1956204
VOLVO	272603	17804xx
VOLVO	272609	19622xx
VOLVO	272614	1782704
VOLVO	2726149	1782704
VOLVO	272615	1782704
VOLVO	272621	1962004
VOLVO	2726214	1962004
VOLVO	272622	1962005
VOLVO	272649	17829xx
VOLVO	2726495	17829xx
VOLVO	272651	1783102
VOLVO	2726511	1783102
VOLVO	272652	1783102
VOLVO	272672	19560xx
VOLVO	2726727	19560xx
VOLVO	2726933	1766402
VOLVO	272694	1956002
VOLVO	2726941	1956002
VOLVO	2727105	1979901
VOLVO	2727113	1979902
VOLVO	272714	17804xx
VOLVO	2727147	17804xx
VOLVO	272716	19622xx
VOLVO	2727163	19622xx
VOLVO	2727170	19622xx
VOLVO	272724	1938414
VOLVO	2727246	1938414
VOLVO	272734	1946703
VOLVO	2727345	1946703
VOLVO	272735	19467xx
VOLVO	2727352	19467xx
VOLVO	272736	1956202
VOLVO	2727360	1956202
VOLVO	272737	1956204
VOLVO	2727378	1956204
VOLVO	2727428	17664xx
VOLVO	2727436	19560xx
VOLVO	2727444	1946703
VOLVO	2727451	19467xx
VOLVO	2727460	1956202
VOLVO	2727469	1956202
VOLVO	2727477	1956204
VOLVO	2727485	1979901

Les correspondances de références ont pour seul objectif d'aider la recherche de référence

Cross references are there for the sole purpose of helping the reference search

CORRESPONDANCE DES REFERENCES CROSS REFERENCE LIST

MARQUE	REF OES	REFERENCE
VOLVO	2727493	1979902
VOLVO	272754	1956002
VOLVO	272755	19560xx
VOLVO	2727857	1766402
VOLVO	2727865	17664xx
VOLVO	2727873	1946703
VOLVO	2727881	19467xx
VOLVO	272806	1988501
VOLVO	2728061	1988501
VOLVO	2728079	19885xx
VOLVO	2728491	1938415
VOLVO	2728863	1988501
VOLVO	2728871	19885xx
VOLVO	2728889	1956002
VOLVO	2728897	19560xx
VOLVO	272890	1946703
VOLVO	2728905	1946703
VOLVO	2728913	19467xx
VOLVO	272892	1956202
VOLVO	2728921	1956202
VOLVO	272893	1956204
VOLVO	2728939	1956204
VOLVO	2728947	1979901
VOLVO	2728954	1979902
VOLVO	272910	AC0001
VOLVO	275883	1946703
VOLVO	2759900	1799201
VOLVO	2759918	1799202
VOLVO	2759926	1994102
VOLVO	2759934	19941xx
VOLVO	2759942	1909002
VOLVO	2759959	1909005
VOLVO	2759967	1907102
VOLVO	2759967	1909002
VOLVO	2759975	1907105
VOLVO	2759983	1906802
VOLVO	2759991	1906805
VOLVO	2760403	1766402
VOLVO	2760411	17664xx
VOLVO	2760429	1956002
VOLVO	2760437	19560xx
VOLVO	2760445	1946703
VOLVO	2760452	19467xx
VOLVO	2760460	1956202
VOLVO	2760478	1956204
VOLVO	2760486	1979901
VOLVO	2760494	1979902
VOLVO	2760502	1988501
VOLVO	2760510	19885xx

MARQUE	REF OES	REFERENCE
VOLVO	276097	AC0003
VOLVO	276098	AC0004
VOLVO	276100	AC0002
VOLVO	3090044	1954201
VOLVO	30900443	1954201
VOLVO	3090343	1799201
VOLVO	30903439	1799201
VOLVO	30903447	1799202
VOLVO	3090345	1994102
VOLVO	3090346	1906805
VOLVO	3090347	1909002
VOLVO	3090348	1909005
VOLVO	3090349	1907102
VOLVO	3090350	1907105
VOLVO	3090351	1906802
VOLVO	30903512	1906802
VOLVO	3090352	1906805
VOLVO	3090954	AC0014
VOLVO	3090964	AC0002
VOLVO	30912828	1979901
VOLVO	30912836	1979902
VOLVO	30912844	1988501
VOLVO	3091438	1975803
VOLVO	30914527	1799201
VOLVO	30914535	1799202
VOLVO	3091458	1907102
VOLVO	3091488	1735702
VOLVO	3091581	1906802
VOLVO	3091795	AC0015
VOLVO	3092465	SUP001
VOLVO	3092466	SUP002
VOLVO	3092693	1946703
VOLVO	3092694	1956202
VOLVO	3092695	1979901
VOLVO	3093259	1907102
VOLVO	3093260	1907105
VOLVO	3093261	1906802
VOLVO	3093262	1906805
VOLVO	3093263	1907102
VOLVO	3093264	1907105
VOLVO	3093265	1906802
VOLVO	3093266	1906805
VOLVO	3095163	1799201
VOLVO	3095164	1799202
VOLVO	3095165	1994102
VOLVO	3095167	1909002
VOLVO	3095169	1907102
VOLVO	3095170	1907105
VOLVO	3095171	1906802

Les correspondances de références ont pour seul objectif d'aider la recherche de référence

Cross references are there for the sole purpose of helping the reference search

CORRESPONDANCE DES REFERENCES CROSS REFERENCE LIST

MARQUE	REF OES	REFERENCE
VOLVO	3095172	1906805
VOLVO	3095173	1799201
VOLVO	3095174	1799201
VOLVO	3095175	1994102
VOLVO	3095176	1994102
VOLVO	3095177	1909002
VOLVO	3095178	1909002
VOLVO	3095179	1907102
VOLVO	3095180	1907105
VOLVO	3095181	1906802
VOLVO	3095182	1906805
VOLVO	3095187	1909002
VOLVO	3095189	1907102
VOLVO	3095193	MAC7992/2
VOLVO	30951935	MAC7992/2
VOLVO	3095194	MAC9941/2
VOLVO	3095195	MAC9090/2
VOLVO	3095196	MAC9071/2
VOLVO	3095197	MAC9068/2
VOLVO	3095203	CAM009
VOLVO	3095204	CAM010
VOLVO	3097092	AC0013
VOLVO	3097167	1946703
VOLVO	3097168	1956202
VOLVO	3097169	1979901
VOLVO	30971691	1979901
VOLVO	30971725	1979902
VOLVO	3097175	1766402
VOLVO	3097177	1956002
VOLVO	3097275	1907102
VOLVO	3097276	1906802
VOLVO	3097278	1907102
VOLVO	3097279	1906805
VOLVO	3097435	1964001
VOLVO	3097435	1975803
VOLVO	3097500	19640xx
VOLVO	3098082	19975xx
VOLVO	3098264	1909002
VOLVO	3098265	1909005
VOLVO	3098266	1906802
VOLVO	3098267	1906805
VOLVO	85104191	MAC9090/2
VOLVO	85105382	1909002
VOLVO	85105383	1907102
VOLVO	8550977	AC0005
VOLVO	8550978	AC0006
WABCO	12739085VT	ECF003
WABCO	12739086VT	ECF004
WABCO	12999287VT	KRES011

MARQUE	REF OES	REFERENCE
WABCO	12999410VT	CAC036
WABCO	12999411VT	CAC037
WABCO	12999418VT	CAC038
WABCO	12999469VT	1950378
WABCO	12999573VT	KRES008
WABCO	12999623VT	KRES007
WABCO	12999709	1909978
WABCO	12999711	1909178
WABCO	13057005	15304xx
WABCO	13057142	19730xx
WABCO	13057170	1978612
WABCO	13057181	19170xx
WABCO	13057190	1978611
WABCO	13057191	1982410
WABCO	13057192	1982410
WABCO	13057193	1503002
WABCO	13057194	1503002
WABCO	13057196	1708802
WABCO	13057197	1708802
WABCO	13057198	19821xx
WABCO	13057199	19224xx
WABCO	13057200	17098xx
WABCO	13057201	1792408
WABCO	13057202	1792408
WABCO	13057220	19786xx
WABCO	13057221	1978612
WABCO	13057225	1922507
WABCO	13057232	13013xx
WABCO	13057242	15839xx
WABCO	13057265	19225xx
WABCO	13057307	19592xx
WABCO	13057312	19586xx
WABCO	13057350	1978611
WABCO	13057445	1709401
WABCO	13057451	17098xx
WABCO	13057453	17098xx
WABCO	13057457	19224xx
WABCO	13057493	15304xx
WABCO	13057502	1709601
WABCO	13057503	1709601
WABCO	13057522	1950308
WABCO	13057550	11027xx
WABCO	13057648	15178xx
WABCO	13057649	15179xx
WABCO	13057687	15304xx
WABCO	13057689	19857xx
WABCO	13057778	15313xx
WABCO	13157313	19730xx
WABCO	13157860	15304xx

Les correspondances de références ont pour seul objectif d'aider la recherche de référence

Cross references are there for the sole purpose of helping the reference search

Français	Anglais	Allemand	Italien	Espagnol
A l'origine garnitures vissés	initial screwed pads	ursprüngl. verschraubte Beläge	pastiglie freno avvitata in origine	pastillas inicialmente montadas
Abîmer	Damage	Beschädigt	Danno, guasto	Daño
Abrasion	Abrasion	Abrieb	Abrasione	Abrasión
ABS (système antiblocage)	ABS (anti-lock brake system)	ABS	ABS (sistema antibloccaggio in frenata)	ABS (sistema de frenado antibloqueo)
Ajustage automatique	Automatic adjustment	automatische Nachstellung	correzione automatica	reajuste automatico
Âme détériorée	Damaged web	Beschädigter Bremsbackensteg	Costa danneggiata	Alma, nervio dañado
Âme, âme de mâchoire	Web, shoe web	Bremsbackensteg	Costa (nervatura) di ganascia	Alma, nervio de la mordaza, zapata alma, nervio
Aspect du cisaillement	Shear pattern	Scherbild	Figura di distacco	Útil de cizallar
Assistance pneumatique	Air brake assistance	Druckluftunterstützung	comando aria compressa	freno de aire auxiliár
AV (essieu avant)	FA (front axle)	VA (Vorderachse)	A (asse anteriore)	VA (eje delantero)
Avec contrôle de ralentisseur	With retarder control	Mit Retardersteuerung	Con controllo retarder	Controlada joroba
Bancs d'essai de freinage	Brake test benches	Bremsenprüfstände	Banchi prova freni	Banco de pruebas para frenos
Bande de garniture rigide	Brake band rigid lining	Bremsband fest	Guarnizione per freno a nastro	Forro de banda rígida
Bande moulée	Roll lining	Bremsband gerollt (flexibel)	Materiale d'attrito (guarnizione) in rotolo	Cinta flexible
Boulette de fibres	Fibber concentrate	Faseransammlung	Grumo di fibra	Bolas de fibra
Broutement	Grabbing	Verzahnen	Traballare	Resalte, agarre
Broutement à chaud	Hot judder	Heissrubbeln	Traballamento	Hot judder, vibración
Broutement à froid	Cold judder	Kaltrubbeln	Vibrazione a freddo	Cold judder, vibración
Bruit	Noise	Geräusch	Rumore	Ruido
Bruit de dé freinage	Creep groan	Knarzen/knurren	Ruvidità a freddo	Creep groan
Bruit de freinage	Brake noise	Bremsgeräusch	Rumore in frenata	Ruido de frenada
Câble de frein de parking	Hand brake actuation	Handbremsbetätigung	azionamento freno a mano	activación de freno de mano
Calibres pour diamètres intérieurs	Plug gauges	Meßdorne	Calibri di misura	Calibres
Cannelure type	Spline type	Zahnradnaben-Type	Tipo chiavetta	Tipo de ranura
Capteur de roue	Wheel sensor	Radsensor	seniore ruota	seniore de rueda
Capteurs de Vitesse	Wheel Speed Sensors	Drehzahlsensoren	Sensori di Velocità	Sensores de velocidad
Catalogues	Catalogues	Kataloge	Cataloghi	Catálogos
Certificat	Certificate	Zertifikat	Certificato	Certificado
Certification	Authentication, Certification	Beglaubigung, Zertifizierung	Autenticazione, Certificazione	Certificación
Chanfrein	Chamfer	Anschrägung	Smusso	Chaflán
Clivage	Delamination	Schichtbildung	Delaminazione, sfaldatura	Exfoliación
Compressibilité	Compressibility	Kompressibilität	Compressibilità	Compresibilidad
Conduite à droite	Right hand drive	Rechtslenker	Guida a destra	Con volante a la derecha
Conduite à gauche	Left hand drive	Linkslenker	Guida a sinistra	Con volante a la izquierdo
Conduites de frein	Brake lines	Bremsleitungen	Condutture freno	Líneas/mangueras de frenos
Contrôle	Control	Überwachung	Controllo, collaudo	Control

Français	Anglais	Allemand	Italien	Espagnol
Contrôle final	Final inspection	Endprüfung	Ispezione finale	Control final
Contrôle pression frein de parc	Pressure from spring brake system	Druck vom Feststellbremssystem	Pressione dal circuito di stazionamento	Control de presión de freno de estacionamiento
Contrôle visuel	Visual inspection	Sichtprüfung	Ispezione visiva	Inspección visual
Contrôle, vérification	Check	Überprüfen	Controllo	Control, verificación
Correcteurs de Freinage Suspension Mécanique	Load Sensing Valves Mechanical Suspension	Bremskraftregler mechanisch	Correttori di Frenata Meccanici	Correctores de frenado Suspensión Mecánica
Correcteurs de Freinage Suspension Pneumatique	Load Sensing Valves Air Suspension	Bremskraftregler, pneumatisch	Correttori di Frenata Pneumatici	Correctores de frenado Suspensión neumática
Couple résiduel de freinage	Residual brake drag	Restlicher Bremswiderstand	Momento residuo	Par residual
CR (cylindre roue)	WC (wheel cylinder)	Rz (Radzylinder)	cil. ruota (cilindretto ruota)	CR (cilindro de rueda)
Cylindres à Ressort	Spring Brakes	Kombizylinder	Cilindri Doppi	
Cylindres de freins de roues	Wheel brake cylinders	Bremszylinder	Cilindret	Cilindros de frenos
Dessiccateurs d'air comprimé	Compressed-air dryers	Drucklufttrockner	Deumidificatori per aria compressa	Secadores de aire comprimido
Diamètre du cercle de rivetage	Pitch circle diameter	Lochkreisdurchmesser	Diametro di foratura	Diámetro entre agujeros de remache
Diamètre extérieur	Outside diameter	Aussendurchmesser	Diametro esterno	Diámetro exterior
Diamètre intérieur	Inside diameter	Innendurchmesser	Diametro interno	Diámetro interior
Diamètre moyen	Inner/core diameter	Innendurchmesser	Diametro mediano	Diámetro medio
Dimension des trous	Hole sizes	Bohrungsdurchmesser	Dimensione del foro	Tamaño del agujero
Ébauche d'usinage	Pregrinding	Vorschleifen	Pre-rettifica	Pre-rectificado
Encollage	Adhesive coating	Kleberbeschichtung	Copertura adesiva	Recubrimiento adhesivo
Enregistreurs de pression de freinage	Brake pressure recorders	Bremsdruckschreiber	Pressografo per impianto freni	Impresora para presión de frenado
Enregistreurs du taux de freinage	Brake rate recorders	Bremsverzögerungsmesser	Decelerometro	Medidores de desaceleración de frenado
Épaisseur de la tête	Head thickness	Kopfdicke	Spessore della testa	Espesor de la cabeza
Épaisseur minimum	Thickness minimum	Dicke, min	Spessore minimo	Espesor mínimo
Essai d'usure	Wear test	Verschleißprüfung	Prova di usura	Ensayo de desgaste
Essieu arrière	Rear axle	Hinterachse	Asse posteriore	Eje posterior
Essieu avant	Front axle	Vorderachse	Asse anteriore	Eje anterior
Essieu multi-link	Multi-link axle	Multi-Link-Achse	assale Multi-link	eje Multi-Link
Essieux	Axles	Achsen	Assali	Ejes
Essieux de remorques	Trailer axles	Anhängerachsen	Assi per rimorchi	Ejes para remolques
Étalonnage	Calibration	Kalibrieren	Taratura	Calibrado
Face de friction	Friction surface, Working surface	Reibfläche	Superficie di lavoro	Superficie de fricción
Fading (évanouissement)	Fading	Fading	Fading, affievolirsi	Fading
Fil témoin d'usure	Wear indicator cable	Kabel für Verschleissanzeiger	Cavetto indicatore d'usura	Cable del indicador de desgaste
Flasque	Flange	Flansch	Flangia	Pestaña
Flexibles	Hoses	Schläuche	Tubi flessibili	Cámaras
Fraisée	Hole milling machines	Lochfräser	Frese frontali	Fresadoras de agujero
Frein à main	Hand brake	Handbremse	Freno a mano	Freno de mano

Français	Anglais	Allemand	Italien	Espagnol
Frein à tambour	Drum brake	Trommelbremse	freni a tamburo	tambores de freno
frein à tambour essieu AR	Rear axle drum brake	HA-Trommelbremse	tamburi freno asse posteriore	eje trasero tambores de freno
Frein pneumatique	Air brake	Druckluftbremse	freno pneumatico	freno de aire comprimido
Freinage irrégulier	Uneven braking	Ungleichmäßiges Bremsen	Sbilanciamento in frenata	Balance de frenada no correcto
Freins	Brakes	Bremsen	Freni	Frenos
Freins à disque	Disk brakes	Scheibenbremsen	Freni a disco	Frenos a disco
Freins à Disque Pneumatique	Air Disc Brakes	Pneumatische Scheibenbremsen	Freni a Disco Pneumatici	Freno de disco neumático
Freins à tambours	Drum brakes	Trommelbremsen	Freni a tamburo	Frenos de tambor
Freins de remorques	Trailer brakes	Anhängerbremsen	Freni per rimorchi	Frenos para remolques
Garantie	Warranty	Garantie	Garanzia	Garantía
Garniture	Lining	Reibbelag	Guarnizione (suola)	Forro
Garniture chanfreinée	Chamfered lining	Abgeschrägter Belag	Ceppo (suola) smussato	Forro chaflanado
Garniture collée	Bonded lining	Geklebter Belag	Ceppo (suola) incollato	Forro encolado
Garniture de frein	Brake lining	Bremsbelag	Ceppo (suola) per freno	Forro de freno
Garniture de frein à tambour	Drum brake lining	Trommelbremsbelag	Guarnizione per freno a tamburo	Forro de freno de tambor
Garniture moulée	Moulded lining	Gepresster Belag	Guarnizione stampata	Forro moldeado
Garniture rivetée	Riveted lining	Genieteteter Belag	Guarnizione rivettata	Forro remachado
Garniture tissée	Woven material	Gewebtes Material	Ceppo di materiale tessuto	Material tejido
Garnitures de frein à tambour	Drum Brake Linings	Trommelbremsbeläge	Guarnizioni per freni a tamburo	Forros de freno de tambor
Garnitures de friction	Friction linings	Reibbeläge	Ferodi	Guarniciones de fricción
Gauche	Left	Links	Sinistra	Izquierdo
Glaçage	Glazing	Verglasung	Aspetto vetroso	Aspecto vidrioso
Goupilles	Splints, Pins	Splinte, Stifte	Copiglie, Perni	Grupillas, Pasadores
Gravage	Impression stamping	Prägen	Incisione	Troquelado
Grésillement	Chirp	Zirpen	Pigolio	Chirrido
Grondement	Rumble	Rumpeln, rütteln	Risonanza	Vibración
Groupe de pièces normalisées	Standard parts	Gruppe Normteile	Gruppo pezzi standardizzati	Grupo de piezas normalizadas
Grues mobiles	Mobile cranes	Mobilkrane	Gru mobili	Grúas móviles
Hydraulique	Hydraulic	Hydraulisch	Idraulica	Hidráulica
Jauges d'épaisseur	Feeler gauges	Tastlehren	Calibri tastatori	Patrones para palpar
L (longueur) =	L (length) =	L (Länge) =	L (lunghezza) =	L (largo) =
Largeur totale	Overall width	Gesamtbreite	Larghezza totale	Anchura total
Levier à Droite	Right hand	Hebel rechts	Azionamento leva destra	
Levier à Gauche	Left hand	Hebel Links	Azionamento leva sinistra	
Limiteurs de la force de freinage	Brake power limiters	Bremskraftbegrenzer	Limitatore di frenata	Reductor de servofreno
Limiteurs de vitesse	Engine speed governors	Drehzahlbegrenzer	Limitatori di velocità	Limitadores de la velocidad
Liquide de frein	Brake fluid	Bremsflüssigkeit	Liquido freni	Liquido de frenos
Mâchoire détériorée	Damaged shoe	Beschädigte Bremsbacke	Ganascia danneggiata	Mordaza, zapata dañada

Français	Anglais	Allemand	Italien	Espagnol
Mâchoire primaire	Primary lining	Primärbelag	Ceppo (suola) primaria	Mordaza, zapata primaria
Mâchoire secondaire	Secondary lining	Sekundärbelag	Ceppo (suola) secondario	Mordaza, zapata secundaria
Mâchoire tendue	Trailing shoe	Ablaufbacke	Ganascia svolgente	Mordaza, zapata extendida
Mâchoires de frein	Brake shoes	Bremsbacken	Ganasce Freno	Zapatas de freno
Mâchoires de frein à tambour garnies	Shoe assembly	Trommelbremsbacken mit Belag	Ganasce per freno a tamburo	Conjunto para freno de tambor
Matériau de friction	Friction material	Reibmaterial	Materiale d'attrito	Material de fricción
Matériau déporté sur le support	Material out of position on the plate	Belagversatz auf Trägermaterial	Materiale scentrato rispetto al supporto	Material descentrado respecto al soporte
Micro fissure	Hairline crack	Mikrofeiner Riss	Fessura sottile	Fisura superficial
Norme	Standard	Norm	Norma	Norma
Performance de freinage	Braking performance	Bremsleistung	Efficienza di frenata	Prestaciones de frenada
Pièces de freins	Brake parts	Bremsen-Bauteile	Componenti freno	Piezas de frenos
Pièces détachées de freins à disque	Disc brake parts	Scheibenbremsen-Bauteile	Particolari per freni a disco	Piezas para frenos de disco
Pièces détachées de freins à tambours	Drum brake parts	Trommelbremsen-Bauteile	Particolari per freni a tamburo	Piezas para frenos de tambor
Pieds à coulisse	Calliper gauges	Meßschieber	Calibri a corsoio	Deslizadores de medición
Politique qualité	Quality policy	Qualitätspolitik	Politica della qualità	Política de calidad
Purge	Purge	Regeneration	Scarico	Purga
Quantité	Quantity	Menge	Quantità	Cantidad
Rectifieuses de bandes de roulement	Tire tread levelling machines	Egalisiermaschinen	Macchine pareggiatrici	Máquinas para equiparar neumáticos
Rectifieuses de surface	Surface grinders	Planschleifmaschinen	Spianatrici	Máquinas de afilado plano
Rectifieuses mâchoires et garnitures de freins	Brake shoe and lining grinders	Bremsbacken- und Bremsbelag-Schleifmaschinen	Rettificatrici per ceppi e guarnizioni freno	Máquinas para afilar mordazas y forros de frenos
Redan, épaulement	Under hang	Absatz	Sporgenza della piastrina	Desplazamiento, entrante
Réducteurs de Pression	Pressure Proportioning Valves	Druckwandler	Riduttori di Pressione Proporzionali	
Référence du matériau	Material reference	Materialbezeichnung	Marcatura di identificazione	Referencia
Régulateur de freinage	Regulator	Regler	correttore di frenata	regulador
Régulateurs	Regulators	Regler	Regolatori	Reguladores
Régulateurs de la force de freinage	Brake power regulators	Bremskraftregler	Regolatore di frenata	Regulador de servofreno
Réservoir	Reservoir	Behälter	serbatoio	recipiente
Ressorts	Springs	Federn (Motor, Fahrwerk)	Linguette, Molle, Molletta	Amortiguadores, Muelles
Revêtement anti-bruit	Anti-noise material	Dämpfungsmaterial	Guarnizione antivibrante sul supporto	Recubrimiento anti-ruido montado
Rivet	Rivet	Niete	Rivetto	Remache
Riveteuses de garnitures de freins	Brake lining riveting machines	Bremsbelag-Nietmaschinen	Rivettatrici per guarnizioni freno	Máquinas para remachar forros de frenos
Rivets	Rivets	Niete	Ribattini	Remaches
Robinets de Commande à main	Handbrake Valves	Handbremsventile	Distributoria mano	

Français	Anglais	Allemand	Italien	Espagnol
Roue	Wheel	Rad	ruota	rueda
Roue jumelée	Twin tyres	Doppelbereifung	ruote gemellate	cubierta doble
Roue simple	Single tyre	Einfachbereifung	ruota singola	cubierta simple
Roues	Wheels	Räder	Ruote	Ruedas
Roues dentées	Gears	Zahnräder	Ingranaggi	Ruedas dentadas
Rouleau moulé	Moulded roll	Gepresstes Band	Rotolo stampato	Cinta moldeada
Semelle détériorée	Damaged platform	Beschädigtes Auflageblech	Fascia danneggiata	Llanta, pista dañada
SGT (mâchoires de frein à tambour)	DBS (drum brake shoes)	TBB (Trommelbremsbacken)	ganasce freno	ZDF (zapatas de freno)
Sortie hydraulique	Hydraulic output	Hydraulischer Ausgang	Uscita idraulica	
Système antiblocage (ABS)	Anti-lock braking system (ABS)	Antiblockiersystem (ABS)	Sistema antibloccaggio (ABS)	Sistema de frenado antibloqueo
Tambour de frein	Brake drum	Bremstrommel	Tamburo per freno	Tambor de freno
Tambours de freins	Brake drums	Bremstrommeln	Tamburi freno	Tambores de freno
Témoin d'usure	Wear indicator	Verschleissanzeiger	Indicatore d'usura	Indicador de desgaste
Témoin d'usure mécanique	Screech wear indicator	Kratzblech	Indicatore a vibrazione	Testigo de desgaste mecánico
Témoins	Tell-tales	Kontroll-Leuchten	Spie di controllo	Luces de control
Témoins d'usure de garnitures de freins	Brake lining wear tall-tales	Bremsbelag-Verschleißanzeiger	Indicatore consumo ferodi	Indicador de desgaste de guarniciones de frenos
Testeurs de freins	Brake testers	Bremsenprüfgeräte	Apparecchi controllo freni	Aparatos para prueba de frenos
Testeurs de pression de frein	Brake pressure testers	Bremsdruckprüfgeräte	Apparecchi prova pressione freni	Aparatos para prueba de presión de frenado
Tours et rectifieuses pour tambours et disques de freins	Brake drum and disc turning and grinding machines	Bremstrommel- und Brems Scheiben-Dreh- und Schleifmaschinen	Torni e rettifiche per tamburi e dischi freno	Máquinas de torneado y afilado
Tours pour garnitures de freins	Brake lining lathes	Bremsbelag-Abdrehmaschinen und -geräte	Torni ed attrezzi per ripassaggio guarnizioni freno	Máquinas y equipos para tornear forros de freno
Trou de lamage conique	Tapered counter bore hole	Senkloch konisch	Foro conico con bassofondo piano	Agujero avellanado cónico de fondo plano
Trou de lamage droit	Straight counter bore hole	Senkloch zylindrisch	Foro piano con bassofondo piano	Agujero avellanado recto de fondo plano
Trou de lamage plan	Counter bore	Zylindrische Ansenkung	Foro con bassofondo piano	Avellanado de base plana
Trou de positionnement	Locating hole	Halteloch	Foro di posizionamento	Agujero de centraje
Trou de rivet	Rivet hole	Nietlöcher	Fori di rivettatura	Agujero de remache
Trou fraisé	Counter sunk hole	Nietboden konisch	Foro piano con bassofondo conico	Agujero avellanado recto de fondo cónico
Trou rivet matière	Spigot hole	Arretierungsloch	Foro degli spinotti	Agujero de anclaje
Trous de rivet	Rivet holes	Nietlöcher	Fori di rivettatura	Agujeros de remache
Type de frein	Brake type	Bremsentyp	Tipo di freno	
Valves de Contrôle	Control Valves	Wegeventile	Valvole di Controllo	
Valves de Desserrage	Manoeuvring Valves	Löseventile	Rubinetti di Sfrenatura	
Valves de Desserrage	Park/Shunt Valves	Park-/Rangierventile	Valvole di Sfrenatura	
Valves de Desserrage Rapide	Quick Release Valves	Schnelllöseventile	Valvoledi Scarico Rapido	
Valves de Nivellement	Levelling Valves	Lufffederungsventile	Valvole Livellatrici	
Valves de Purge	Drain Valves	Entwässerungsventile	Valvole di Spurgo	
Valves Relais	Relay Valves	Relais ventile	Valvole Relé	

**GIL Automotive remet à jour la documentation sur le site
GIL Automotive will update the documentation on the site**

www.GiL-Automotive.com

Avis de non-responsabilité

Les marques désignées sont des marques déposées par leurs propriétaires respectifs. GIL Automotive n'est en aucun cas liée, affiliée ou associée aux propriétaires de ces marques. Les produits de GIL Automotive présentés dans ce document ne sont ni recommandés ni autorisés par les propriétaires de ces marques.

Disclaimer

The designated trademarks are registered marks of their respective owners and GIL Automotive is not commercially connected, affiliated, or associated with any of the owners of such marks. The GIL Automotive products presented herein are not endorsed or authorized by any of the trademark owners.

Cachet du distributeur / Distributor stamp

