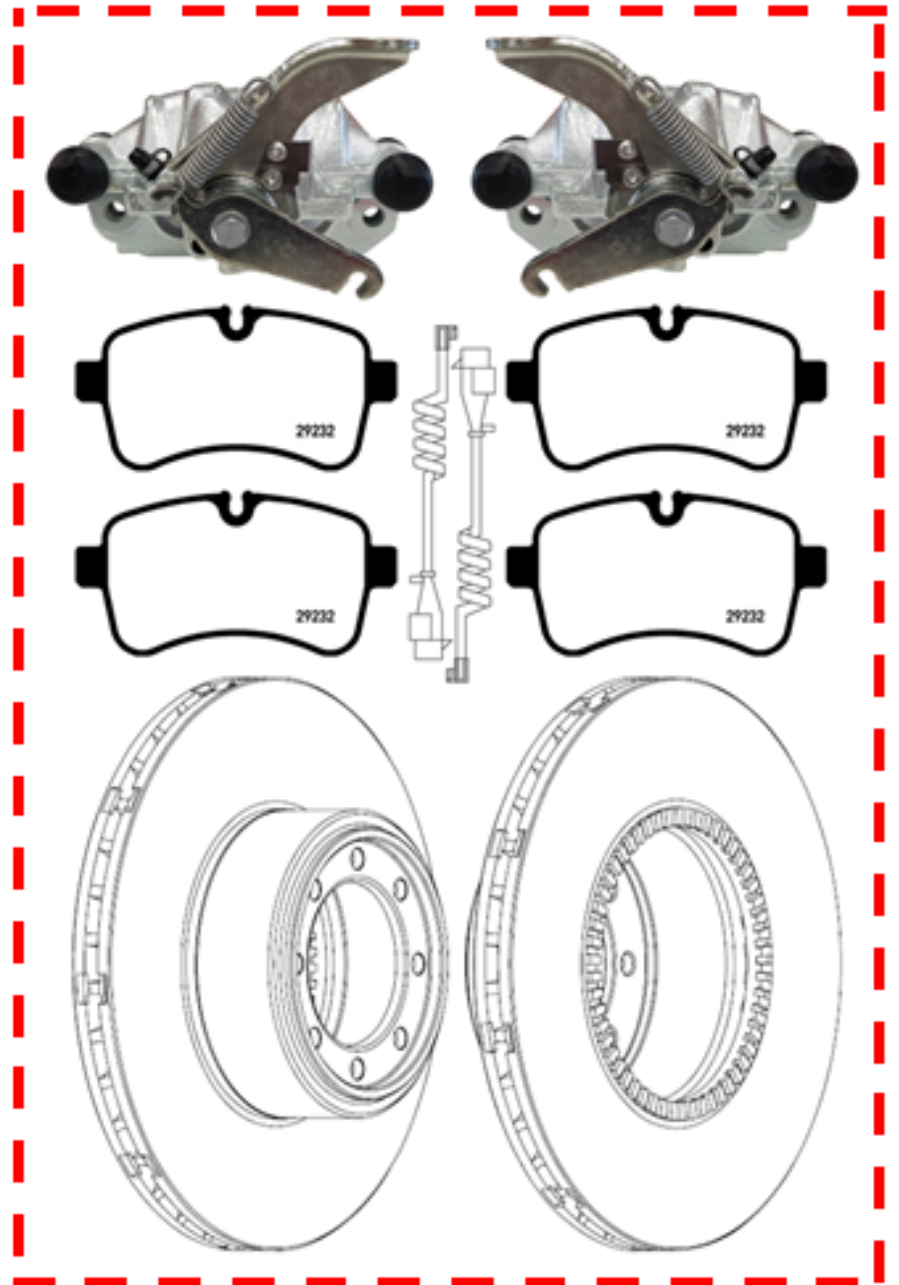
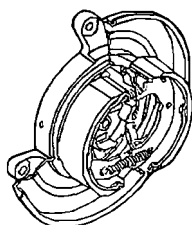
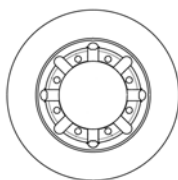




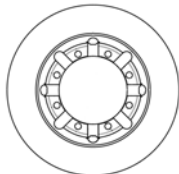
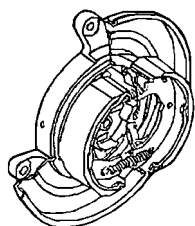
NOUVEAU / NEW

Pages 6-20





	SOMMAIRE	2
	INTRODUCTION	3
	ABBREVIATIONS	4
	TUTORIEL D'UTILISATION DU CATALOGUE	5
	NOUVEAUTES PRODUITS	6-20
	CLASSIFICATION ETRIER DE FREIN	21-45
	RECHERCHE PLAQUETTES DE FREIN /DIMENSIONS	46-60
	RECHERCHE DISQUES DE FREIN /DIMENSIONS	61-74
	MAÎTRES CYLINDRES	75-77
	FREINAGE A DISQUE	78-116
	CABLES DE FREIN A MAIN	117-118
	FREIN DE PARKING	119-120
	ILLUSTRATIONS	121
	FREIN A TAMBOURS	122-126
	CORRESPONDANCE DES REFERENCES	127-170
	TRADUCTION	171
	AVIS DE NON-RESPONSABILITE	172
	CONTENTS	2
	INTRODUCTION	3
	ABBREVIATION	4
	HOW TO USE THE CATALOG	5
	PRODUCT NEWS	6-20
	BRAKE CALIPER CLASSIFICATION	21-45
	BRAKE PADS RESEARCH BY SIZE	46-60
	BRAKE DISC RESEARCH BY SIZE	61-74
	MASTER CYLINDER	75-77
	BRAKE DISC SYSTEM	78-116
	BRAKE CABLES	117-118
	HANDBRAKE SYSTEM	119-120
	DRAWING	121
	BRAKE DRUM SYSTEM	122-126
	CROSS LIST	127-170
	TRANSLATION	171
	DISCLAIMER	172



INTRODUCTION

Ce catalogue a pour but d'améliorer la productivité au niveau de la recherche de pièces. Les pièces sont associées : étrier gauche, étrier droit, les plaquettes, les témoins d'usure, les disques de frein et éventuellement les flasques de frein de parking sur la même ligne.

On peut également rechercher les plaquettes de frein par la largeur et la hauteur ; les étriers par le type, le nombre de piston et le diamètre.

On peut bien entendu faire une recherche par modèle de véhicule et également par la référence d'origine du constructeur.

Ce nouveau catalogue intègre les illustrations des mâchoires de frein de parking et une traduction en 4 langues (Anglais, Allemand, Italien et Espagnol).



This catalog is designed to improve productivity in research of spare parts. Parts are linked: left caliper, right caliper, brake pads, wears indicators, brake discs and eventually the parking brake on the same line.

Pads search can also be done through width and height; caliper by type, number and diameter of the piston.


Of course, search can be proceeded by car model and also by OEM part number.


This new catalogue includes parking brake shoes drawings and a translation in 4 languages (English, German, Italian and Spanish).

ABBREVIATION	Français	English
ABS-	SANS ABS	WITHOUT ABS
ABS+	AVEC ABS	WITH ABS
AR	ESSIEU ARRIERE	REAR AXLE
AV	ESSIEU AVANT	FRONT AXLE
AV/AR	ESSIEU AVANT ET ARRIERE	FRONT AND REAR AXLE
P	ETRIER FIXE	FIXED CALIPER
PC	ETRIER FIXE COMMANDE PARKING	FIXED CALIPER WITH PARKING BRAKE
PF	ETRIER FLOTTANT	FLOATING CALIPER
PFC	ETRIER FLOTTANT COMMANDE PARKING	FLOATING CALIPER WITH PARKING BRAKE
TU+	AVEC TEMOINS D'USURE	WITH WEAR INDICATOR

EXPLICATIONS DES REFERENCES / PARTS NUMBERS EXPLANATION

08.xxxx.xx	DISQUE PLEIN BREMBO	SOLID DISC BREMBO
09.xxxx.xx	DISQUE VENTILE BREMBO	VENTED DISC BREMBO
20/29xxx7x	PLAQUETTES DE FREIN TEXTAR AVEC TU	BRAKE PADS WITH WEAR INDICATOR
20/29xxxxx	PLAQUETTES DE FREIN TEXTAR	BRAKE PADS TEXTAR
507.xxxx.xx	PLAQUETTES ET TU BREMBO	BRAKE PADS AND WEAR INDICATOR BREMBO
527.xxxx.xx	FLASQUE PARKING BREMBO	COMPLETE PARKING BRAKE
9xxxxxxx	DISQUE DE FREIN TEXTAR	BRAKE DISC TEXTAR
CFMxxx	CABLE DE FREIN A MAIN	PARKING BRAKE CABLES
CRBxxx	CYLINDRE DE ROUE BORGNE	WHEEL CYLINDER (1 PISTON)
CRxxxx	CYLINDRE DE ROUE	WHEEL CYLINDER
EFNxxx	ETRIER FREIN NEUF	NEW BRAKE CALIPER
EFRxxx	ETRIER FREIN REVALORISE	REMANUFACTURED CALIPER
FLxxxx	FLASQUE FREIN SERVICE	COMPLETE BRAKE
KAxxxx	KIT ACCESSOIRES	FITTING KIT
KBxxxx	KIT BAGUES ETANCHEITE	SEAL KIT
KF60xx	KIT DE FREIN SYST. BENDIX	BRAKE KIT BENDIX SYS.
KF61xx	KIT DE FREIN SYST. BOSCH	BRAKE KIT BOSCH SYS.
KF62xx	KIT DE FREIN SYST. PERROT/WABCO	BRAKE KIT PERROT SYS.
MCxxxx	MAITRE CYLINDRE	MASTER CYLINDER
MFxxxx	MACHOIRES DE FREIN	BRAKE SHOES
MPxxxx	MACHOIRES FREIN PARKING	HANDBRAKE SHOES
MPxxxxSA	MACHOIRES FREIN PARKING SANS ACC.	HANDBRAKE SHOES WITHOUT FITTING KIT
PKxx.xxxx.xx	KIT FREIN PARKING	PARKING BRAKE KIT
TFxxxx	TAMBOUR DE FREIN	BRAKE DRUM

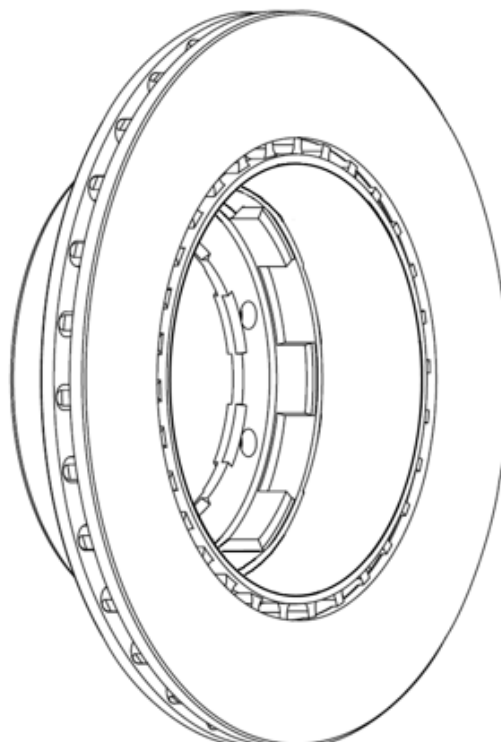
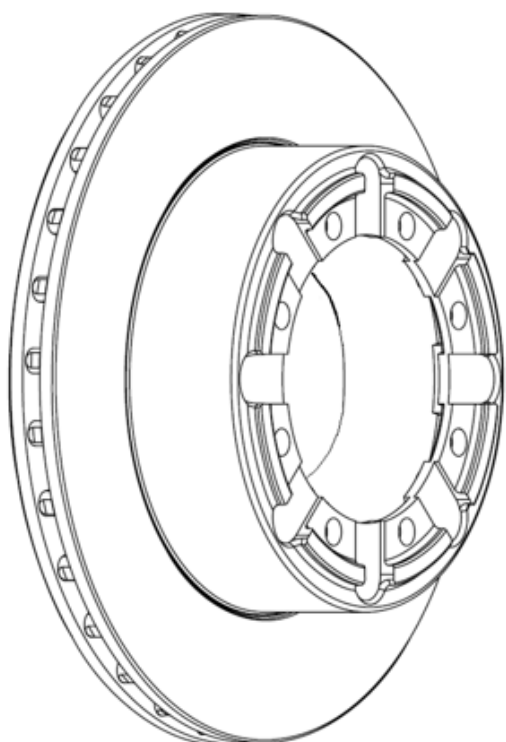
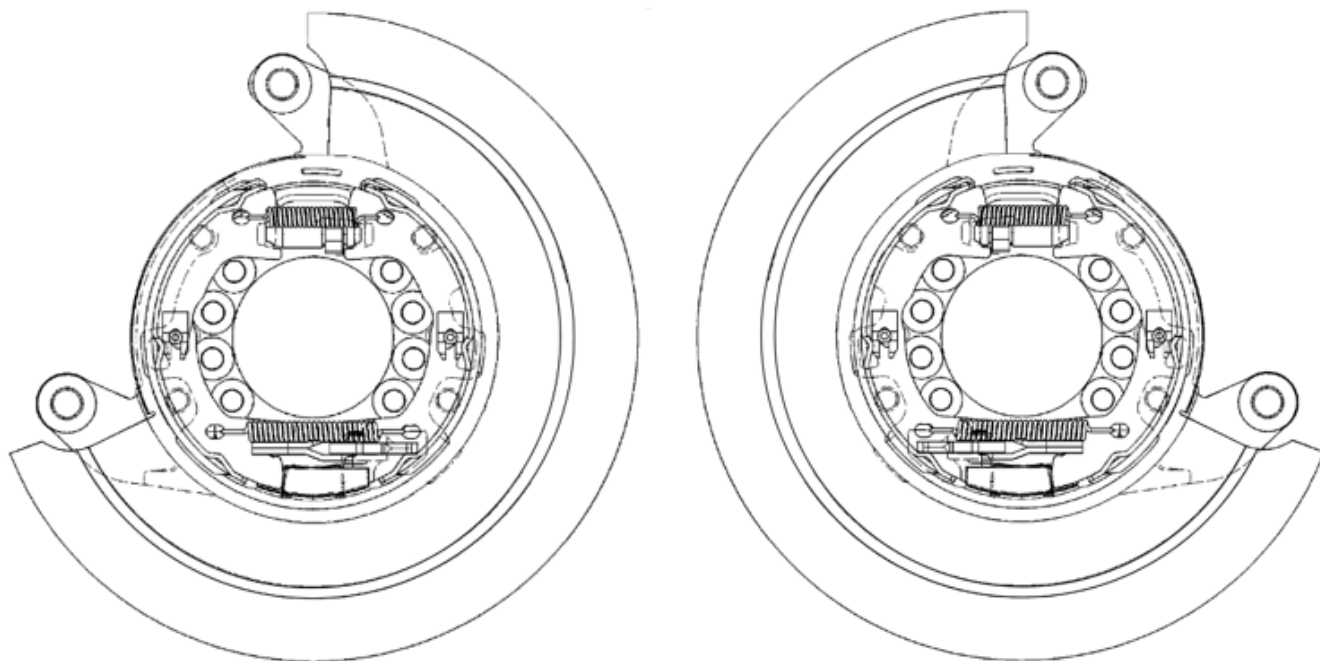
 Après ouverture du catalogue, veuillez taper les touches de votre clavier (**Ctrl+F**), une case va s'ouvrir (en vert) taper par exemple B90, appuyer sur entrée, vous remarquerez que vous arrivez sur les applications pour B90, appuyer sur entrée vous irez aux étriers pour le B90 et vous continuez cette procédure afin de trouver le restant des pièces pour le B90. Vous pouvez également effectuer une recherche d'un numéro OES exemple: Veuillez taper les touches de votre clavier (**Ctrl+F**), écrivez 42471111 puis entrée vous arriverez directement à la référence 08.5952.10 Après avoir trouvé la référence 08.5952.10, vous pouvez la copier en la sur brillant puis (**Ctrl+C**) et téléchargez le tarif général puis (**Ctrl+F**) et (**Ctrl+V**) pour coller, puis entrée, vous trouverez alors le prix et le code de remise du produit dans ce cas c'est VUL.

 After opening the catalog, please type the keys on your keyboard (**Ctrl + F**), a box will open (green) eg type B90, press enter, you will notice that you get the master cylinder B90, press on entry then go to the caliper application for B90 and you continue this process to find the remaining parts for B90. You can also search an OES number example: Please type in your keyboard (**Ctrl + F**), then write 42471111 entry you arrive at the reference 08.5952.10 After finding the part number 08.5952.10, you can copy it on the brilliant and (**Ctrl + C**) and then download list price (**Ctrl + F**) and (**Ctrl + V**) to paste and input, you then find the price and the product discount code in this case is VUL (LCV).

HBK2001

RENAULT MASTER II Propulsion 01.99-02.10 AR BREMBO PF 2.44

RENAULT TRUCKS MASCOTT 3,5 > 5,0 t. pont 569 01.99-12.07 AR BREMBO PF 2.44

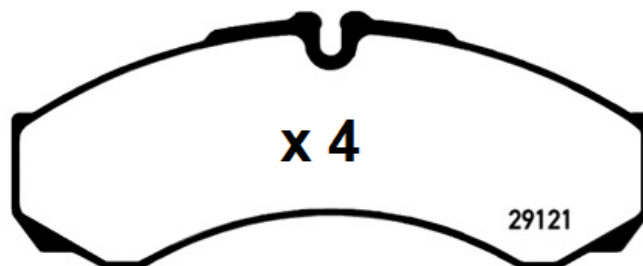
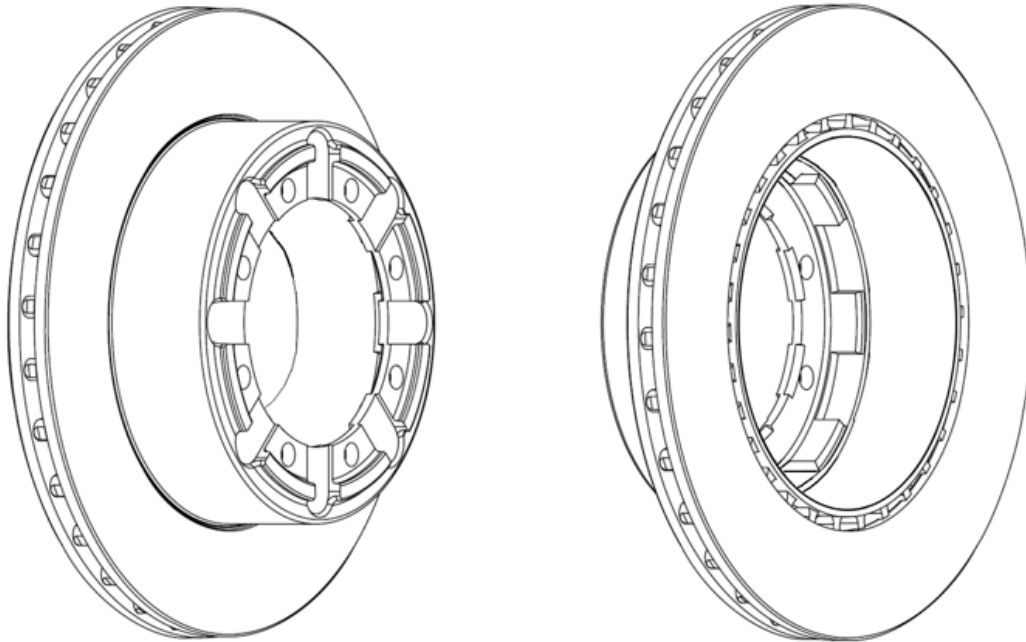
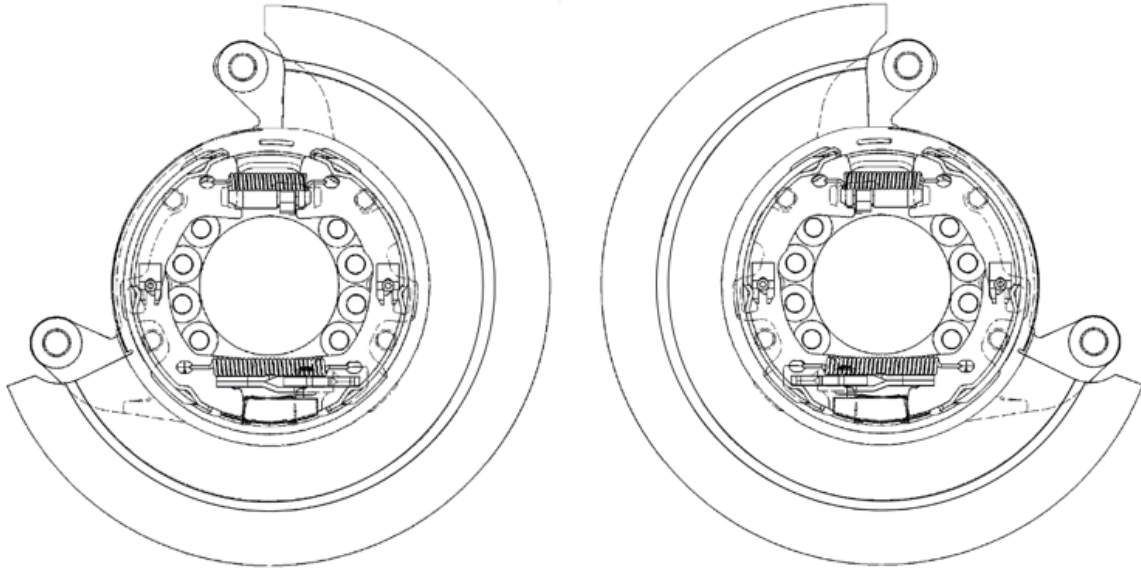


x32

HBK2001+

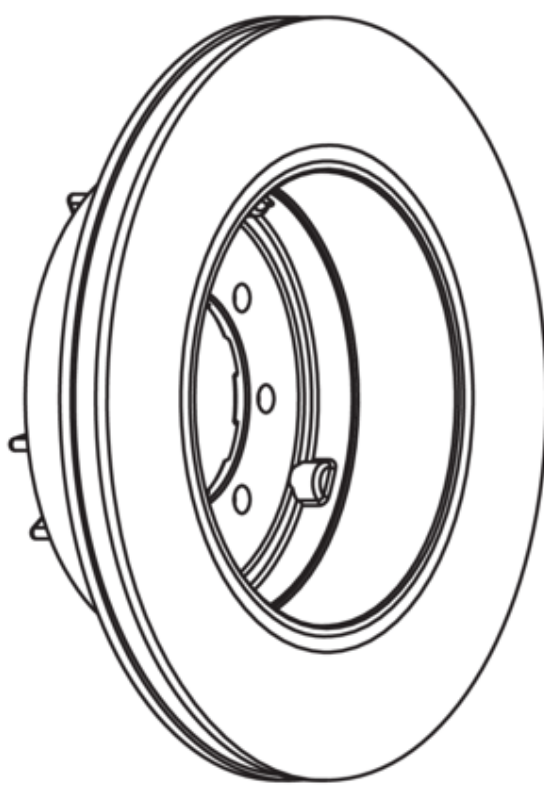
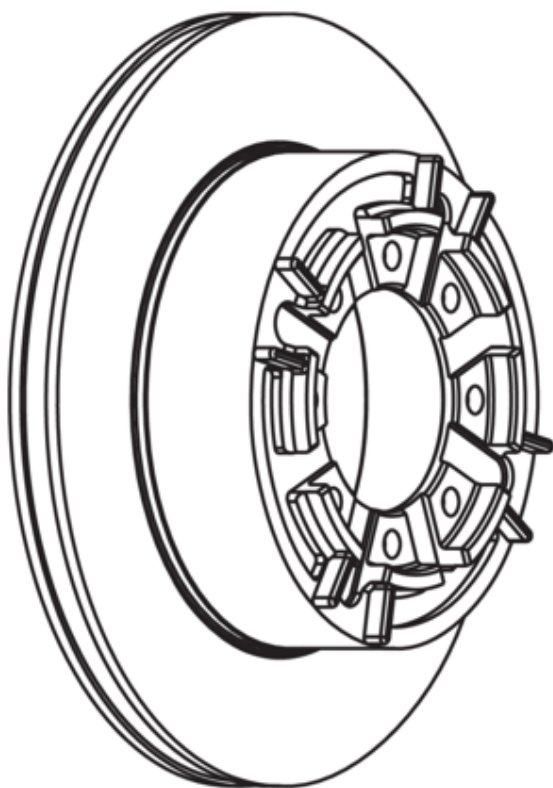
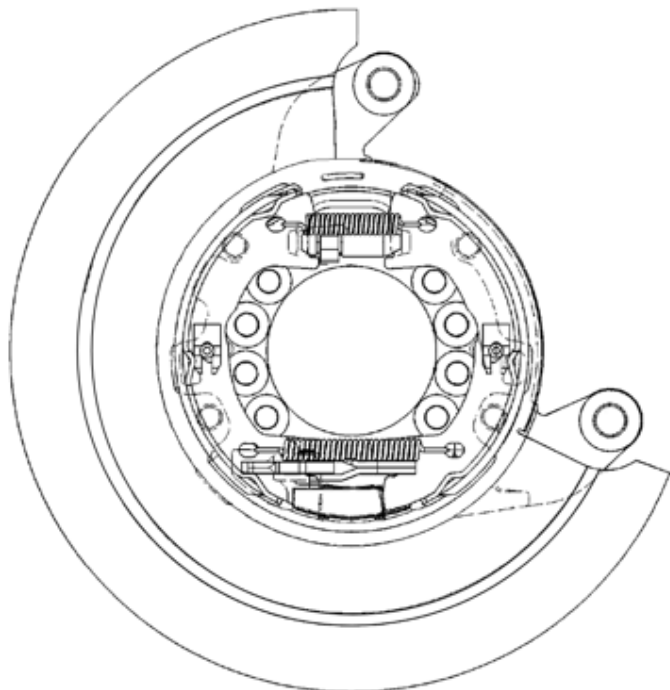
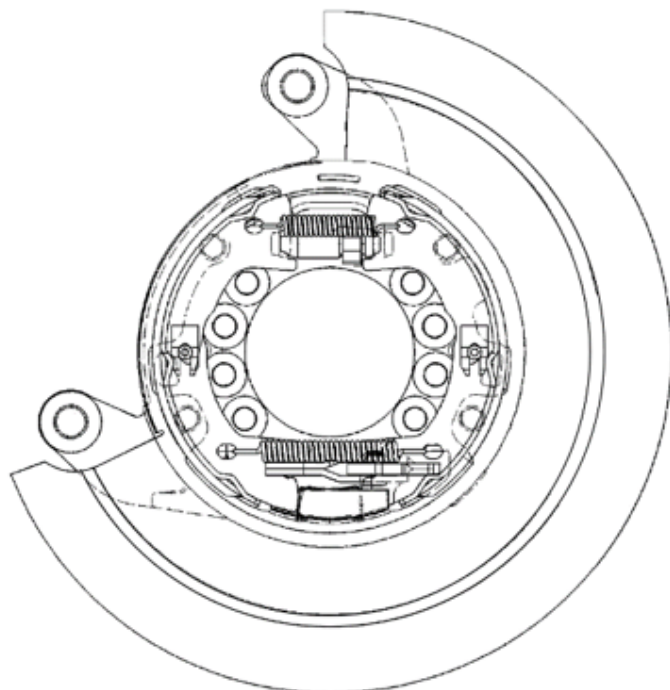
RENAULT MASTER II Propulsion 01.99-02.10 AR BREMBO PF 2.44

RENAULT TRUCKS MASCOTT 3,5 > 5,0 t. pont 569 01.99-12.07 AR BREMBO PF 2.44



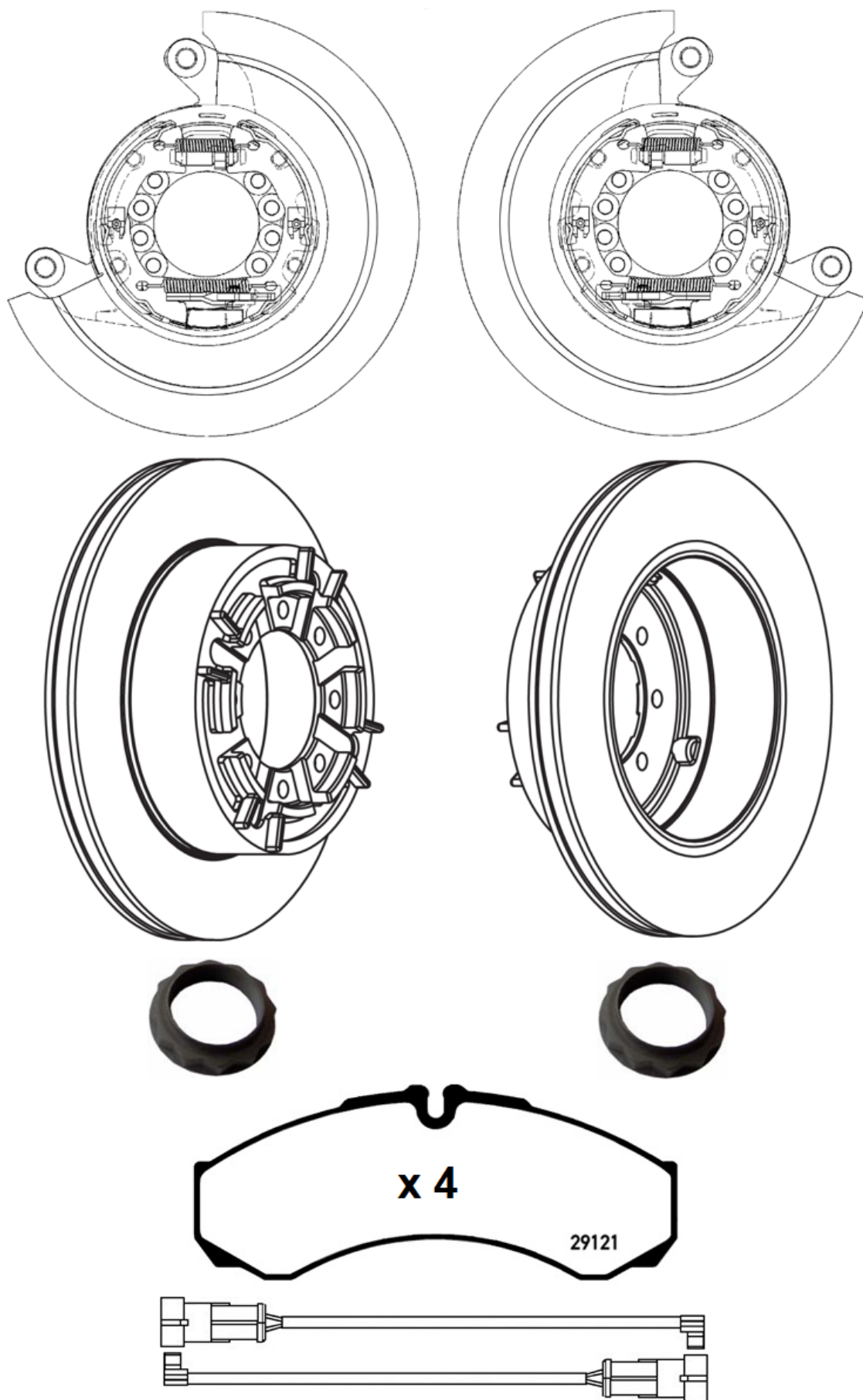
HBK2002

IVECO DAILY Série C 01.96-06.06 AR BREMBO PF 2.44

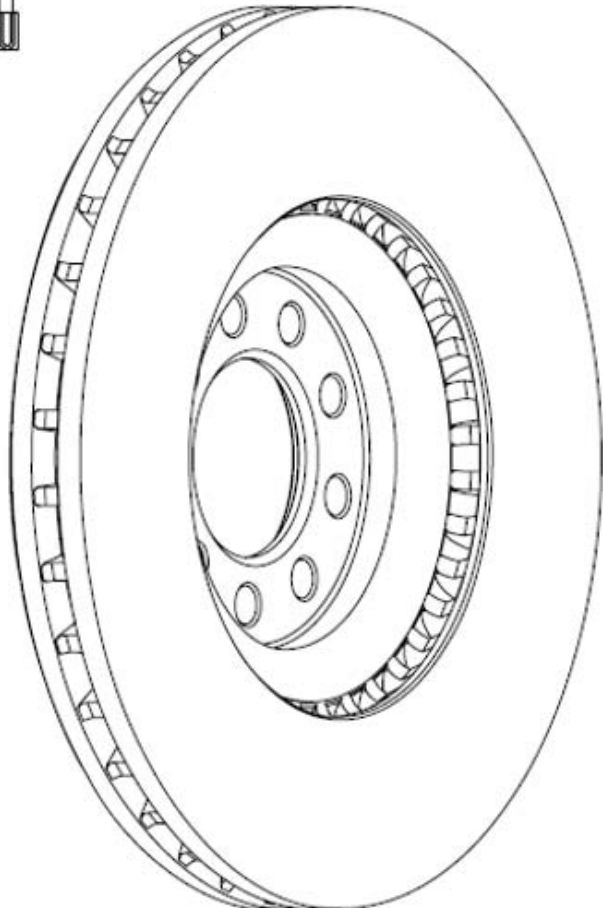
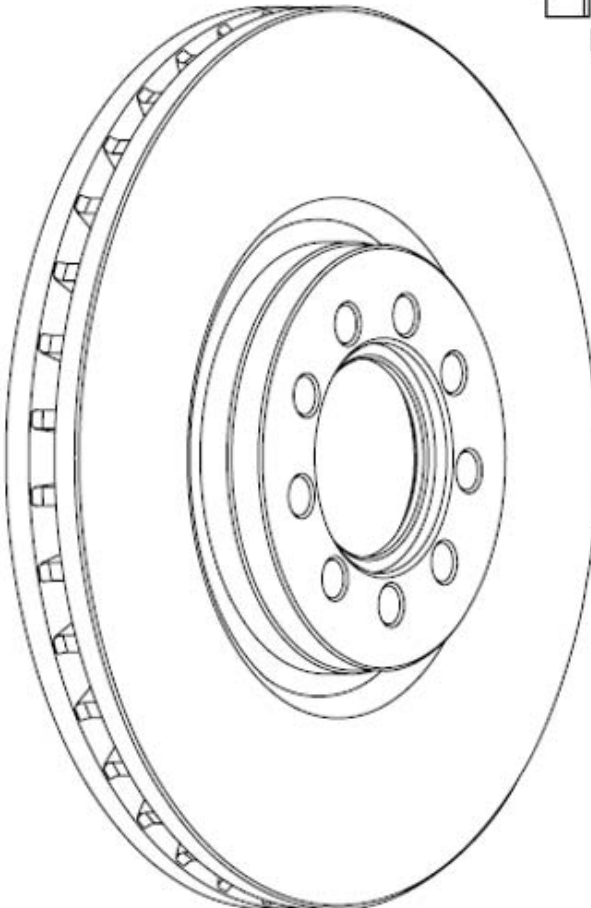
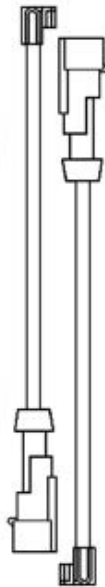


HBK2002+

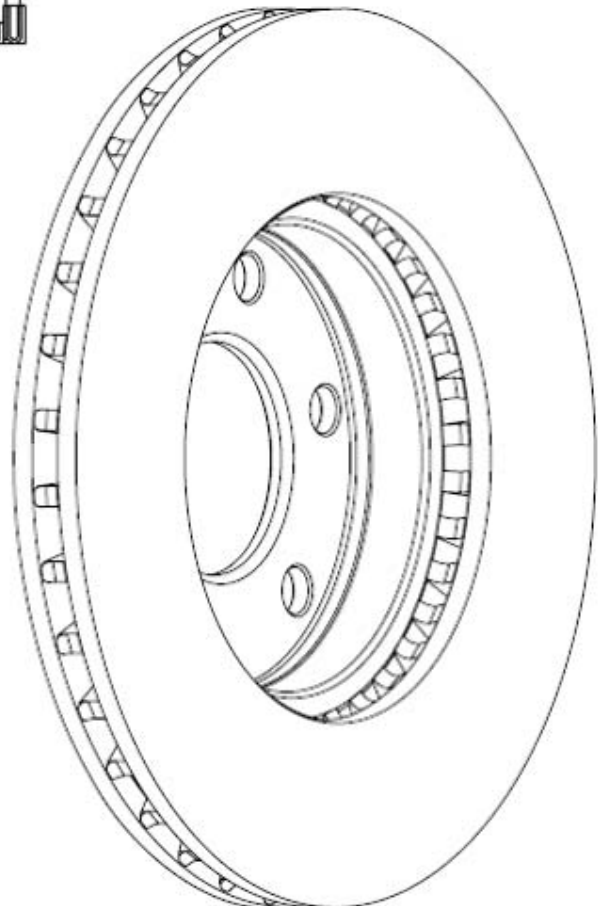
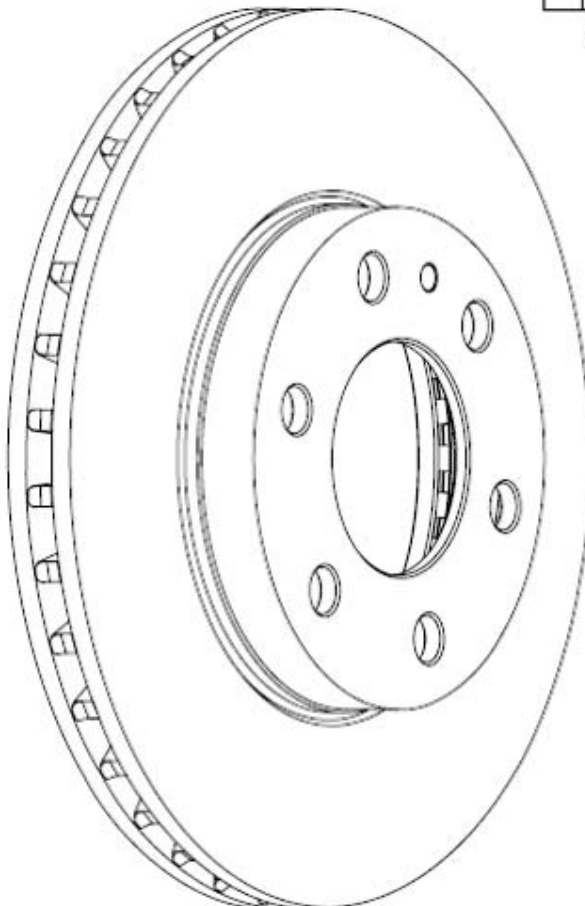
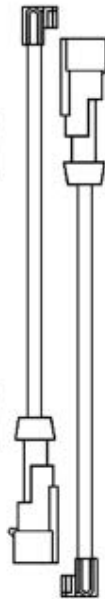
IVECO DAILY Série C 01.96-06.06 AR BREMBO PF 2.44



IVECO DAILY SERIE C 06.06- AV BREMBO PF 2.48



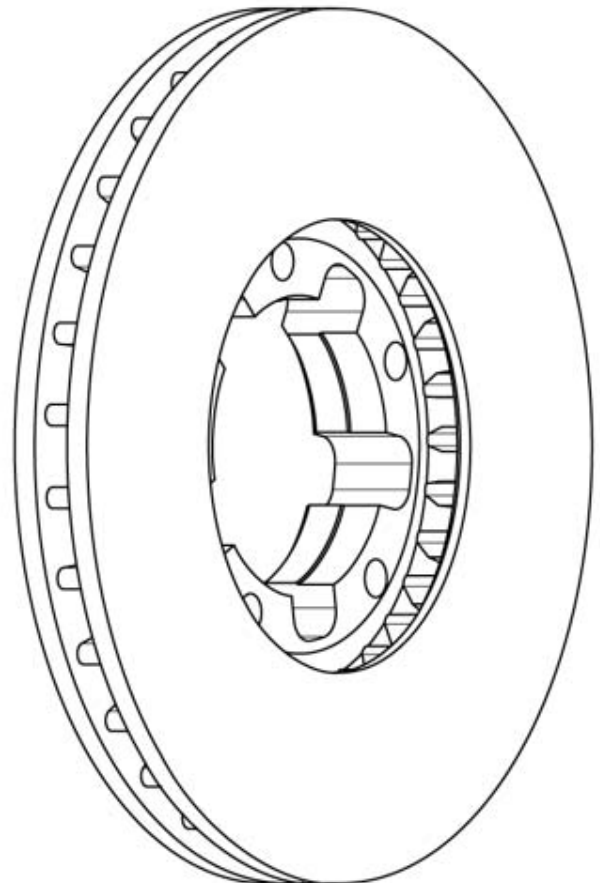
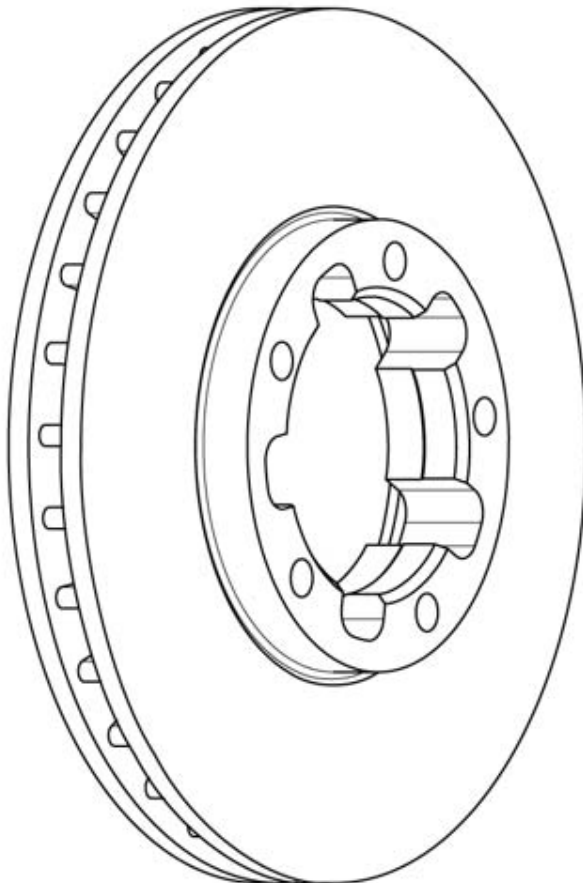
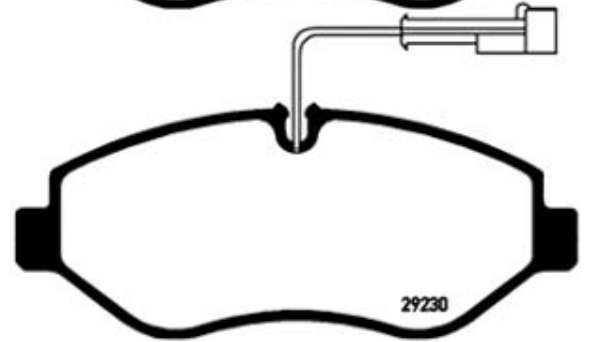
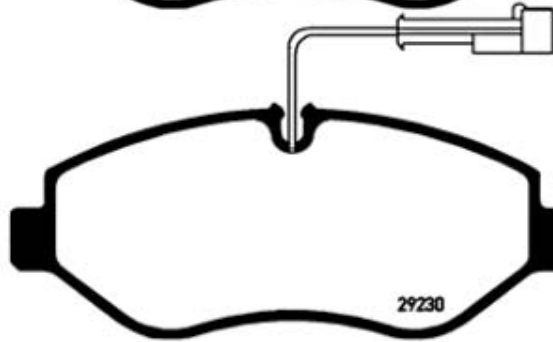
IVECO DAILY SERIE L & S 06.06- AV BREMBO PF 2.48



KDC1002

NISSAN CABSTAR 28 & 32 & 35 10.06- AV BREMBO PF 2.48

RENAULT TRUCKS MAXITY 28 & 32 & 35 10.07- AV BREMBO PF 2.48

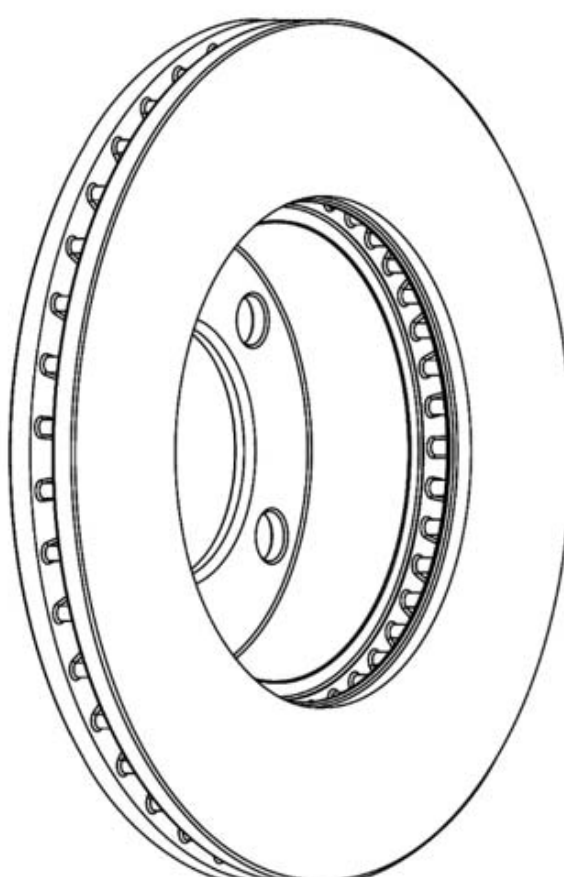
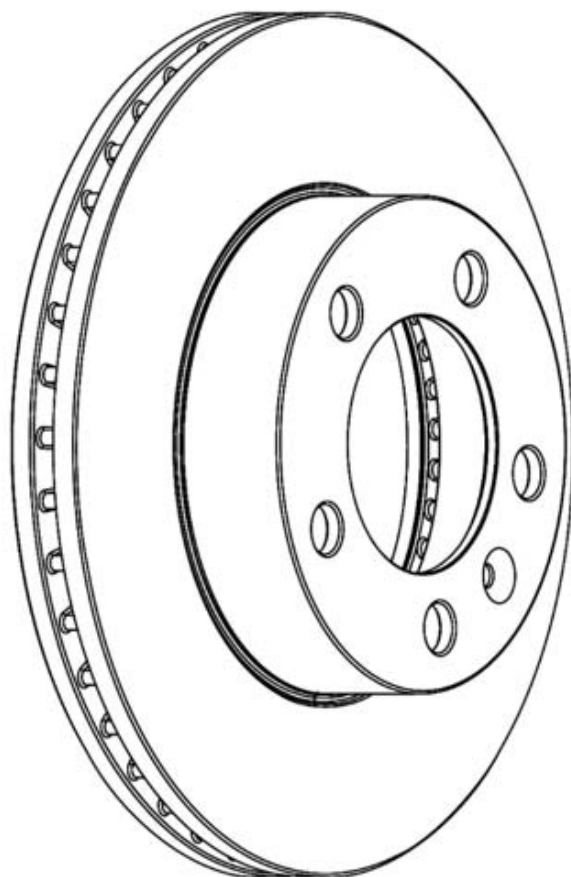
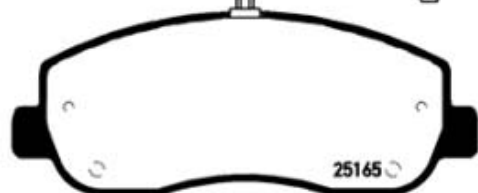
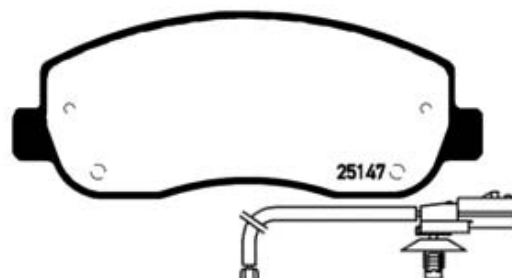
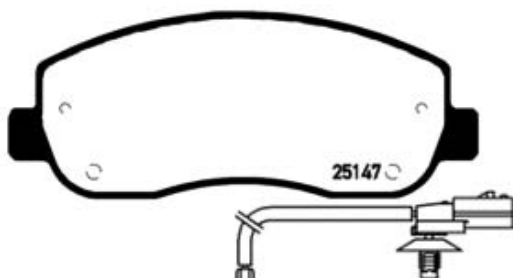


KDC1003

NISSAN NV400 2,3 dCi 11.11- AV BREMBO PF 2.48

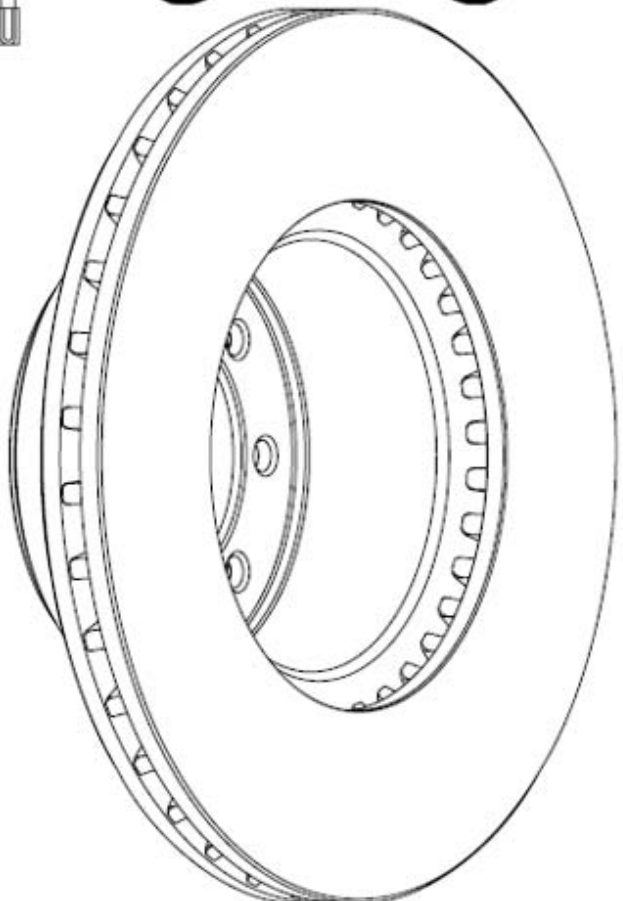
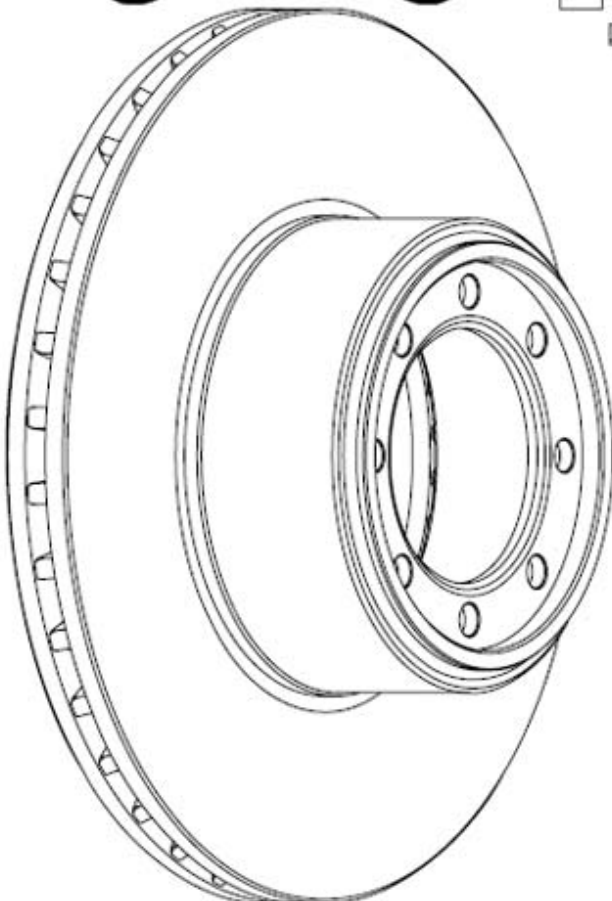
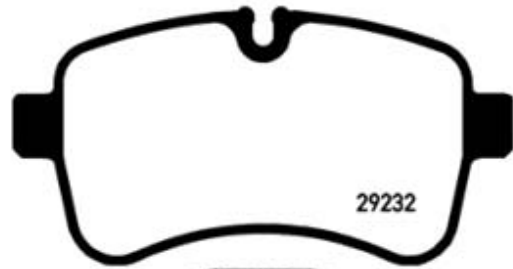
OPEL MOVANO B 2,3 CDTI 05.10- AV BREMBO PF 2.48

RENAULT MASTER III 2,3 dCi 02.10- AV BREMBO PF 2.48



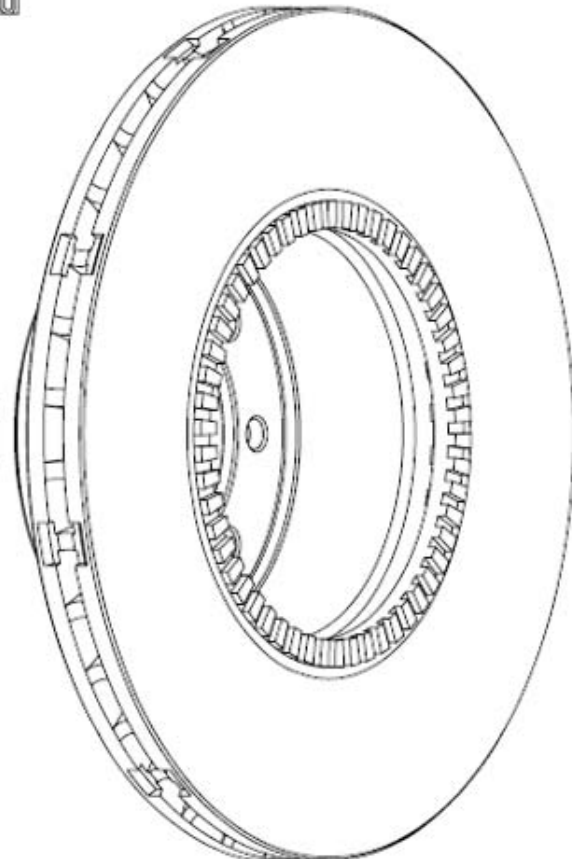
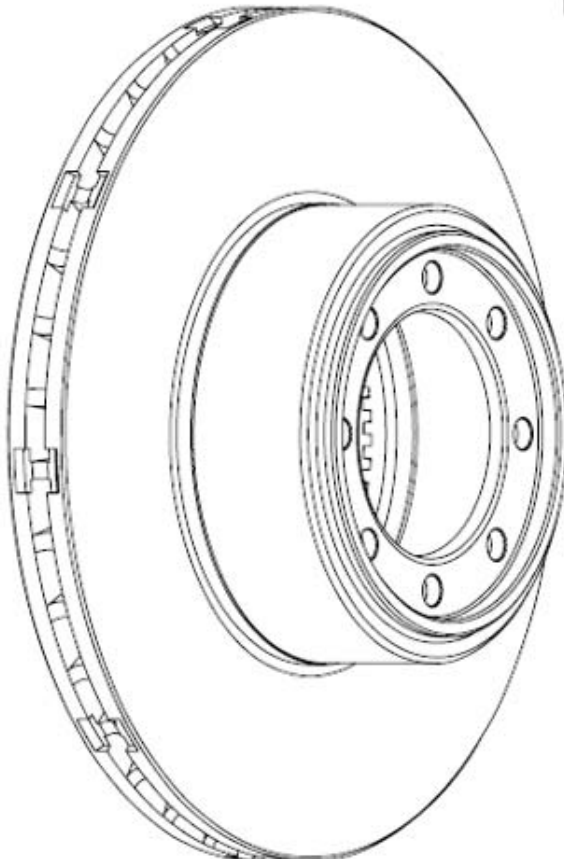
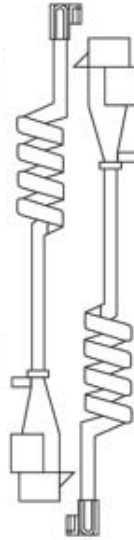
KDC3000

IVECO DAILY SERIE C (DISC ABS-) 06.06- AR BREMBO PFC 1.60



KDC3001

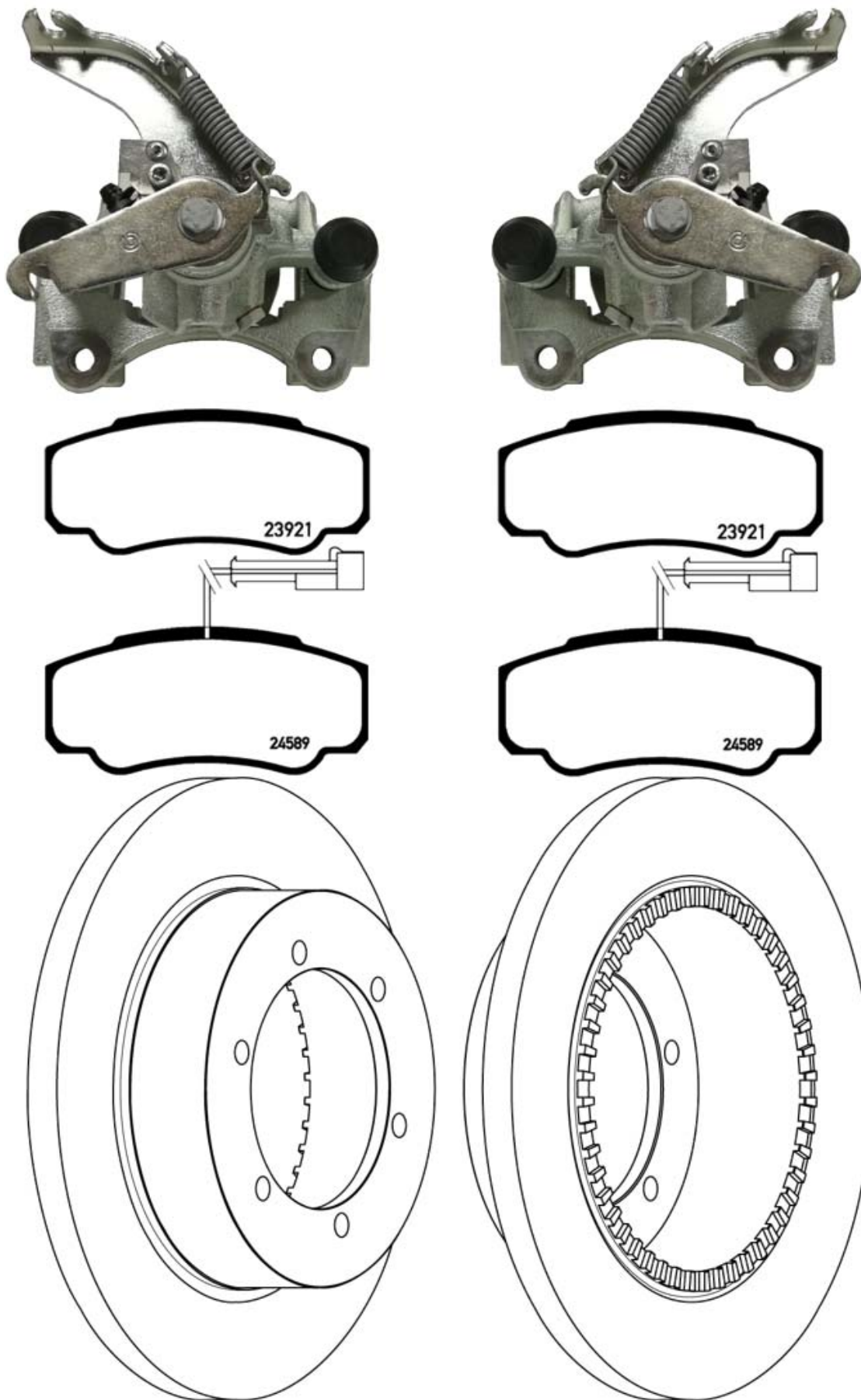
IVECO DAILY SERIE C (DISC ABS+) 06.06- AR BREMBO PFC 1.60



KDC3002

NISSAN CABSTAR 28 & 32 & 35 (DISC ABS+) 10.06- AR BREMBO PFC 1.46

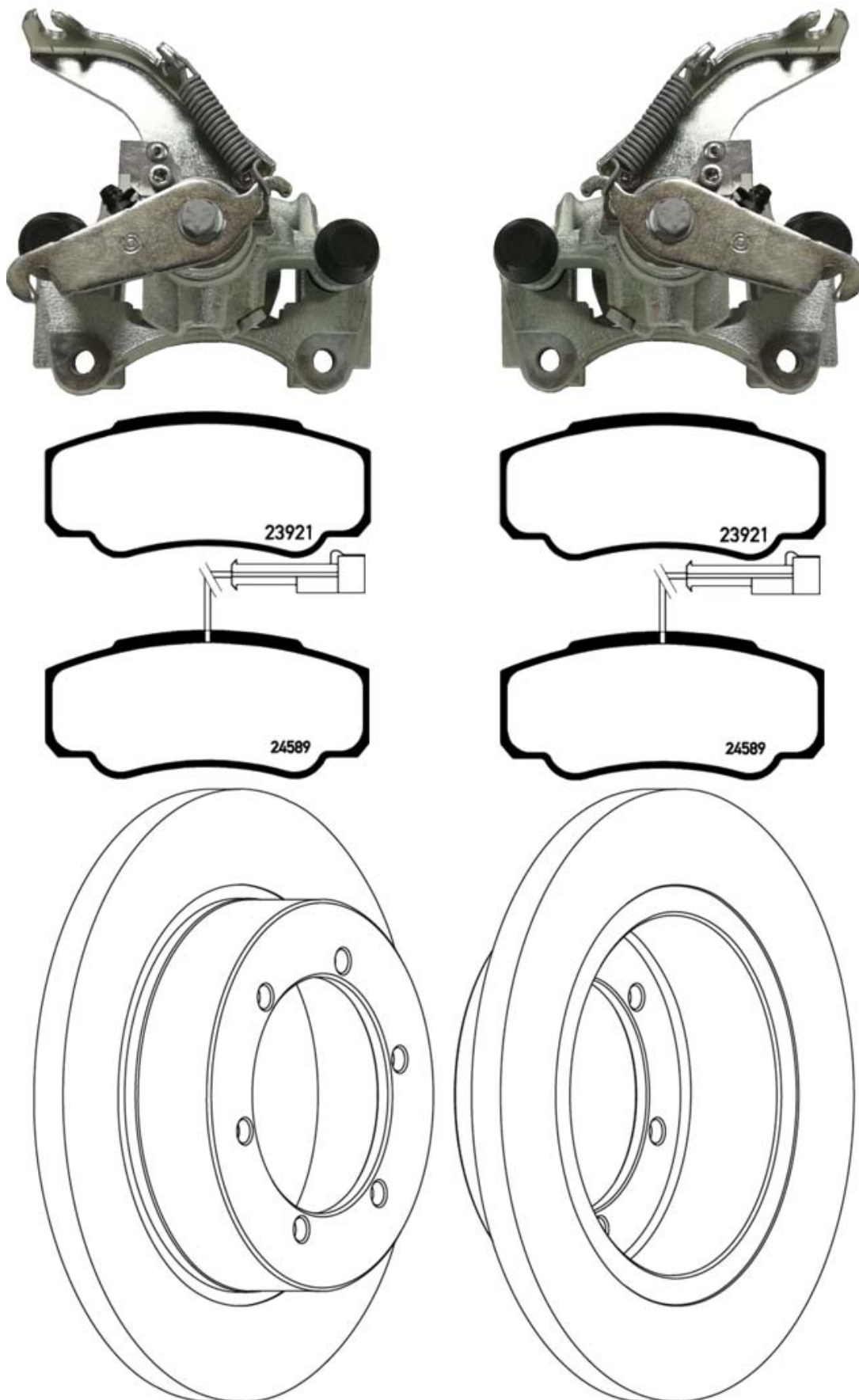
RENAULT TRUCKS MAXITY 28 & 32 & 35 (DISC ABS+) 10.07- AR BREMBO PFC 1.46



KDC3003

NISSAN CABSTAR 28 & 32 & 35 (DISC ABS-) 10.06- AR BREMBO PFC 1.46

RENAULT TRUCKS MAXITY 28 & 32 & 35 (DISC ABS-) 10.07- AR BREMBO PFC 1.46

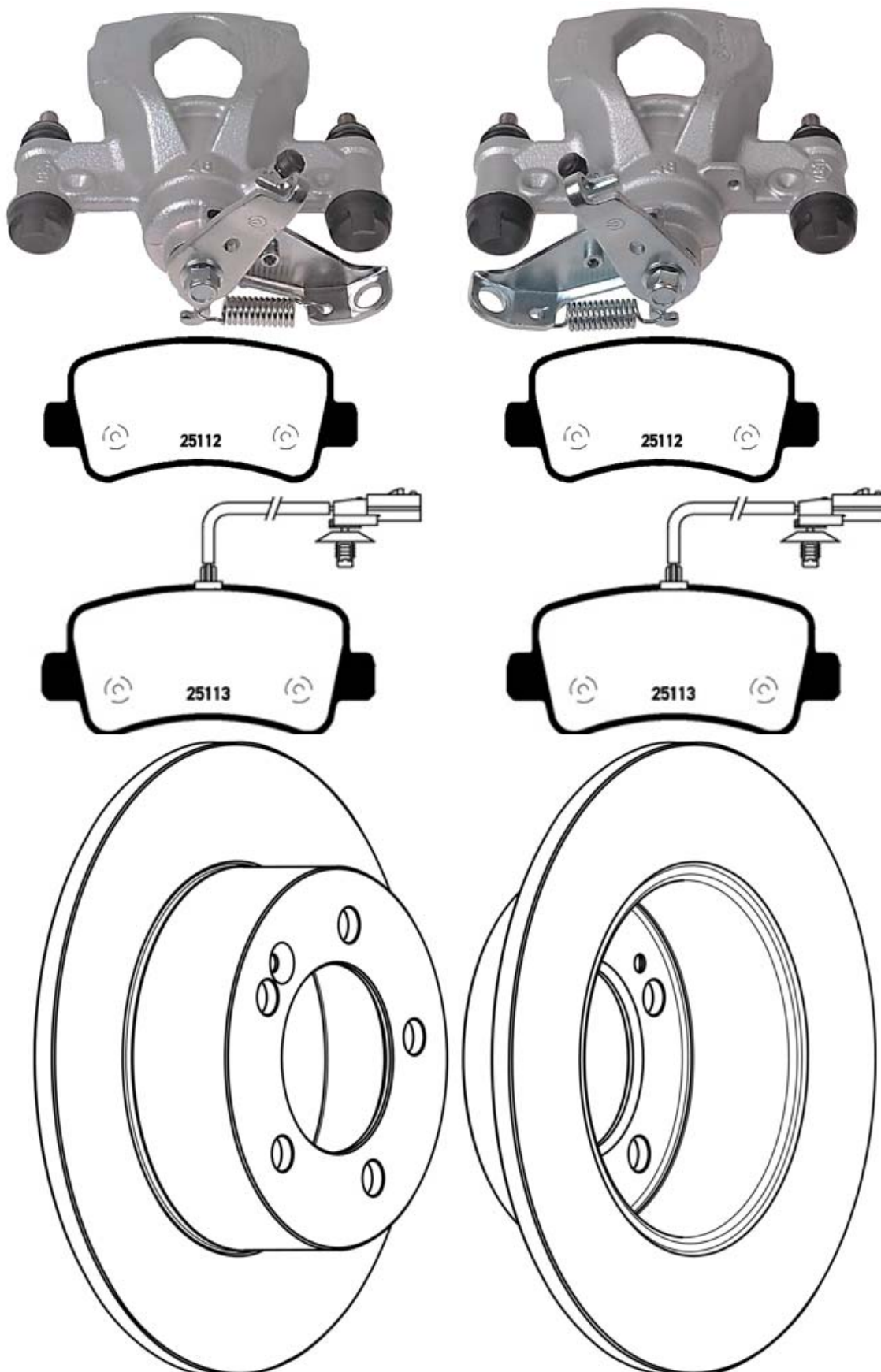


KDC3004

NISSAN NV400 2,3 dCi Roue simple (RWD-PROPULSION) 11.11- AR BREMBO PFC 1.48

OPEL MOVANO B 2,3 CDTI Roue simple (RWD-PROPULSION) 05.10- AR BREMBO PFC 1.48

RENAULT MASTER III 2,3 dCi Roue simple (RWD-PROPULSION) 02.10- AR BREMBO PFC 1.48

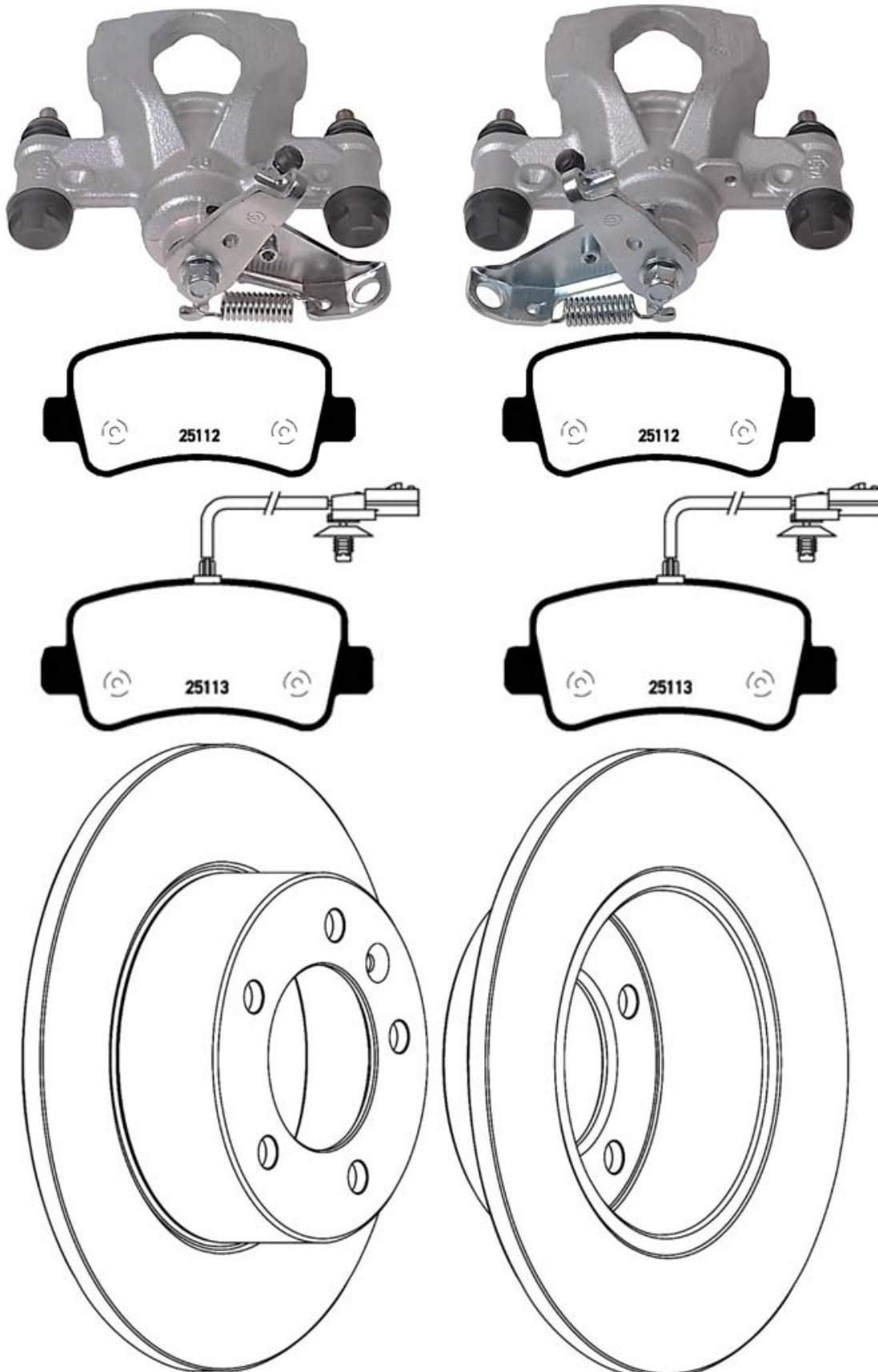


KDC3005

NISSAN NV400 2,3 dCi Roue simple (FWD-TRACTION) 11.11- AR BREMBO PFC 1.48

OPEL MOVANO B 2,3 CDTI Roue simple (FWD-TRACTION) 05.10- AR BREMBO PFC 1.48

RENAULT MASTER III 2,3 dCi Roue simple (FWD-TRACTION) 02.10- AR BREMBO PFC 1.48

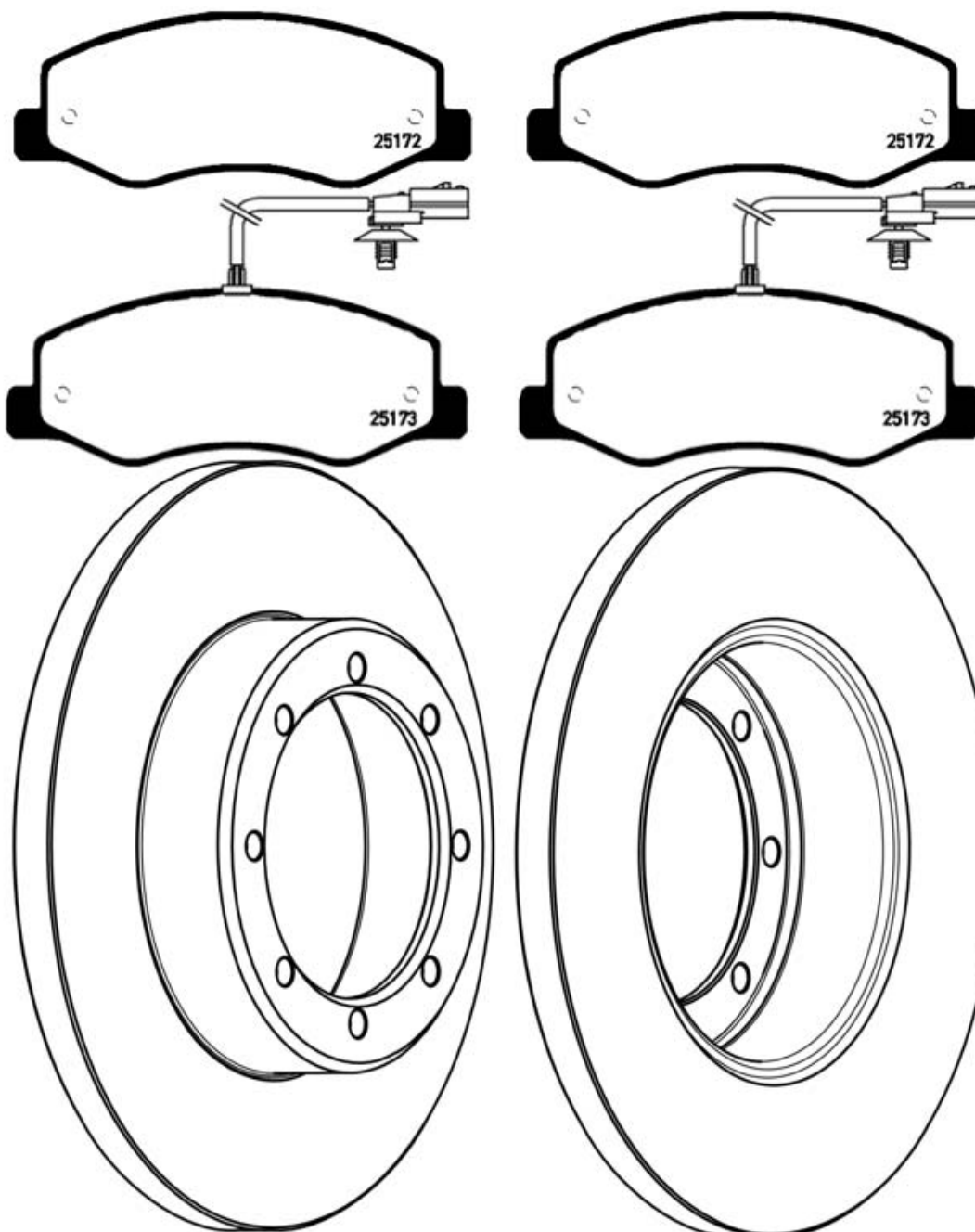


KDC3006

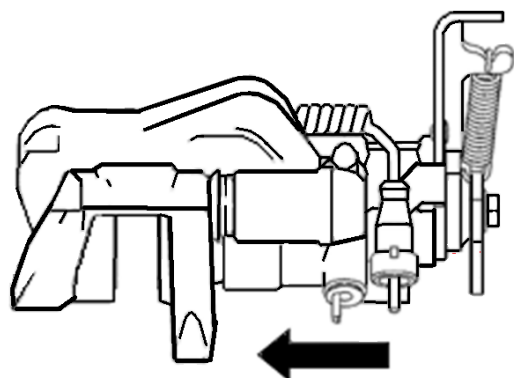
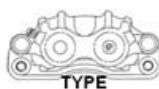
NISSAN NV400 2,3 dCi Roue jumelée 11.11- AR BREMBO PFC 1.60

OPEL MOVANO B 2,3 CDTI Roue jumelée 05.10- AR BREMBO PFC 1.60

RENAULT MASTER III 2,3 dCi Roue jumelée 02.10- AR BREMBO PFC 1.60



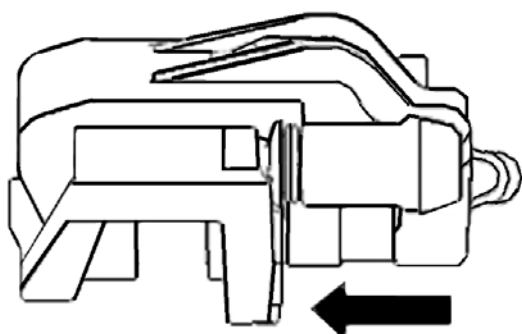
CLASSIFICATION ETRIER DE FREIN BRAKE CALIPER CLASSIFICATION



PFC

Pince ou étrier flottant avec commande de frein de parking; à l'arrière du véhicule; La plupart des véhicules récents sont équipées avec ce système.

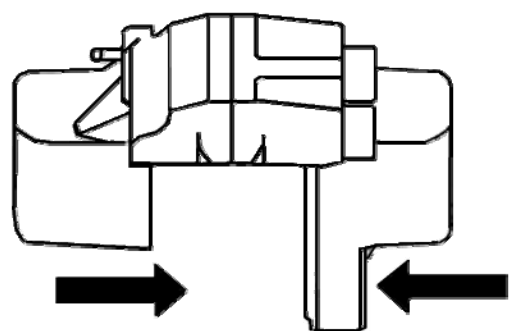
Floating brake caliper with parking brake control in the rear of the vehicle; used in most recent LCV.



PF

Pince ou étrier flottant; principalement à l'avant du véhicule; à l'arrière le disque reçoit un système de frein à main à l'intérieur, D.I.H Drum in hat : tambour dans le chapeau.

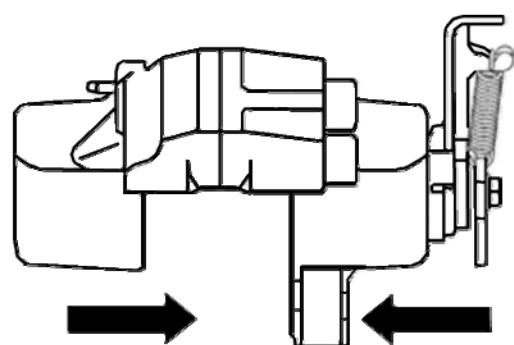
Floating brake caliper, used mainly in front of the vehicle, rear brake disc system is equipped with a parking brake inside, D.I.H. Drum in hat.



P

Pince ou étrier fixe; principalement à l'avant du véhicule sur les anciens véhicules; à l'arrière les véhicules sont équipés de frein à tambours.

Fixed brake caliper; used mainly in the front of older models, the vehicles are equipped with rear brake drums.

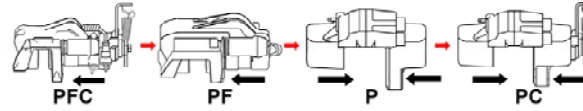














PC

Pince ou étrier fixe avec commande de frein de parking; à l'arrière du véhicule; Montage rarissime: dans le catalogue vous le trouverez pour l'équipement d'un Mercedes Unimog.

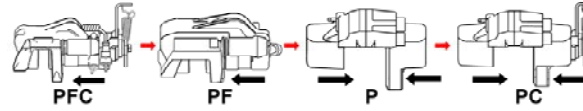
Fixed brake caliper with parking brake control in the rear of the vehicle; mounting rarely used. In the catalog you will find this equipment on a Mercedes Unimog.













CLASSIFICATION ETRIER DE FREIN PAR TYPE
BRAKE CALIPERS CLASSIFICATION BY TYPE



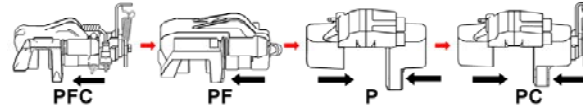
 TYPE			REF G/L	N° fonderie/ Casting		REF D/R	N° fonderie/ Casting
TRW/LUCAS PFC 1.41	NISSAN, OPEL, RENAULT		EFR017	837013; 61707; N300		EFR018	N300
TRW/LUCAS PFC 1.41	OPEL RENAULT TRAFIC		EFR164	61707		EFR165	61707
TRW/LUCAS PFC 1.41	VW TRANSPORTER T5		EFR168	8291-1		EFR169	8291-2
BOSCH PFC 1.42	NISSAN, OPEL, RENAULT		EFR013	0204; Y01158; 2879L		EFR014	0204; Y01159; 3074R



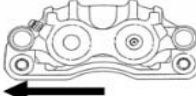









CLASSIFICATION ETRIER DE FREIN PAR TYPE
BRAKE CALIPERS CLASSIFICATION BY TYPE



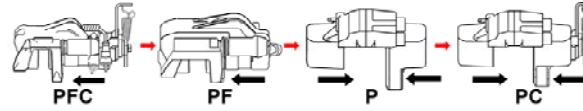
 TYPE			REF G/L	N° fonderie/ Casting		REF D/R	N° fonderie/ Casting
BREMBO PFC 1.46	NISSAN, RENAULT TRUCKS (avec support/ with carrier)		522.9715.75	971400; 815502		522.9715.85	971400; 815502
BREMBO PFC 1.48	NISSAN, OPEL, RENAULT, RENAULT TRUCKS		EFR089	8200735275; A49700		EFR090	8200735277; A49701
BREMBO PFC 1.52	IVECO DAILY (avec support/ with carrier)		522.7270.52	727137; 727206; 22727017		522.7270.62	727137; 727206; 22727027
BREMBO PFC 1.60	IVECO DAILY (avec support/ with carrier)		522.9721.00	8129; 972206; 972301		522.9721.01	8129; 972205; 972301



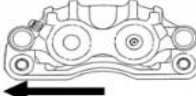
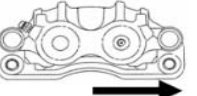








CLASSIFICATION ETRIER DE FREIN PAR TYPE
BRAKE CALIPERS CLASSIFICATION BY TYPE



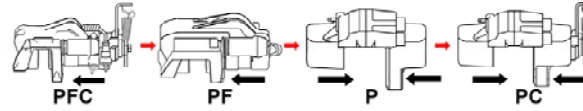
 TYPE			REF G/L	N° fonderie/ Casting		REF D/R	N° fonderie/ Casting
BREMBO PFC 1.60	NISSAN, OPEL, RENAULT, RENAULT TRUCKS		EFR091	440107583R; A51730		EFR092	440107584R; A51731
MERITOR PFC 2.54	MERCEDES SPRINTER (avec support/ with carrier)		EFR108	68322795; 68320760; 31320083		EFR109	68322796; 68320760; 31320083
MERITOR PFC 2.58	FORD, IVECO (avec support/ with carrier)		EFR144	68320175; 68320190; 68320197		EFR145	68320176; 68320190; 68320197
MERITOR PFC 2.58	VOLVO (avec support/ with carrier)		EFR027	68320068; 68320195; 68320197		EFR028	68320069; 68320195; 68320197









CLASSIFICATION ETRIER DE FREIN PAR TYPE
BRAKE CALIPERS CLASSIFICATION BY TYPE



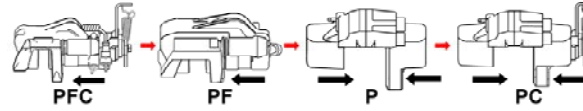
 TYPE			REF G/L	N° fonderie/ Casting		REF D/R	N° fonderie/ Casting
BREMBO PFC 2.60	IVECO EUROCARGO 60 (avec support/ with carrier)		522.5770.16	576201; 577102 576301; 22577017		522.5770.26	576201; 577102 576301; 22577027
BREMBO PFC 2.60	IVECO EUROCARGO 70 (avec support/ with carrier)		522.9801.08	980806; 881301; 981201; 22980106		522.9801.09	980806; 881301; 981201; 22980107
MERITOR PFC 2.60	MERCEDES VARIO (avec support/ with carrier)		EFR031	68321752; 68320760; 31320083		EFR032	68321751; 31320096; 31320083
MERITOR PFC 2.60	MERCEDES VARIO (avec support/ with carrier)		EFR033	68321751; 68320760; 31320083		EFR034	68321752; 68320760; 31320083













CLASSIFICATION ETRIER DE FREIN PAR TYPE
BRAKE CALIPERS CLASSIFICATION BY TYPE



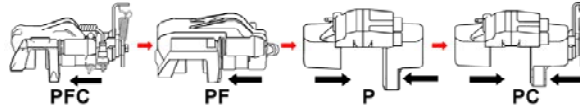
 TYPE			REF G/L	N° fonderie/ Casting		REF D/R	N° fonderie/ Casting
MERITOR PFC 2.60	IVECO FORD (avec support/ with carrier)		EFR134	68320315; 68320760; 68320192		EFR135	68320316; 68320760; 68320192
BREMBO PFC 2.68	IVECO EUROCARGO 80 (avec support/ with carrier)		522.5670.08	566301; 566202; 22567014		522.5670.09	566301; 566202; 22567024
BREMBO PFC 2.68	IVECO EUROCARGO 100 (avec support/ with carrier)		522.9803.08	980106; 881301; 981201; 22980306		522.9803.09	980106; 881301; 981201; 22980307
MERITOR PFC 2.68	IVECO EUROCARGO (avec support/ with carrier)		EFR158	68320313; 68320190; 68320197		EFR159	68320314; 68320190; 68320197

**CLASSIFICATION ETRIER DE FREIN PAR TYPE
BRAKE CALIPERS CLASSIFICATION BY TYPE**



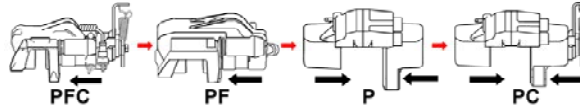
 TYPE			REF G/L	N° fonderie/ Casting		REF D/R	N° fonderie/ Casting
MERITOR PFC 2.68	NISSAN ATLEON (avec support/ with carrier)		EFR100	68320173; 68320190; 68320197		EFR101	68320174; 68320190; 68320197
MERITOR PFC 2.68	VOLVO FL SERIE (avec support/ with carrier)		EFR029	68320019; 68320195; 68320197		EFR030	68320020; 68320195; 68320197
ATE/TEVES PF 1.45	MERCEDES VW		EFR174			EFR175	
BREMBO PF 1.46	CITROËN JUMPER, FIAT DUCATO, PEUGEOT BOXER (avec support/ with carrier) (ABS-)		522.8153.12	815401		522.8153.22	815401













CLASSIFICATION ETRIER DE FREIN PAR TYPE
BRAKE CALIPERS CLASSIFICATION BY TYPE



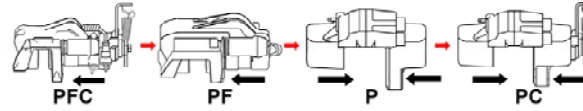
 TYPE			REF G/L	N° fonderie/ Casting		REF D/R	N° fonderie/ Casting
SUMITOMO PF 1.48	MITSUBISHI CANTER (SUP) + guide		EFR069	FX14C		EFR070	FX14C
SUMITOMO PF 1.48	MITSUBISHI CANTER (INF) + guide		EFR071	FX14C		EFR072	FX14C
BOSCH PF 1.51	MERCEDES SPRINTER, VOLKSWAGEN CRAFTER		EFR073	Y04125		EFR074	Y04127
ATE/TEVES PF 1.52	MERCEDES VW		EFR170			EFR171	

















CLASSIFICATION ETRIER DE FREIN PAR TYPE
BRAKE CALIPERS CLASSIFICATION BY TYPE



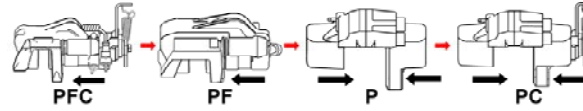
 TYPE			REF G/L	N° fonderie/ Casting		REF D/R	N° fonderie/ Casting
SUMITOMO PF 1.54	MITSUBISHI CANTER (SUP) + guide		EFR176	FX15C		EFR177	FX15C
SUMITOMO PF 1.54	MITSUBISHI CANTER (INF) + guide		EFR178	FX15C		EFR179	FX15C
SUMITOMO PF 1.68	MITSUBISHI CANTER		EFR120			EFR121	
GIRLING PF 2.38/48	CITROEN C25, FIAT DUCATO, PEUGEOT J5		EFR148			EFR149	















CLASSIFICATION ETRIER DE FREIN PAR TYPE
BRAKE CALIPERS CLASSIFICATION BY TYPE



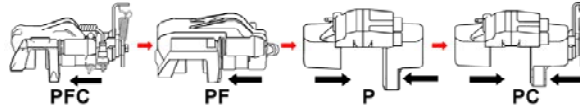
TYPE	VUL		REF G/L	N° fonderie/ Casting		REF D/R	N° fonderie/ Casting
TRW/LUCAS PF 2.40/45	NISSAN PRIMASTAR, OPEL VIVARO, RENAULT TRAFIC		EFR015	440678; 54925; 7636/B; CN3		EFR016	003507; 65922; 7637/1; CN3
BREMBO PF 2.42	IVECO DAILY Série S (avec support/ with carrier)		522.7220.01	722102; 594202; 22722003		522.7220.02	722102; 594202; 22722004
BREMBO PF 2.44	IVECO DAILY C (avec support/ with carrier)		522.7773.28	777434; 594205		522.7773.29	777434; 594205
BREMBO PF 2.44	RENAULT MASTER, RT MASCOTT (avec support/ with carrier)		522.7773.73			522.7773.83	
BREMBO PF 2.44	IVECO DAILY, NISSAN CABSTAR NT500, RT MAXITY (avec support/ with carrier)		522.7775.28	777652; 594205		522.7775.29	777652; 594205
BREMBO PF 2.44	RENAULT MASTER, RT MASCOTT (avec support/ with carrier)		522.7775.73	777652; 594205		522.7775.83	777652; 594205
BREMBO PF 2.44	IVECO DAILY S (avec support/ with carrier)		522.9272.01	927300; 591205		522.9272.02	927300; 591205



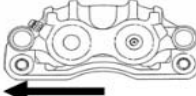











CLASSIFICATION ETRIER DE FREIN PAR TYPE
BRAKE CALIPERS CLASSIFICATION BY TYPE



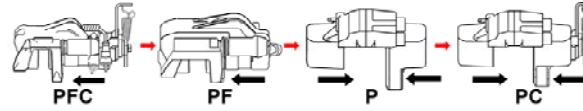
 TYPE			REF G/L	N° fonderie/ Casting		REF D/R	N° fonderie/ Casting
PERROT PF 2.44	MERCEDES SPRINTER VARIO, VOLKSWAGEN LT (V1)		EFR051	318CN1; 050B138		EFR052	318CN1; 0519202
PERROT PF 2.44	MERCEDES SPRINTER VARIO, VOLKSWAGEN LT (V2)		EFR128			EFR129	
BREMBO PF 2.44/48	CITROËN JUMPER, FIAT DUCATO, PEUGEOT BOXER (ABS-)		522.8142.45	814301		522.8142.55	814301
BREMBO PF 2.44/48	CITROËN JUMPER, FIAT DUCATO, PEUGEOT BOXER (ABS+)		522.8142.46	814306		522.8142.56	814306
BENDIX PF 2.45	RENAULT TRAFIC		EFR172	330447		EFR173	330448




CLASSIFICATION ETRIER DE FREIN PAR TYPE
BRAKE CALIPERS CLASSIFICATION BY TYPE



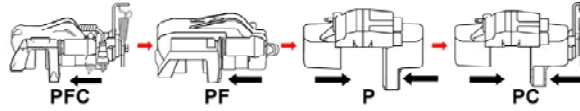
 TYPE			REF G/L	N° fonderie/ Casting		REF D/R	N° fonderie/ Casting
BOSCH PF 2.45	OPEL MOVANO, RENAULT MASTER		EFR007	209		EFR008	210
BOSCH PF 2.45	NISSAN INTERSTAR, OPEL MOVANO, RENAULT MASTER		EFR009			EFR010	
BOSCH PF 2.45	RENAULT MASTER		EFR011			EFR012	
BOSCH PF 2.45	MERCEDES SPRINTER, VOLKSWAGEN LT46 (V1)		EFR095			EFR096	
BOSCH PF 2.45	MERCEDES SPRINTER, VOLKSWAGEN LT46 (V2)		EFR126			EFR127	


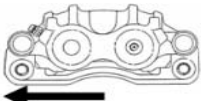
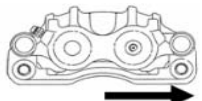







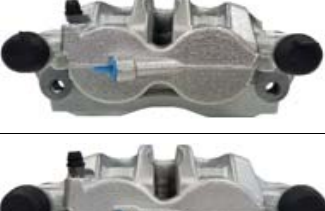
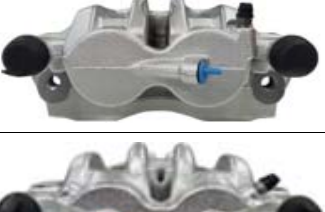



CLASSIFICATION ETRIER DE FREIN PAR TYPE
BRAKE CALIPERS CLASSIFICATION BY TYPE



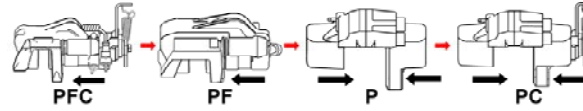
 TYPE			REF G/L	N° fonderie/ Casting		REF D/R	N° fonderie/ Casting
BREMBO PF 2.46	IVECO DAILY, RT MASCOTT (avec support/ with carrier)		522.7306.28	730708; 594205		522.7306.29	730708; 594205
BREMBO PF 2.46/52	CITROËN JUMPER, FIAT DUCATO, PEUGEOT BOXER (ABS-)		522.8148.45	815001		522.8148.55	815001
BREMBO PF 2.46/52	CITROËN JUMPER, FIAT DUCATO, PEUGEOT BOXER (ABS+)		522.8148.46	815006		522.8148.56	815006
BENDIX PF 2.48	PEUGEOT J7-J9		EFR098	431283		EFR099	431283
BENDIX PF 2.48	MERCEDES MB100 D		EFR067	216093		EFR068	216093















CLASSIFICATION ETRIER DE FREIN PAR TYPE
BRAKE CALIPERS CLASSIFICATION BY TYPE



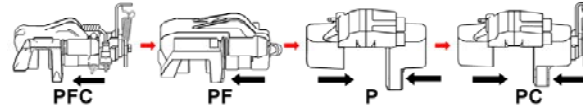
TYPE			REF G/L	N° fonderie/ Casting		REF D/R	N° fonderie/ Casting
BENDIX PF 2.48	NISSAN CABSTAR		EFR081	216174		EFR082	216174
BOSCH PF 2.48	MERCEDES SPRINTER, VOLKSWAGEN CRAFTER		EFR075	Y04133		EFR076	Y04134
BOSCH PF 2.48	NISSAN CABSTAR		EFR079			EFR080	
BREMBO PF 2.48	IVECO DAILY (avec support/ with carrier)		522.9700.10	970113; 970201		522.9700.20	970123; 970201
BREMBO PF 2.48	NISSAN CABSTAR, RT MAXITY (avec support/ with carrier)		522.9700.76	970108; 970201		522.9700.86	970108; 970201
BREMBO PF 2.48	IVECO DAILY (avec support/ with carrier)		522.9782.10	978301; 978400		522.9782.20	978301; 978400

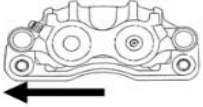
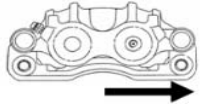












CLASSIFICATION ETRIER DE FREIN PAR TYPE
BRAKE CALIPERS CLASSIFICATION BY TYPE



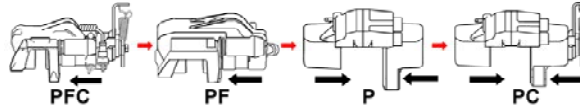
 TYPE	 VUL		REF G/L	N° fonderie/ Casting		REF D/R	N° fonderie/ Casting
BREMBO PF 2.48	MERCEDES SPRINTER, VOLKSWAGEN CRAFTER		EFR065	928901		EFR066	928901
BREMBO PF 2.48	NISSAN NV400, OPEL MOVANO, RENAULT MASTER		EFR087	8200735266; A51004		EFR088	8200735269; A51005
BENDIX PF 2.52	NISSAN CABSTAR, RT B SERIE (V1)		EFR005	21342599; 216072		EFR006	21342599; 216072
BENDIX PF 2.52	NISSAN CABSTAR, RT B SERIE (V2)		EFR005	21342599; 216072		EFR006	21342599; 216072
BREMBO PF 2.52	IVECO DAILY, NISSAN CABSTAR, RT MAXITY (avec support/ with carrier)		522.7301.28	730239; 730302; 22730118		522.7301.29	730239; 730302; 22730119




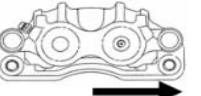










CLASSIFICATION ETRIER DE FREIN PAR TYPE
BRAKE CALIPERS CLASSIFICATION BY TYPE



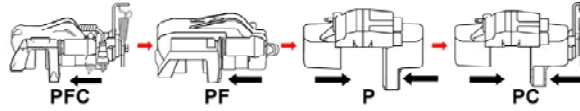
TYPE	VUL		REF G/L	N° fonderie/ Casting		REF D/R	N° fonderie/ Casting
BREMBO PF 2.52	MERCEDES SPRINTER (avec support/ with carrier)		522.7301.50	730207; 22730300		522.7301.60	730207; 22730300
BREMBO PF 2.52	RT MASCOTT (avec support/ with carrier)		522.7301.73	730239; 730302;		522.7301.83	730239; 730302;
BREMBO PF 2.52	NISSAN NT500 (avec support/ with carrier)		522.7301.74			522.7301.84	
BREMBO PF 2.52	MERCEDES SPRINTER, VOLKSWAGEN CRAFTER		EFR077	929302		EFR078	929302
AKEBONO PF 2.54	ISUZU NPR 3,5T		EFR083	A934Y		EFR084	A935Y
MERITOR PF 2.58	VOLVO FL SERIE (avec support/ with carrier)		EFR019	68320203; 68320195; 68320197		EFR020	68320203; 68320195; 68320197













CLASSIFICATION ETRIER DE FREIN PAR TYPE
BRAKE CALIPERS CLASSIFICATION BY TYPE



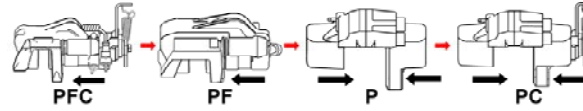
 TYPE			REF G/L	N° fonderie/ Casting		REF D/R	N° fonderie/ Casting
ATE/TEVES PF 2.60	MERCEDES		EFR122			EFR123	
BREMBO PF 2.60	IVECO EUROCARGO 60 (avec support/ with carrier)		522.5760.08	576201; 578301; 22576015		522.5760.09	576201; 578301; 22576025
BREMBO PF 2.60	IVECO DAILY (avec support/ with carrier)		522.9788.10	576201; 576101; 576306; 22978808		522.9788.20	576201; 576101; 576306; 22978809
BREMBO PF 2.60	IVECO EUROCARGO (avec support/ with carrier)		522.9800.08	980801; 881301; 981201; 22980006		522.9800.09	980801; 881301; 981201; 22980007
MERITOR PF 2.60	MERCEDES BM668 - BM669 - VARIO (avec support/ with carrier)		EFR023	31320099; 68320760; 31320083		EFR024	31320100; 68320760; 31320083

CLASSIFICATION ETRIER DE FREIN PAR TYPE
BRAKE CALIPERS CLASSIFICATION BY TYPE



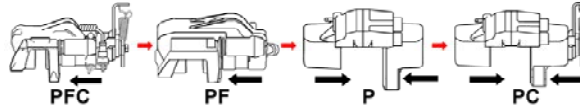
TYPE	VUL	←	REF G/L	N° fonderie/ Casting	→	REF D/R	N° fonderie/ Casting
MERITOR PF 2.60	MERCEDES BM668 - BM669 - VARIO (avec support/ with carrier)		EFR025	31320099; 68320760; 31320083		EFR026	31320100; 68320760; 31320083
MERITOR PF 2.60	RT MIDLINER (avec support/ with carrier)		EFR035	68320704; 68320760; 31320083		EFR036	68320704; 68320760; 31320083
MERITOR PF 2.60	IVECO EUROCARGO (avec support/ with carrier)		EFR162	68320338; 68320760; 31320083		EFR163	68320338; 68320760; 31320083
BREMBO PF 2.68	IVECO EUROCARGO (avec support/ with carrier)		522.5660.08	566101; 566202; 22566014		522.5660.09	566101; 566202; 22566024
BREMBO PF 2.68	IVECO EUROCARGO (avec support/ with carrier)		522.9802.08	981001; 881301; 981201; 22980206		522.9802.09	981001; 881301; 981201; 22980207
MERITOR PF 2.68	VOLVO FL-FS SERIE (avec support/ with carrier)		EFR021	68320203; 68320195; 68320197		EFR022	68320203; 68320195; 68320197

CLASSIFICATION ETRIER DE FREIN PAR TYPE
BRAKE CALIPERS CLASSIFICATION BY TYPE



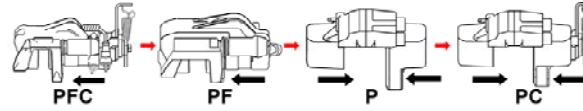
 TYPE			REF G/L	N° fonderie/ Casting		REF D/R	N° fonderie/ Casting
MERITOR PF 2.68	RT MIDLINER (avec support/ with carrier)		EFR037	68320714; 68320190; 68320197		EFR038	68320714; 68320760; 31320083
MERITOR PF 2.68	NISSAN ATLEON (avec support/ with carrier)		EFR160	68320756; 68320190; 68320197		EFR161	68320756; 68320190; 68320197
MERITOR PF 2.68	IVECO EUROCARGO (avec support/ with carrier)		EFR166	68320639; 68320190; 68320197		EFR167	68320639; 68320190; 68320197
KNOTT P 2.46	MULTICAR M26, M27, M28		EFR118			EFR119	
ATE/TEVES P 2.54	MERCEDES MB TRAC; UNIMOG		EFR093			EFR094	



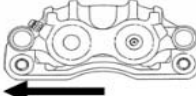











CLASSIFICATION ETRIER DE FREIN PAR TYPE
BRAKE CALIPERS CLASSIFICATION BY TYPE



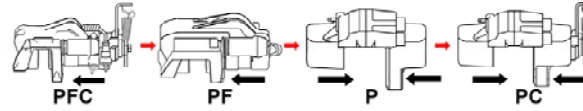
 TYPE			REF G/L	N° fonderie/ Casting		REF D/R	N° fonderie/ Casting
ATE/TEVES P 2.54	VOLKSWAGEN TRANSPORTER		EFR146			EFR147	
ATE/TEVES P 2.57	VOLKSWAGEN LT28, LT31, LT35		EFR138			EFR139	
ATE/TEVES P 2.57	VW LT40-55		EFR124			EFR125	
ATE/TEVES P 2.57	VW LT40-55		EFR136			EFR137	















CLASSIFICATION ETRIER DE FREIN PAR TYPE
BRAKE CALIPERS CLASSIFICATION BY TYPE



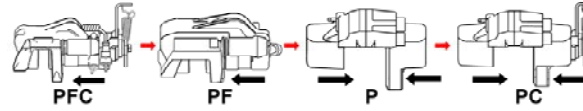
 TYPE			REF G/L	N° fonderie/ Casting		REF D/R	N° fonderie/ Casting
ATE/TEVES P 2.60	MERCEDES MB TRAC		EFR085	18G		EFR086	11G
ATE/TEVES P 2.60	MERCEDES UNIMOG		EFR112	123G		EFR113	123G
AP LOCKHEED P 4.41	DAF 400 series; LDV CONVOY		EFR061			EFR062	
AP LOCKHEED P 4.41	IVECO DAILY		EFR130			EFR131	
AP LOCKHEED P 4.41	IVECO DAILY		EFR132			EFR133	

CLASSIFICATION ETRIER DE FREIN PAR TYPE
BRAKE CALIPERS CLASSIFICATION BY TYPE



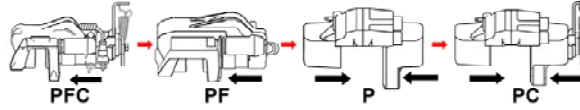
TYPE	VUL		REF G/L	N° fonderie/ Casting		REF D/R	N° fonderie/ Casting
BREMBO P 4.42	IVECO DAILY		520.4910.82	2036850; 20388601		520.4910.83	2038850; 20388701
BREMBO P 4.42	IVECO DAILY		520.4910.84	2036850; 20388601		520.4910.85	2038850; 20388701
ATE/TEVES P 4.44	MERCEDES T1		EFR053			EFR054	70P
ATE/TEVES P 4.44	MERCEDES T1		EFR055	38P; 22P		EFR056	45P; 26P
BREMBO P 4.44	IVECO DAILY (avec plaquettes/ with pads)		520.5150.11			520.5150.21	
PERROT P 4.44	IVECO DAILY		EFR043	624290388		EFR044	624290388




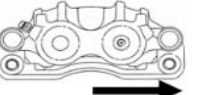










CLASSIFICATION ETRIER DE FREIN PAR TYPE
BRAKE CALIPERS CLASSIFICATION BY TYPE



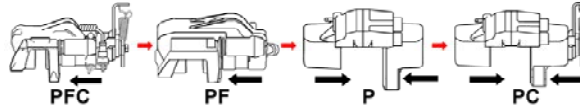
TYPE	VUL		REF G/L	N° fonderie/ Casting		REF D/R	N° fonderie/ Casting
PERROT P 4.44	MERCEDES T1		EFR047	624140982		EFR048	14183012
PERROT P 4.44	MERCEDES T1		EFR049	0113X624;		EFR050	0123X624;
AP LOCKHEED P 4.46	DAF 400 series, LDV CONVOY		EFR063	3247683C; VB3		EFR064	
GIRLING P 4.48	RENAULT MASTER, BRIMONT		EFR140	MJ20		EFR141	MJ20
BREMBO P 4.50	IVECO DAILY 59 (interchangeable)		520.9576.10			520.9576.20	
PERROT P 4.50	IVECO DAILY 59		EFR045	14183035		EFR046	14183035




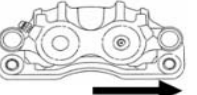






CLASSIFICATION ETRIER DE FREIN PAR TYPE
BRAKE CALIPERS CLASSIFICATION BY TYPE



 TYPE			REF G/L	N° fonderie/ Casting		REF D/R	N° fonderie/ Casting
PERROT P 4.56	DAF 45 (6-8 t.)		EFR039			EFR040	
PERROT P 4.65	DAF 45 (8-11 t.)		EFR041			EFR042	
SEE PAM P 4.67	RT MIDLINER		EFR001	77093		EFR002	77093
ATE/TEVES P 4.48/57	MERCEDES UNIMOG		EFR110	22G		EFR111	1R
ATE/TEVES P 4.48/57	MERCEDES UNIMOG		EFR114	1P		EFR115	1P

**CLASSIFICATION ETRIER DE FREIN PAR TYPE
BRAKE CALIPERS CLASSIFICATION BY TYPE**

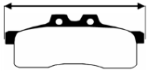



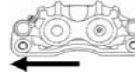


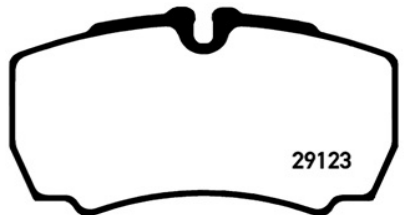
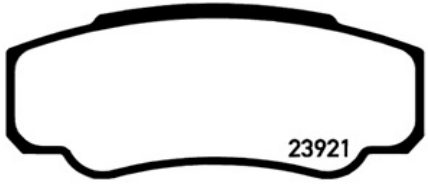
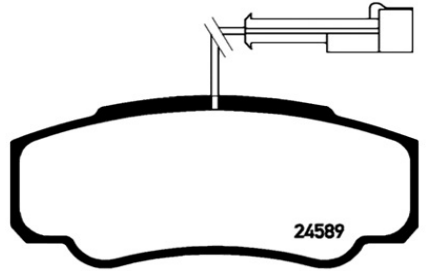
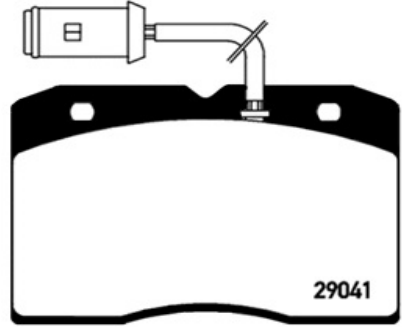


 TYPE			REF G/L	N° fonderie/ Casting		REF D/R	N° fonderie/ Casting
SEE PAM P 6.67	IRISBUS FR1		EFR003	77518		EFR004	77518
ATE/TEVES PC 2.54	MERCEDES MB TRAC, UNIMOG		EFR106	440009; 72486		EFR107	440010; 2647
ATE/TEVES PC 2.54	MERCEDES UNIMOG		EFR116	27G		EFR117	28G; CL86





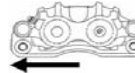


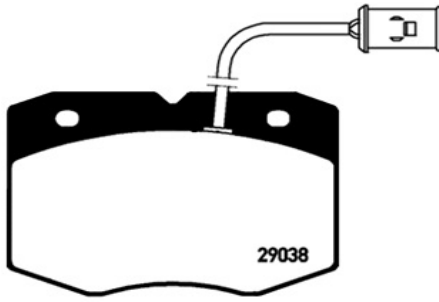
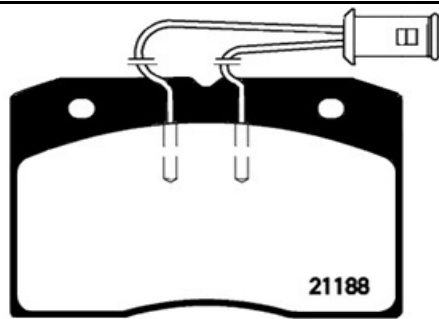
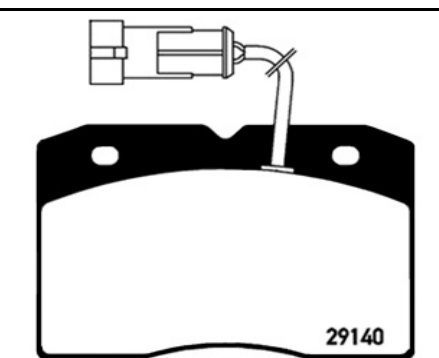
**RECHERCHE PLAQUETTES DE FREIN PAR DIMENSIONS
BRAKE PADS RESEARCH BY SIZE**

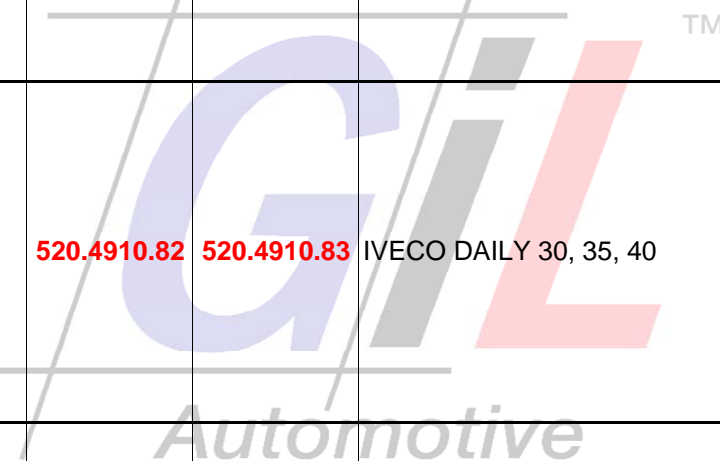
		IMAGE / DRAWING	W.V.A ALT.N.	OBS					
89,7	73,8		29581	TH : 15 mm	2958104 FDB143	ATE/TEVES P 2.60	EFR085	EFR086	MERCEDES MB TRAC
						ATE/TEVES P 2.54	EFR093	EFR094	MERCEDES MB TRAC, UNIMOG
						ATE/TEVES PC 2.54	EFR106	EFR107	
				TH : 19 mm	2958105	ATE/TEVES P 2.60	EFR112	EFR113	MERCEDES UNIMOG TM
						ATE/TEVES PC 2.54	EFR116	EFR117	
94,6	57,3		23980		2398001 FVR1516	TRW/LUCAS PFC 1.41	EFR017	EFR018	NISSAN PRIMASTAR, OPEL VIVARO, RENAULT TRAFIC
104,9	74,7		20759 20359	1 ENTREE	2035907 FVR839	AP LOCKHEED P 4.41	EFR130	EFR131	IVECO DAILY 35
				2 ENTREES			EFR132	EFR133	
104,9	74,7		20359	TU-	2035908 FVR829	AP LOCKHEED P 4.41	EFR061	EFR062	DAF 400, LDV CONVOY

**RECHERCHE PLAQUETTES DE FREIN PAR DIMENSIONS
BRAKE PADS RESEARCH BY SIZE**





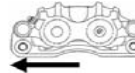


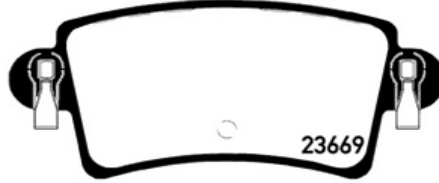


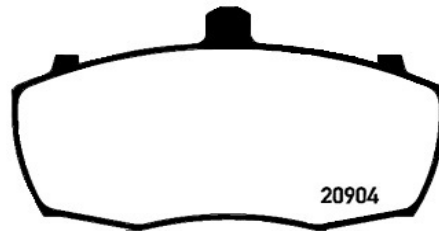
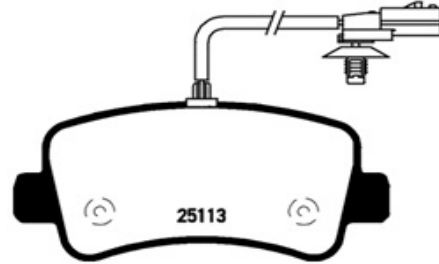
		IMAGE / DRAWING	W.V.A ALTN.	OBS		 TYPE			
109,5	63,8	 29123	29123		507.7273.12 2912303 FVR1405	BREMBO PFC 1.52	522.7270.52	522.7270.62	IVECO DAILY S
					507.7273.16 2912303 FVR4140				IVECO DAILY 2006
109,7	49,9	 23921	23921	AR.	2392101 FVR1480	BREMBO PF 1.46	522.8153.12	522.8153.22	CITROËN JUMPER, FIAT DUCATO, PEUGEOT BOXER
109,7	49,9	 24589	23921 24589	TU+	507.8156.42 2392103 FVR4054	BREMBO PFC 1.46	522.9715.75	522.9715.85	NISSAN CABSTAR, RENAULT TRUCKS MAXITY
109,7	73,0	 29041	29041 29048	TU+	507.4146.48 2904101 FVR655	BREMBO P 4.42	520.4910.82	520.4910.83	IVECO DAILY 30, 35, 40

RECHERCHE PLAQUETTES DE FREIN PAR DIMENSIONS BRAKE PADS RESEARCH BY SIZE

		IMAGE / DRAWING	W.V.A ALTN.	OBS					
109,7	73,0		29037 29038	TU+	507.4146.49 2903701 FVR713	BREMBO P 4.42	520.4910.84	520.4910.85	IVECO DAILY 30
					507.4146.86 2903701 FVR713				
109,7	73,0		21188 21048	TU+	507.4146.51 2118801 FVR511	BREMBO P 4.42	520.4910.82	520.4910.83	IVECO DAILY 30, 35, 40
					507.4146.61 2118801 FVR511				
109,7	73,0		29140 21048	TU+	507.4146.85 2914001 FVR1353	BREMBO P 4.42	520.4910.82	520.4910.83	IVECO DAILY 30, 35, 40











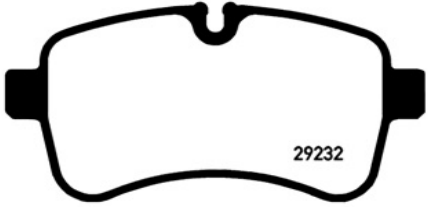
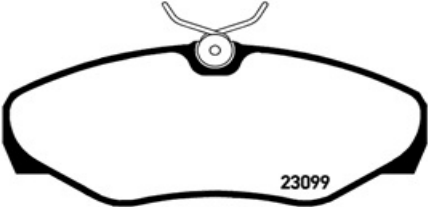
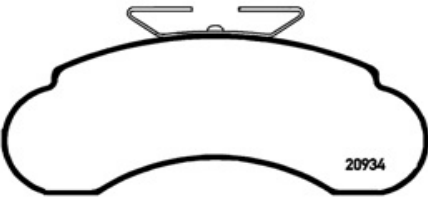
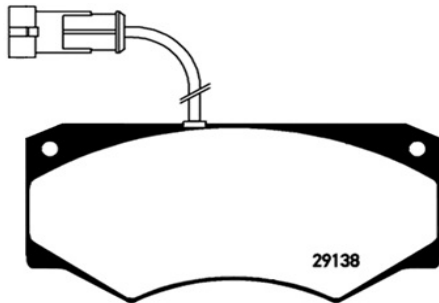
**RECHERCHE PLAQUETTES DE FREIN PAR DIMENSIONS
BRAKE PADS RESEARCH BY SIZE**

		IMAGE / DRAWING	W.V.A ALTN.	OBS		 TYPE			
115,7	51,3		23669		2366901 FVR1453	BOSCH PFC 1.42	EFR013	EFR014	NISSAN INTERSTAR, OPEL MOVANO, RENAULT MASTER
123,1	56,6		29240 29241	(8 pieces)	2924001 FVR4253	SUMITOMO	EFRXXX	EFRXXX	MITSUBISHI CANTER
125,0	60,0		29242 29243	(8 pieces)	2924201 FVR1906	SUMITOMO PF 1.48	EFR069 EFR071	EFR070 EFR072	MITSUBISHI CANTER
126,7	71,2		20904		2090401 FVR836	AP LOCKHEED P 4.46	EFR063	EFR064	DAF 400, LDV CONVOY
128,5	59,4		25112 25113	R. SIMPLE	2511201 FVR4348	BREMBO PFC 1.48	EFR089	EFR090	RENAULT MASTER





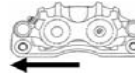


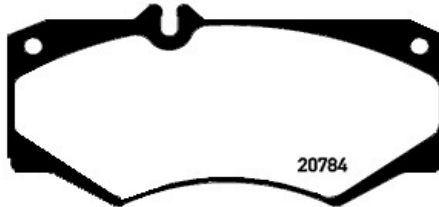
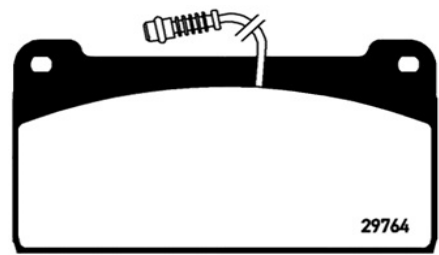
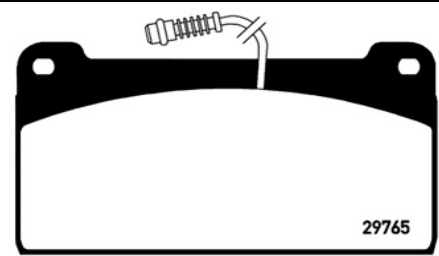
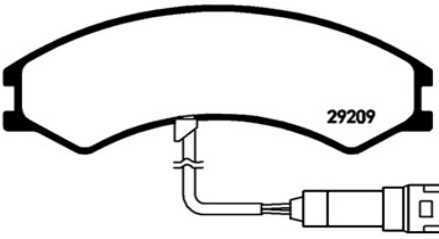

**RECHERCHE PLAQUETTES DE FREIN PAR DIMENSIONS
BRAKE PADS RESEARCH BY SIZE**

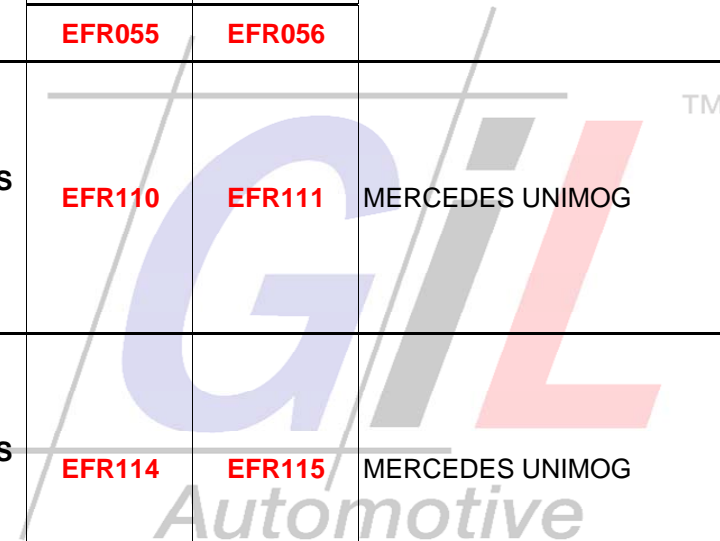
		IMAGE / DRAWING	W.V.A ALTN.	OBS					
137,0	63,0		29190		2919001 TU+ FVR1780 TU+	BOSCH PF 1.51	EFR073	EFR074	MERCEDES SPRINTER, VOLKSWAGEN CRAFTER
138,7	66,7		23302		2330201 FVR1292	BOSCH PF 2.45	EFR007	EFR008	OPEL MOVANO, RENAULT MASTER
138,7	79,8		23613		2361301 FVR1452	BOSCH PF 2.45	EFR009	EFR010	NISSAN INTERSTAR, OPEL MOVANO, RENAULT MASTER
							EFR011	EFR012	RENAULT MASTER
139,2	58,9		29249 29250 29251	8 pieces	2924901 FVR4314	SUMITOMO	EFRXXX	EFRXXX	MITSUBISHI CANTER
140,5	65,6		23917 23918	ABS-	2391701 FVR1478	BREMBO PF 2.44/48	522.8142.45	522.8142.55	CITROËN JUMPER, FIAT DUCATO, PEUGEOT BOXER
				ABS+			522.8142.46	522.8142.56	

**RECHERCHE PLAQUETTES DE FREIN PAR DIMENSIONS
BRAKE PADS RESEARCH BY SIZE**





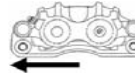






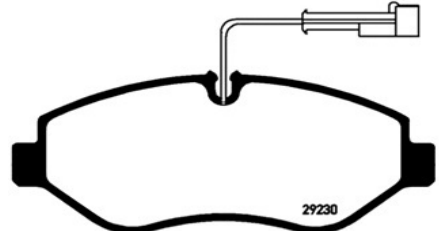
		IMAGE / DRAWING	W.V.A ALTN.	OBS					
141,3	46,5		24739 24740 21621		2473901 FVR1039	ATE	EFRXXX	EFRXXX	MERCEDES, VOLKSWAGEN
141,3	72,7		29232		507.9724.10 2923201 FVR4037	BREMBO PFC 1.60	522.9721.00	522.9721.01	IVECO DAILY 2006
145,1	62,4		23099		2309902 FVR1515	TRW/LUCAS PF 2.40/45	EFR015	EFR016	NISSAN PRIMASTAR, OPEL VIVARO, RENAULT TRAFIC
145,5	59,0		21573 20934		2157302 FVR941	BENDIX PF 2.48	EFR067	EFR068	MERCEDES MB100 D
149,0	69,0		29138 20465		2913801 FVR1351	PERROT P 4.44	EFR043	EFR044	IVECO DAILY 35, 40
					507.4146.87 2913801 FVR1351	BREMBO P 4.44	520.5150.11	520.5150.21	IVECO DAILY 40

RECHERCHE PLAQUETTES DE FREIN PAR DIMENSIONS BRAKE PADS RESEARCH BY SIZE





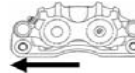


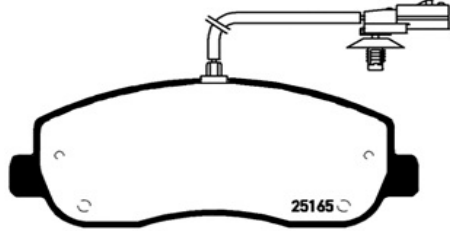
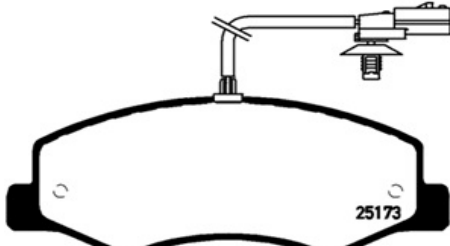
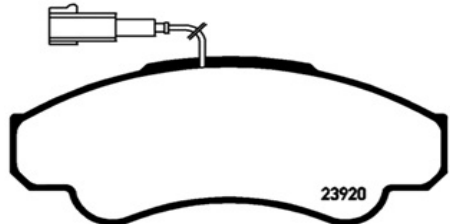
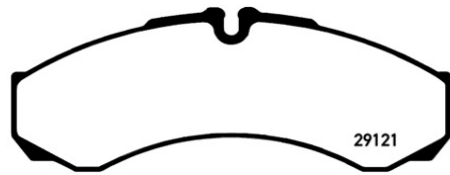

		IMAGE / DRAWING	W.V.A ALTN.	OBS					
149,0	75,0		20784 29784	1 ENTREE	2078401 FVR239	PERROT P 4.44			MERCEDES T1
				2 ENTREES					
				1 ENTREE					
				2 ENTREES					
149,7	81,5		29764 29324	2 TU+	2976402 FCV958	ATE/TEVES P 4.48/57			MERCEDES UNIMOG
149,7	81,5		29765	4 TU+	2976502 FCV959	ATE/TEVES P 4.48/57			MERCEDES UNIMOG
150,1	56,2		29208 29209		2920801 FVR1761	KNOTT P 2.46			MULTICAR M26
156,4	54,3		23901 23902 21592		2390101 FVR1876	ATE	EFRXXX	EFRXXX	MERCEDES, VOLKSWAGEN







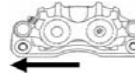


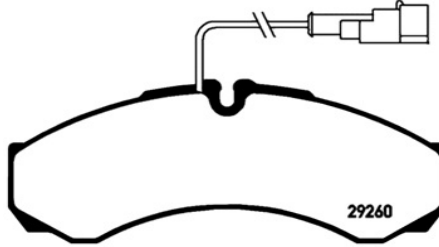


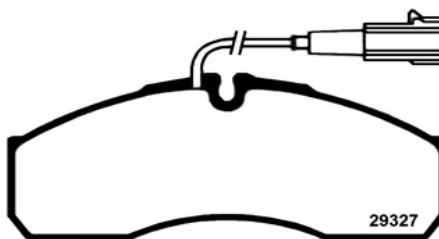
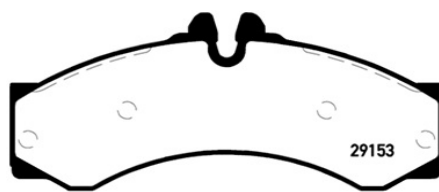
**RECHERCHE PLAQUETTES DE FREIN PAR DIMENSIONS
BRAKE PADS RESEARCH BY SIZE**

		IMAGE / DRAWING	W.V.A ALTN.	OBS					
156,5	64,8		23990 23991 21576		2399002 FVR1038	ATE	EFRXXX	EFRXXX	MERCEDES, VOLKSWAGEN
160,1	59,9		22087		2208701 FVR4840	TRW	EFRXXX	EFRXXX	OPEL, RENAULT
163,3	67,1		29192		2919202 TU+ FVR1778 TU-	BREMBO PF 2.48	EFR065	EFR066	MERCEDES SPRINTER, VOLKSWAGEN CRAFTER
163,3	67,2		29229		507.9703.10 2922901 FVR4036	BREMBO PF 2.48	522.9700.10	522.9700.20	IVECO DAILY 2006
163,3	67,2		29230 29229	TU+	507.9703.16 2922902 FVR4053	BREMBO PF 2.48	522.9700.76	522.9700.86	NISSAN CABSTAR, RENAULT TRUCKS MAXITY









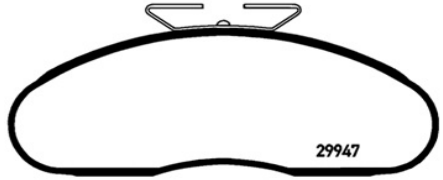
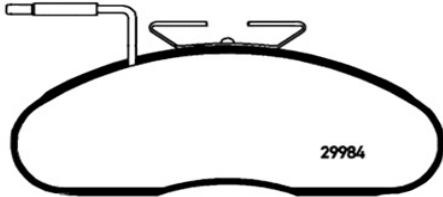
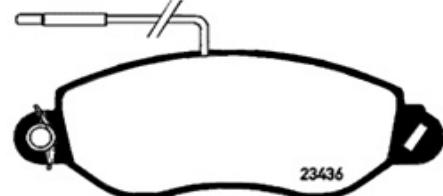
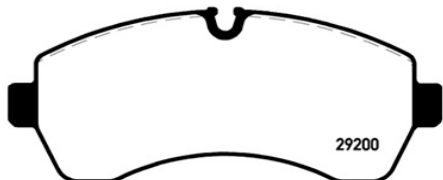
**RECHERCHE PLAQUETTES DE FREIN PAR DIMENSIONS
BRAKE PADS RESEARCH BY SIZE**

		IMAGE / DRAWING	W.V.A ALTN.	OBS		 TYPE			 VUL
163,4	64,7		25147 25165	AV.	2514701 FVR4347	BREMBO PF 2.48	EFR087	EFR088	RENAULT MASTER
163,6	62,8		25172 25173	R. JUMELEE	2517201 FVR4349	BREMBO PFC 1.60	EFR091	EFR092	RENAULT MASTER
164,5	68,7		23919 23920	ABS- ABS+	2391901 FVR1479	BREMBO PF 2.46/52	522.8148.45	522.8148.55 522.8148.46 522.8148.56	CITROËN JUMPER, FIAT DUCATO, PEUGEOT BOXER
164,6	66,8		29121 29357 29374	TH : 17 mm	507.5444.32 2912111	BREMBO PF 2.42	522.7220.01	522.7220.02	IVECO DAILY S
					507.5944.32 2912111 FVR1315	BREMBO PF 2.46	522.7306.28	522.7306.29	RENAULT TRUCKS MASCOTT
						BREMBO PF 2.44	522.7773.73 522.7775.73 522.9272.01	522.7773.83 522.7775.83 522.9272.02	RENAULT MASTER, RENAULT TRUCKS IVECO DAILY S
164,6	66,8		29121 29357 29374	TH : 20,3 mm	507.5944.11 2912112 FVR1102	BREMBO PF 2.46	522.7306.28	522.7306.29	IVECO DAILY C 65
						BREMBO PF 2.44	522.7773.28 522.7775.28	522.7773.29 522.7775.29	IVECO DAILY (96), DAILY C





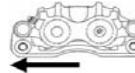


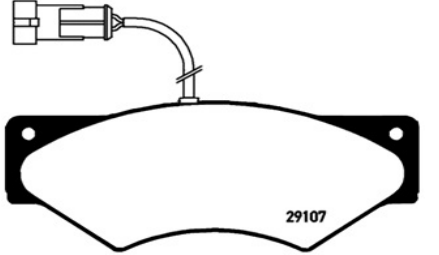
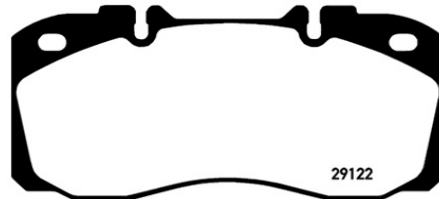
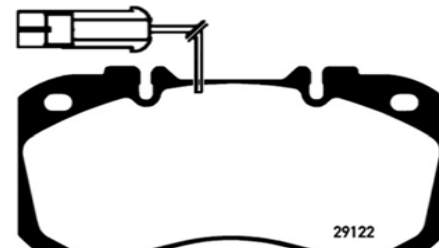


**RECHERCHE PLAQUETTES DE FREIN PAR DIMENSIONS
BRAKE PADS RESEARCH BY SIZE**

		IMAGE / DRAWING	W.V.A ALTN.	OBS		 TYPE			
164,6	66,8	 29260	29121 29260	TH : 20,3 TU+	507.5944.54 2912113 FVR4156	BREMBO PF 2.44	522.7775.28	522.7775.29	NISSAN CABSTAR, RENAULT TRUCKS MAXITY
164,7	67,8	 29160	29160		507.7304.18 2916002 FVR1390	BREMBO PF 2.52	522.7301.28	522.7301.29	IVECO DAILY C
							522.7301.73	522.7301.83	RENAULT TRUCKS MASCOTT
164,7	67,8	 29237	29237		2923701 FVR1791	BREMBO PF 2.52	522.7301.50	522.7301.60	MERCEDES SPRINTER
164,7	67,8	 29327	29327	TU+	2932701 FVR4248	BREMBO PF 2.52	522.7301.28	522.7301.29	NISSAN CABSTAR, RENAULT TRUCKS MAXITY
164,7	73,0	 29153	29153 29076		2915301 FVR1879	PERROT PF 2.44 V1	EFR051	EFR052	MERCEDES SPRINTER VARIO, VOLKSWAGEN LT
						PERROT PF 2.44 V2	EFR128	EFR129	MERCEDES SPRINTER
						BOSCH PF 2.45 V1	EFR095	EFR096	MERCEDES SPRINTER, VOLKSWAGEN LT
						BOSCH PF 2.45 V2	EFR126	EFR127	MERCEDES SPRINTER





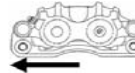


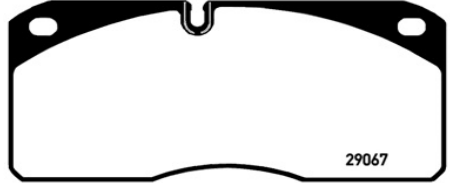
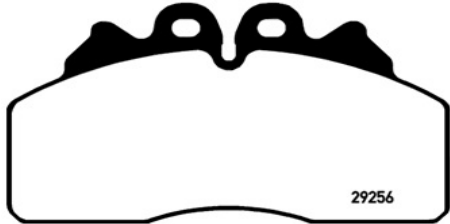
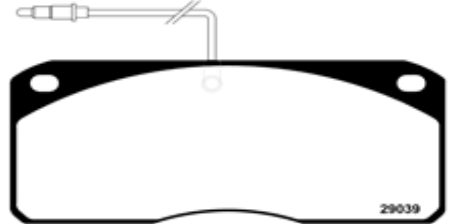


**RECHERCHE PLAQUETTES DE FREIN PAR DIMENSIONS
BRAKE PADS RESEARCH BY SIZE**

		IMAGE / DRAWING	W.V.A ALTN.	OBS					
165,0	79,0		29217		2921702 TU- FVR1779 TU- FVR4429 TU+	BOSCH PF 2.48	EFR075	EFR076	MERCEDES SPRINTER, VOLKSWAGEN CRAFTER
166,6	62,0		29071 29947		2907102 FVR627	BENDIX PF 2.52	EFR005	EFR006	RENAULT TRUCKS B SERIE
166,6	62,0		29984 29985 29706		2998401 FVR792	BENDIX PF 2.52	EFR005	EFR006	NISSAN CABSTAR
						BENDIX PF 2.48	EFR081	EFR082	
168,9	65,0		23435 23434 23436 23437		2343501 FVR1616	BOSCH PF 2.48	EFR079	EFR080	NISSAN CABSTAR
169,3	73,5		29200		2920002 FVR1779	BREMBO PF 2.52	EFR077	EFR078	MERCEDES SPRINTER, VOLKSWAGEN CRAFTER





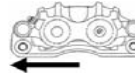


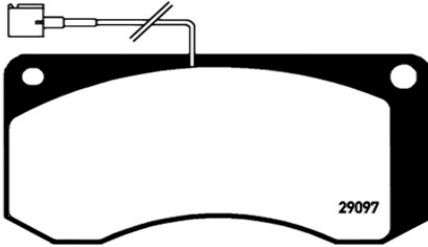
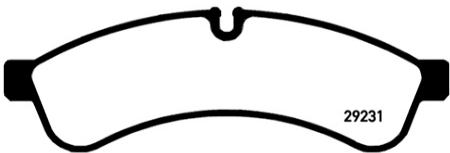
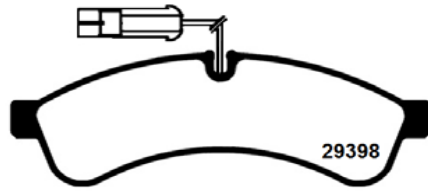
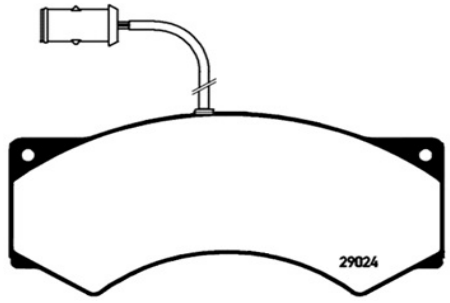
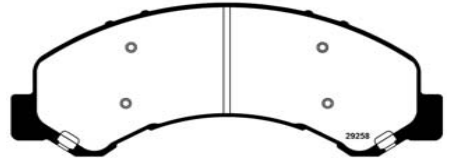
**RECHERCHE PLAQUETTES DE FREIN PAR DIMENSIONS
BRAKE PADS RESEARCH BY SIZE**

		IMAGE / DRAWING	W.V.A ALTN.	OBS		 TYPE			
174,6	69,2	 29107	29107 29001		2910701 FVR1350	BREMBO P 4.50	520.9576.10	520.9576.20	IVECO DAILY 59
						PERROT P 4.50	EFR045	EFR046	
174,8	85,3	 29122	29122		507.5901.21 2912204 FCV1126	BREMBO PF 2.60	522.5760.08	522.5760.09	IVECO EUROCARGO 60
						BREMBO PFC 2.60	522.5770.16	522.5770.26	
						507.5901.30 2912204	BREMBO PF 2.60	522.9788.10	522.9788.20
174,8	85,3	 29122	29122			BREMBO PF 2.60			NISSAN NT500 RENAULT TRUCKS D SERIE
174,8	85,6	 29065	29065		2906504 FCV879	MERITOR PF 2.60	EFR035	EFR036	RENAULT TRUCKS MIDLINER
174,8	85,6	 29835	29835		2983506 FVR1522B	MERITOR PF 2.60	EFR023	EFR024	MERCEDES BM668 - BM669 VARIO
						MERITOR PFC 2.60	EFR025	EFR026	
						MERITOR PFC 2.54	EFR031	EFR032	MERCEDES VARIO
						EFR033	EFR034		
						EFR108	EFR109		MERCEDES SPRINTER





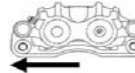


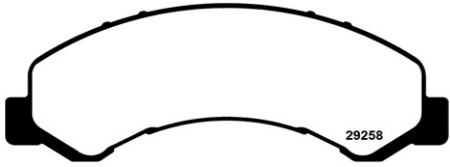
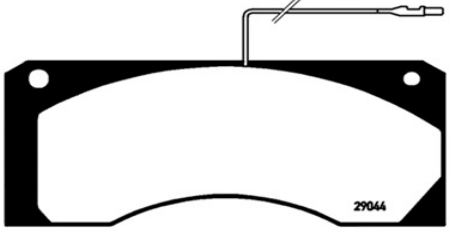
**RECHERCHE PLAQUETTES DE FREIN PAR DIMENSIONS
BRAKE PADS RESEARCH BY SIZE**

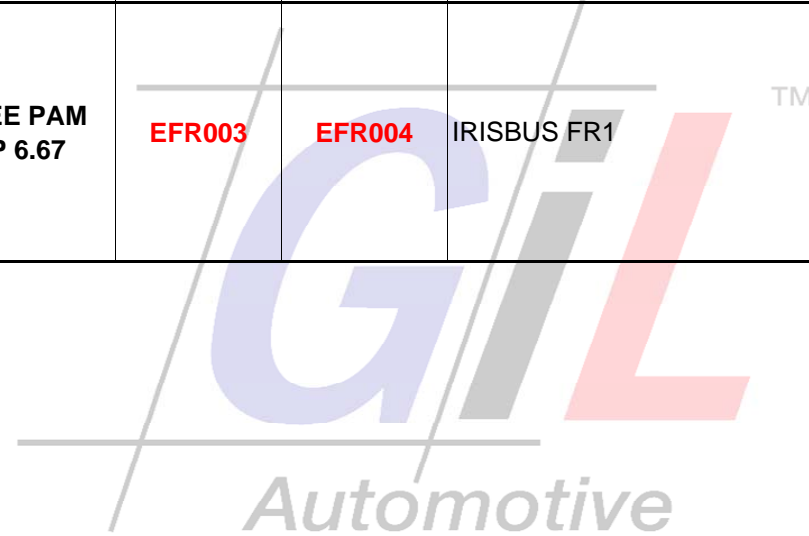
		IMAGE / DRAWING	W.V.A ALTN.	OBS		 TYPE			
175,4	78,0	 29067	29067		2906705 FCV733	MERITOR PF 2.68	EFR037	EFR038	RENAULT TRUCKS MIDLINER
					507.5664.31 2906705 FCV733	BREMBO PF 2.68	522.5660.08	522.5660.09	IVECO EUROCARGO 80
175,4	95,0	 29256	29256		507.9814.21 2925601 G1020915 FCV4254	BREMBO PF 2.60	522.9800.08	522.9800.09	IVECO EUROCARGO 70
					G1020915 FCV4254	BREMBO PFC 2.60	522.9801.08	522.9801.09	IVECO EUROCARGO 70
					507.9814.11 2925601 G1020915 FCV4254	BREMBO PF 2.68	522.9802.08	522.9802.09	IVECO EUROCARGO 100
					G1020915 FCV4254	BREMBO PFC 2.68	522.9803.08	522.9803.09	IVECO EUROCARGO 100
175,5	78,2	 29039	29039 29302		2903902 FCV702	MERITOR PF 2.58	EFR019	EFR020	VOLVO FL SERIE AV.
						MERITOR PFC 2.58	EFR027	EFR028	VOLVO FL SERIE AR.
						MERITOR PF 2.68	EFR021	EFR022	VOLVO FL, FS SERIE AV.
						MERITOR PFC 2.68	EFR029	EFR030	VOLVO FL SERIE AR.
178,0	67,9				PF1580	AKEBONO	EFRXXX	EFRXXX	ISUZU NPR NQR 7,5T AR.
180,2	86,0	 29013	29013 29014		2901302 FCV668	SEE PAM P 4.67	EFR001	EFR002	RENAULT TRUCKS MIDLINER

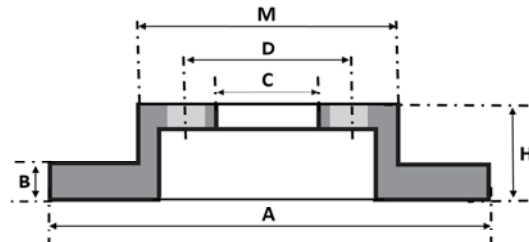
**RECHERCHE PLAQUETTES DE FREIN PAR DIMENSIONS
BRAKE PADS RESEARCH BY SIZE**


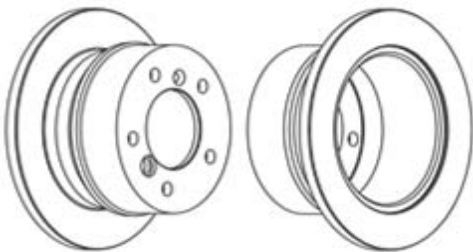
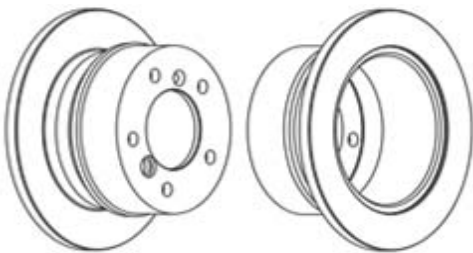
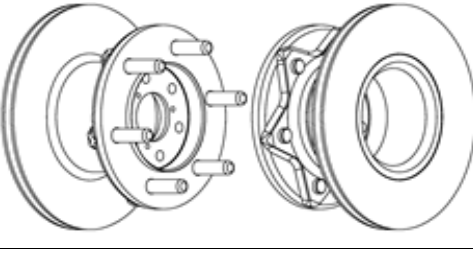
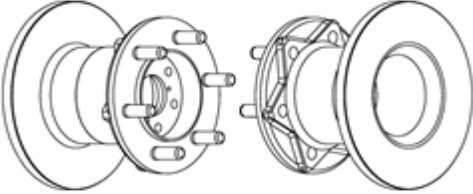
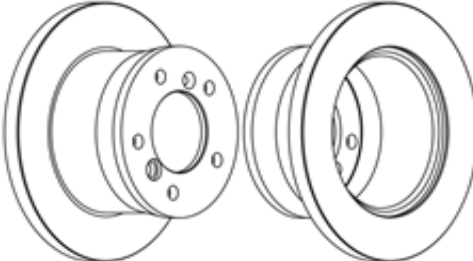
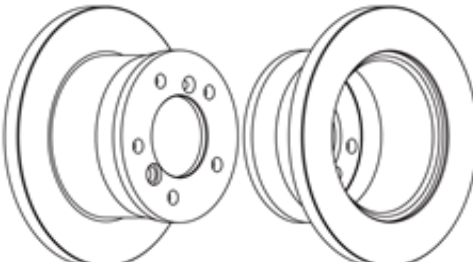
		IMAGE / DRAWING	W.V.A ALTN.	OBS					
180,2	86,0		29097 29098		2909702 FCV1046	SEE PAM P 4.67	EFR001	EFR002	RENAULT TRUCKS MIDLINER
184,2	64,8		29231		507.9786.10 2923101 FVR4039	BREMBO PF 2.48	522.9782.10	522.9782.20	IVECO DAILY 2006
184,2	64,8		29231 29398		2923103	BREMBO PF 2.xx			NISSAN NT500 RENAULT TRUCKS D SERIE
191,2	87,9		29017 29024		2901704 FCV503	PERROT P 4.56	EFR039	EFR040	DAF 45 (6-8 t.)
						PERROT P 4.65	EFR041	EFR042	DAF 45 (8-11 t.)
206,2	80,0		29258		PF1236 FCV1853	AKEBONO PF 2.	EFRXXX	EFRXXX	ISUZU NPR NQR 7,5T

**RECHERCHE PLAQUETTES DE FREIN PAR DIMENSIONS
BRAKE PADS RESEARCH BY SIZE**

		IMAGE / DRAWING	W.V.A ALTN.	OBS					
206,4	74,8		25800		PF1235 FCV5000B	AKEBONO PF 2.54	EFR083	EFR084	ISUZU NPR 3,5T
235,9	95,0		29044 29130		2904402 FCV1940	SEE PAM P 6.67	EFR003	EFR004	IRISBUS FR1



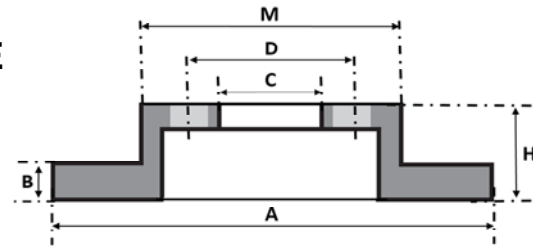


REF / PN	P V	A	H	B	B min.	nb trous	C	D	fixation	M	Kg	ILLUSTRATIONS / DRAWING	 (OBS)
08.7724.10	P	258	96,5	12,0	10,0	5	85,0	130,0	1	180,4	6,2		MERCEDES - VW (DIH)
08.7724.20 92137503 FCR230A	P	258	96,5	12,0	10,0	5	85,0	130,0	1	180,4	6,2		MERCEDES - VW (DIH)
08.3907.10 93019400 DDF089-1	P	267	111,0	14,2	12,8	6	58,3	95,0		219,0	10,4		IVECO DAILY
08.5374.10 93084400 DDF254-1	P	267	154,0	14,2	12,4	6	58,3	95,0	6	221,0	12,4		IVECO DAILY
08.7725.10	P	272	96,5	16,0	14,0	5	85,0	130,0	1	180,4	7,0		MERCEDES - VW (DIH)
08.7725.20 92137603 FCR229A	P	272	96,5	16,0	14,0	5	85,0	130,0	1	180,4	7,0		MERCEDES - VW (DIH)

P:disque plein/solid disc

V:disque ventilé/vented disc

Les dessins de disque de frein proviennent/Brake disc drawing come from Federal Mogul



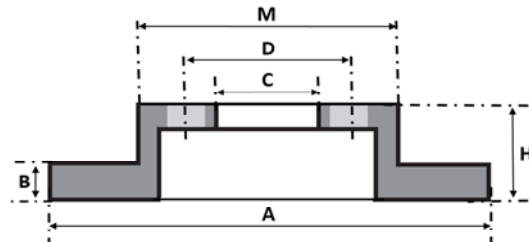
REF / PN	P V	A	H	B	B min.	nb trous	C	D	fixation	M	Kg	ILLUSTRATIONS / DRAWING	(OBS)
08.7219.10 93104600 FCR194A	P	276	67,0	22,0	20,4	5	73,1	118,0	2	157,0	8,3		IVECO DAILY
08.7300.10 93104700 FCR195A	P	276	69,5	16,0	13,0	5	73,1	118,0	2	157,0	6,8		IVECO DAILY (ABS-)
08.7300.20 93104800 FCR196A	P	276	69,5	16,0	13,0	5	73,1	118,0	2	157,0	6,8		IVECO DAILY (ABS+)
08.9794.10 FCR327A	P	280	62,2	16,0	13,0	6	108,0	127,0		179,0	6,5		RT MAXITY NISSAN CABSTAR (ABS-)
08.9794.60 FCR369A	P	280	62,2	16,0	13,0	6	108,0	127,0		179,0	7,0		RT MAXITY NISSAN CABSTAR (ABS+)

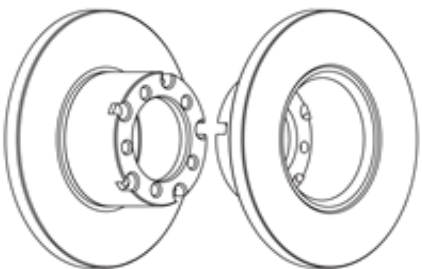
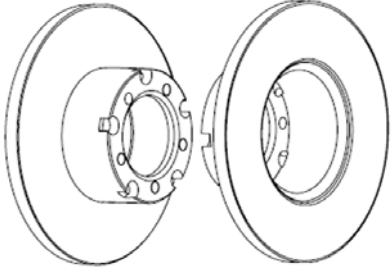
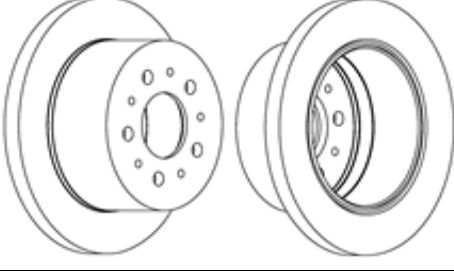
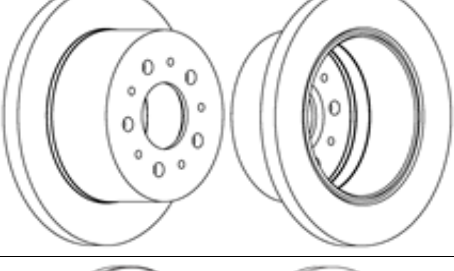
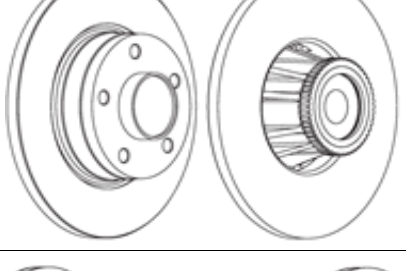
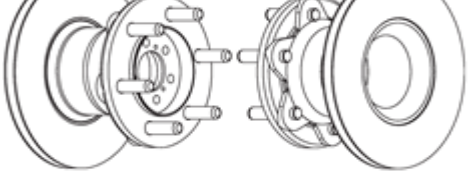


P:disque plein/solid disc

V:disque ventilé/vented disc

Les dessins de disque de frein proviennent/Brake disc drawing come from Federal Mogul

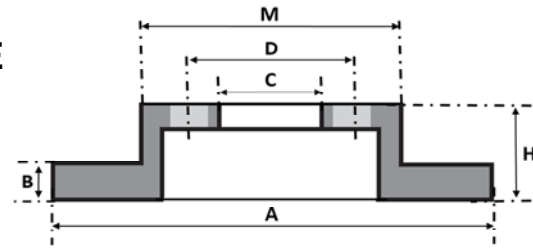


REF / PN	P V	A	H	B	B min.	nb trous	C	D	fixation	M	Kg	ILLUSTRATIONS / DRAWING	VUL (OBS)
08.3959.20 93012400 FCR116A	P	280	78,6	16,0	13,0	5	112,0	88,0	5	145,8	7,0		MERCEDES 207D
08.6923.20 93054600 FCR117A	P	280	78,7	22,0	19,0	5	88,0	112,0	5	145,8	8,7		MERCEDES 407D
08.8094.30 92116103 DDF1144C	P	280	82,0	16,0	14,2	5	72,0	118,0	5	186,0	7,6		CITROËN-FIAT- PEUGEOT
08.8094.40 92116203 DDF1145	P	280	82,0	16,0	14,2	5	79,0	130,0	5	186,0	7,6		CITROËN-FIAT- PEUGEOT
08.9597.17 92153703 DDF1623-1	P	280	102,5	12,0	10,0	5	71,0	118,0		154,0	9,1		NISSAN-OPEL- RENAULT (Bearing+)
08.5079.10 93042801 FCR104A	P	280	142,0	16,0	14,5	6	58,3	85,0	6	224,0	13,3		IVECO DAILY (GOUJONS +)

P:disque plein/solid disc

V:disque ventilé/vented disc

Les dessins de disque de frein proviennent/Brake disc drawing come from Federal Mogul

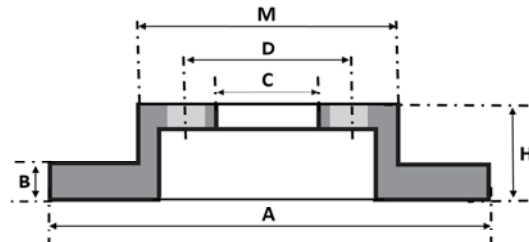



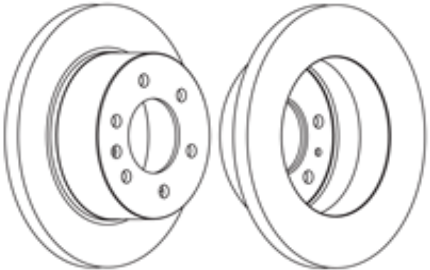
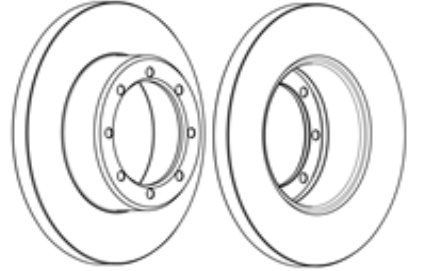
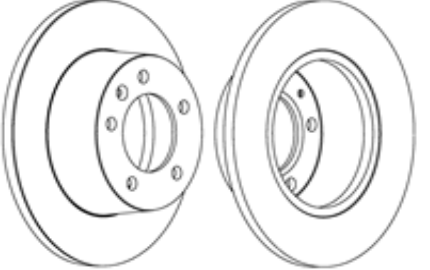
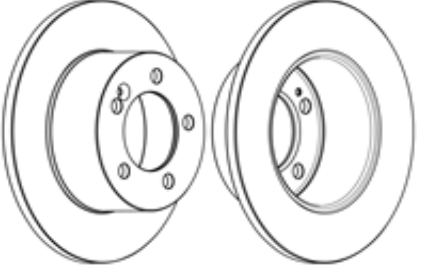
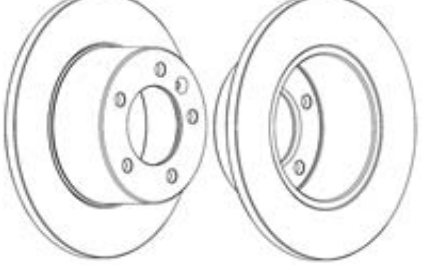
REF / PN	P V	A	H	B	B min.	nb trous	C	D	fixation	M	Kg	ILLUSTRATIONS / DRAWING	VUL (OBS)
08.5952.10 93089600 FCR140A	P	289	84,5	22,0	19,0	8	84,0	108,0		186,0	9,5		IVECO DAILY (DIH)
08.5959.10 93095100 FCR139A	P	290	111,0	22,0	19,0	6	68,0	95,0	6	220,0	14,5		IVECO DAILY (GOUJONS +)
08.9459.20 93175400 FCR313A	P	290	111,0	22,0	19,0	6	122,9	170,0	6	220,0	14,8		IVECO DAILY (GOUJONS +)
08.9759.10 93229100 FCR315A	P	296	69,5	16,0	13,0	6	76,0	125,0	1	170,0	8,6		IVECO DAILY (ABS-)
08.9759.20 93177500 FCR316A	P	296	69,5	16,0	13,0	6	76,0	125,0	1	170,0	7,6		IVECO DAILY (ABS+)
08.A260.10 FCR343A	P	297	77,5	22,0	19,0	6	85,1	150,0		193,8	9,5		IVECO DAILY 4X4

P:disque plein/solid disc

V:disque ventilé/vented disc

Les dessins de disque de frein proviennent/Brake disc drawing come from Federal Mogul

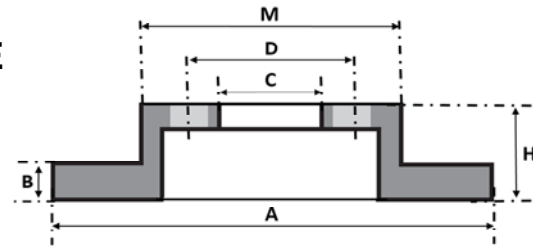


REF / PN	P V	A	H	B	B min.	nb trous	C	D	fixation	M	Kg	ILLUSTRATIONS / DRAWING	 (OBS)
08.9509.14 93143303 FCR311A	P	298	71,0	16,0	14,0	6	85,0	130,0	1	190,0	7,3		MERCEDES - VW (DIH - Screw+)
08.A650.10 92230800 DDF1977C	P	302	51,0	18,0	15,0	8	120,1	140,0		178,5	7,7		MASTER III AR ROUE JUMEELEE PROPULSION
08.9371.10 92111203 DDF1272C	P	305	66,7	12,0	10,5	5	90,1	130,0	1	179,2	6,7		RENAULT MASTER II
08.A651.10 92228800 DDF1976C	P	305	71,5	12,0	10,0	5	91,1	130,0	1	185,0	6,8		MASTER III AR ROUE SIMPLE PROPULSION
08.B829.10 92228700 DDF1975C	P	305	71,5	12,0	10,5	5	90,1	130,0	1	179,2	6,5		MASTER III AR TRACTION

P:disque plein/solid disc

V:disque ventilé/vented disc

Les dessins de disque de frein proviennent/Brake disc drawing come from Federal Mogul

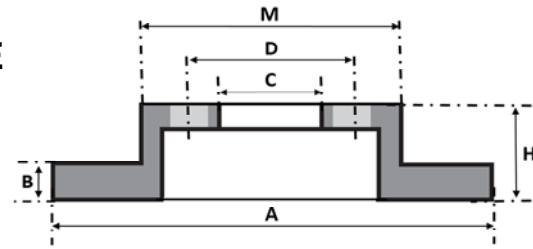


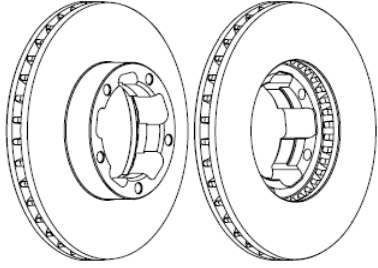
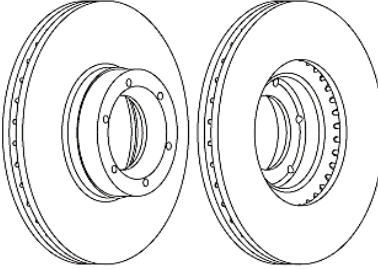
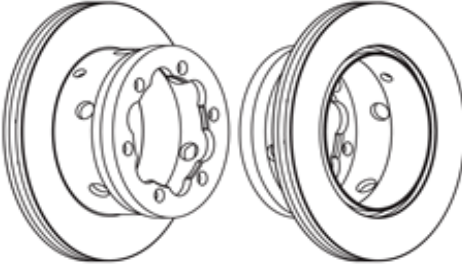
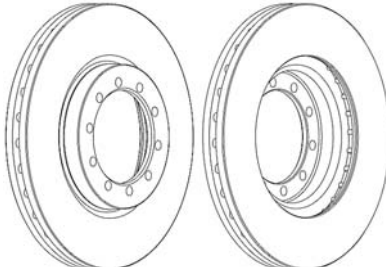
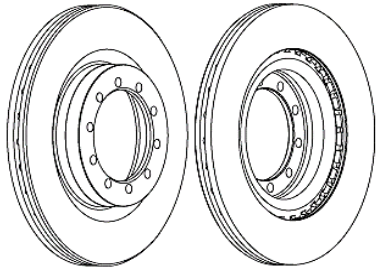
REF / PN	P V	A	H	B	B min.	nb trous	C	D	fixation	M	Kg	ILLUSTRATIONS / DRAWING	VUL (OBS)
08.7772.10 93127300 FCR236A	P	306	114,5	22,0	19,0	6	178,3	215,0		190,1	14,1		IVECO DAILY (DIH)
08.6750.10 93066400 FCR156A	P	374	22,0	22,0	20,5	10	60,3	108,0		60,3	15,3		MERCEDES MB TRAC - UNIMOG
08.6750.20 93015500 FCR364A	P	374	22,0	22,0	20,5	10	80,3	108,0		80,3	15,0		MERCEDES MB TRAC - UNIMOG
09.6734.20 93085800 FCR169A	V	276	44,0	24,0	22,0	10	102,0	120,0		148,0	6,7		RENAULT GAMME B
09.B410.10 FCR326A	V	276	45,2	28,0	25,0	5	94,1	118,0		143,0	7,6		RT MAXITY NISSAN CABSTAR

P:disque plein/solid disc

V:disque ventilé/vented disc

Les dessins de disque de frein proviennent/Brake disc drawing come from Federal Mogul

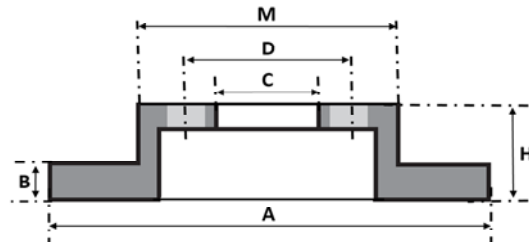


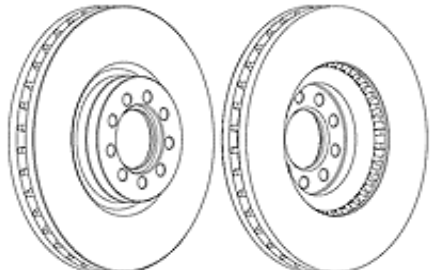
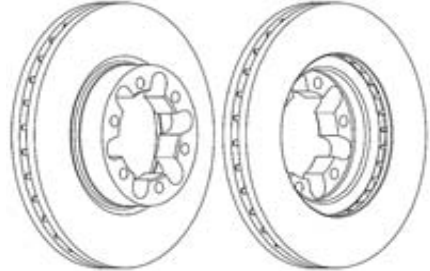
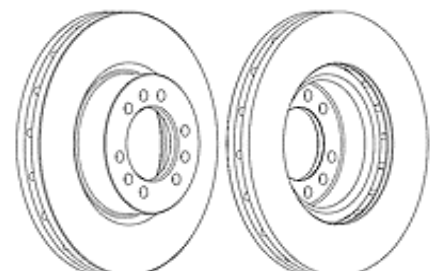
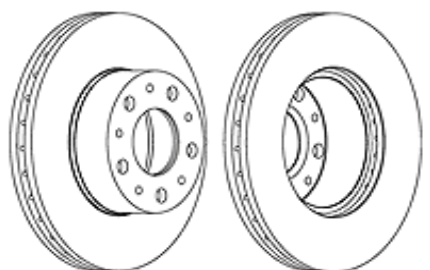
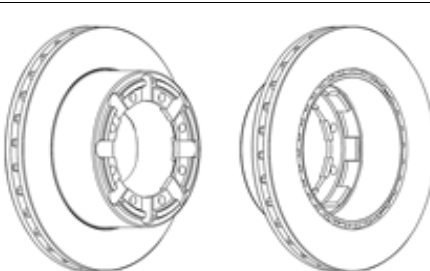
REF / PN	P V	A	H	B	B min.	nb trous	C	D	fixation	M	Kg	ILLUSTRATIONS / DRAWING	(OBS)
09.B497.10 93185303 FCR261A	V	278	49,6	24,2	22,0	5	96,1	118,0		146,0	7,0		NISSAN CABSTAR 276 MM 5 TROUS
09.7717.10 92097703 DDF1067C	V	280	61,6	24,0	21,0	6	79,5	110,0		135,3	7,3		RENAULT MASTER II
09.8475.10 92089803 FCR191A	V	285	96,0	22,0	19,0	6	120,0	145,0		188,5	7,3		MERCEDES SPRINTER (DIH)
09.7261.10 93117500 FCR182A	V	290	42,5	26,0	23,0	10	102,1	120,0		158,0	7,5		RENAULT TRUCKS MASCOTT
09.7262.10 93117400 FCR183A	V	290	42,5	22,0	19,0	10	102,1	120,0		158,0	6,7		RENAULT TRUCKS MASCOTT

P:disque plein/solid disc

V:disque ventilé/vented disc

Les dessins de disque de frein proviennent/Brake disc drawing come from Federal Mogul

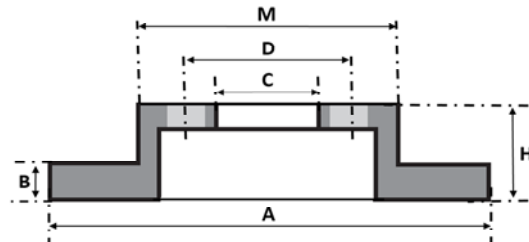



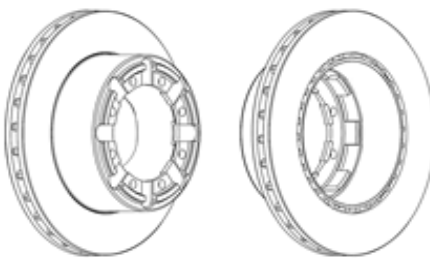
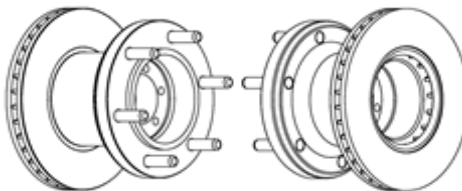

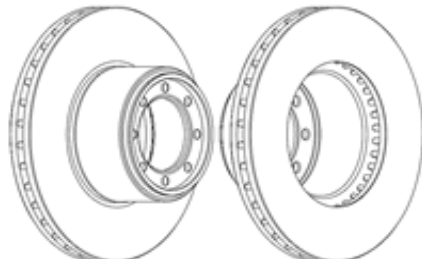
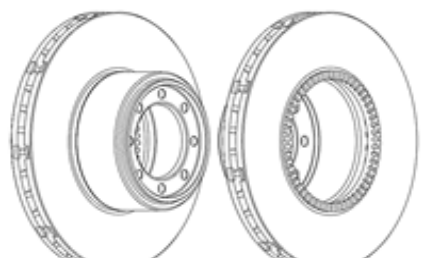

REF / PN	P V	A	H	B	B min.	nb trous	C	D	fixation	M	Kg	ILLUSTRATIONS / DRAWING	VUL (OBS)
09.9760.10 92155700 FCR317A	V	290	46,0	28,0	25,0	9	84,0	95,0		137,0	8,5		IVECO DAILY
09.8965.10 93240600 FCR339A	V	290	53,0	26,0	23,0	6	96,1	118,0		154,0	8,1		RT MAXITY NISSAN CABSTAR
09.7723.10 93127200 FCR235A	V	290	53,0	26,0	23,0	9	80,0	110,0		154,0	7,7		IVECO DAILY
09.8931.20 92275103 DDF1170C	V	290	66,0	24,0	22,0	5	73,0	118,0		155,0	7,5		CITROËN-FIAT- PEUGEOT
09.7263.20 93117600 FCR184A	V	290	78,0	22,0	19,0	8	150,0	132,0		186,0	7,9		RENAULT MASCOTT AR (DIH)

P:disque plein/solid disc

V:disque ventilé/vented disc

Les dessins de disque de frein proviennent/Brake disc drawing come from Federal Mogul

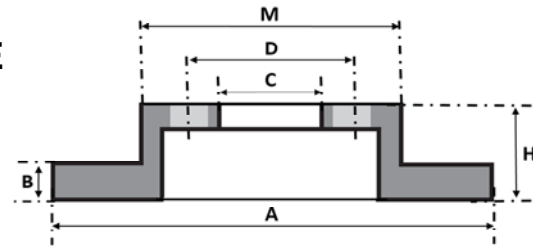


REF / PN	P V	A	H	B	B min.	nb trous	C	D	fixation	M	Kg	ILLUSTRATIONS / DRAWING	 (OBS)
09.7263.30 FCR340A	V	290	78,0	22,0	19,0	8	145,0	127,0		186,0	7,8		NISSAN CABSTAR ATLEON - RT MAXITY (DIH)
09.6957.20 93084500 FCR133A	V	290	160,0	25,0	23,0	6	120,0	100,0	6	251,0	21,3		IVECO DAILY 59-12 (GOUJONS +)
DF6392	V	293	58,0	40,0	37,0	12	110,0	136,0		180,7	12,0		ISUZU
09.9761.10 93175300 FCR320A	V	294	83,5	24,0	21,0	8	84,0	108,0		156,0	8,3		IVECO DAILY (ABS-)
09.9761.60 92171700 FCR321A	V	294	83,5	24,0	21,0	8	84,0	108,0		156,0	8,7		IVECO DAILY (ABS+)
92268803 DDF2507C	V	296	44,0	28,0	23,4	5	68,0	114,3	2	159,0	9,0		RENAULT TRAFIC

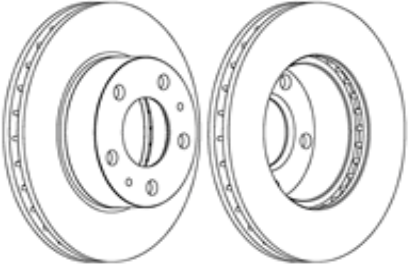
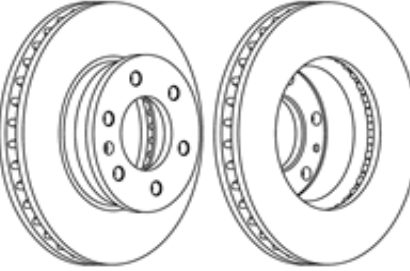
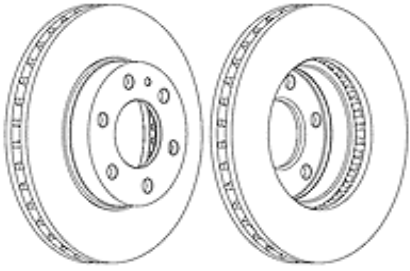
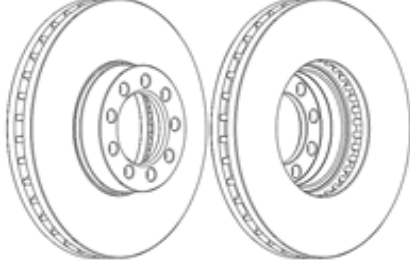
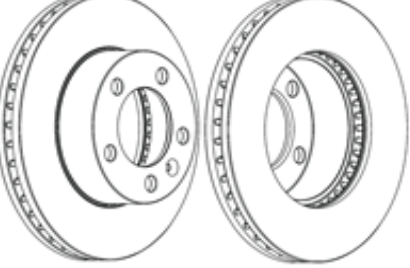
P:disque plein/solid disc

V:disque ventilé/vented disc

Les dessins de disque de frein proviennent/Brake disc drawing come from Federal Mogul



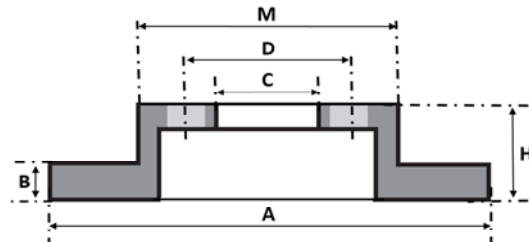
(OBS)


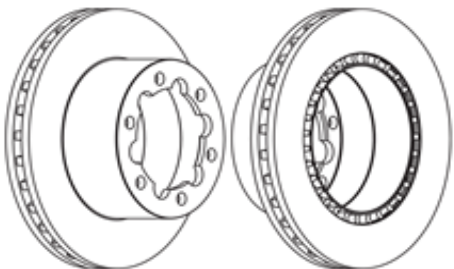
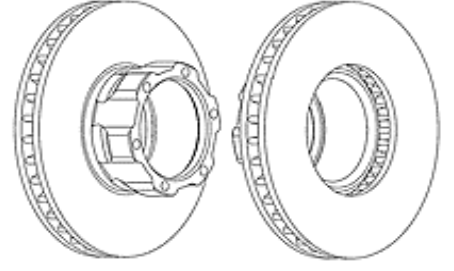
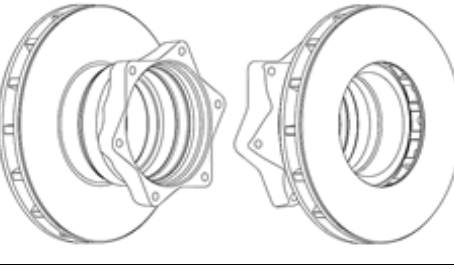
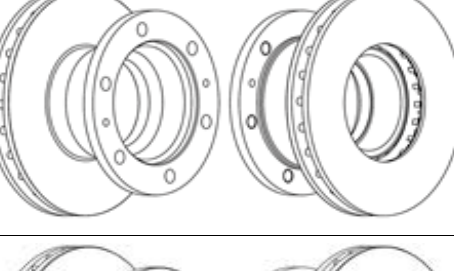
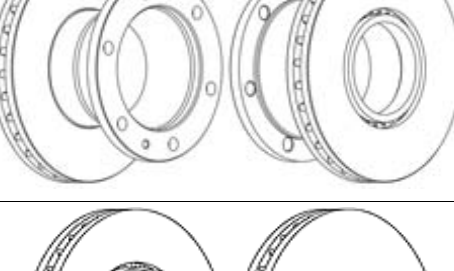
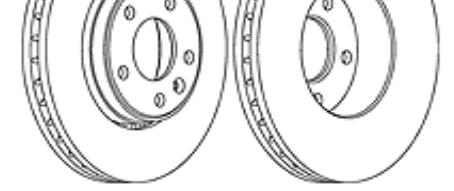
REF / PN	P V	A	H	B	B min.	nb trous	C	D	fixation	M	Kg	ILLUSTRATIONS / DRAWING	
09.8932.10 92116703 DDF768C	V	300	65,5	24,0	21,9	5	80,0	130,0	5	174,0	7,9		CITROËN-FIAT- PEUGEOT
09.9508.14 93143203 FCR310A	V	300	68,5	28,0	25,0	6	85,0	130,0	1	180,4	9,2		MERCEDES - VW
09.9758.10 92155900 FCR314A	V	300	74,5	28,0	25,0	6	78,5	125,0	1	167,5	8,6		IVECO DAILY
09.9762.10 93177603 FCR329A	V	301	59,0	30,0	27,0	9	83,0	111,0		147,5	10,4		IVECO DAILY
09.B633.10 92228600 DDF1974C-1	V	302	69,8	28,0	24,5	5	90,1	130,0	1	147,3	9,3		MASTER IV AV

P:disque plein/solid disc

V:disque ventilé/vented disc

Les dessins de disque de frein proviennent/Brake disc drawing come from Federal Mogul

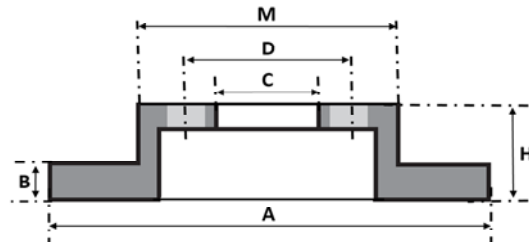


REF / PN	P V	A	H	B	B min.	nb trous	C	D	fixation	M	Kg	ILLUSTRATIONS / DRAWING	 (OBS)
09.9510.14 93143403 FCR312A	V	303	93,0	28,0	25,0	6	120,1	145,0		186,0	9,6		MERCEDES - VW (DIH)
09.6998.10 93087400 FCR118A	V	304	91,0	30,0	26,0	6	118,0	140,0		160,0	10,5		MERCEDES VARIO
09.8206.10 93087500 FCR164A	V	304	120,0	30,0	26,0	6	157,1	192,0		217,0	11,4		MERCEDES VARIO
09.6813.20 93084800 FCR105A	V	304	128,5	30,0	27,8	6	165,0	205,0	2	245,0	13,8		IVECO EUROCARGO (ABS-)
09.6813.60 FCR322A	V	304	128,5	30,0	27,8	6	165,0	205,0	2	245,0	14,1		IVECO EUROCARGO (ABS+)
09.8937.10 92116003 DDF1204C-1	V	305	49,4	28,0	24,0	5	72,1	118,0	1	165,0	9,0		RENAULT TRAFIC II

P:disque plein/solid disc

V:disque ventilé/vented disc

Les dessins de disque de frein proviennent/Brake disc drawing come from Federal Mogul

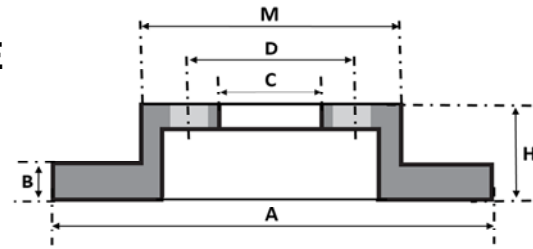


REF / PN	P V	A	H	B	B min.	nb trous	C	D	fixation	M	Kg	ILLUSTRATIONS / DRAWING	VUL (OBS)
09.9080.10 92115903 DDF1217C-1	V	305	78,0	28,0	25,0	5	90,1	130,0	1	171,8	9,8		RENAULT MASTER II
09.9763.10 93177703 FCR332A	V	306	132,0	28,0	25,0	6	178,3	215,0		253,0	13,3		IVECO DAILY (DIH)
DF6393	V	310	55,6	42,0	39,0	12	110,0	136,0		180,7	12,0		ISUZU
09.7323.10 93084200 FCR102A	V	312	137,0	30,0	27,0	12	133,4	155,0		192,8	14,7		DAF
09.5797.10 93084100 FCR101A	V	315	121,7	26,0	24,0	10	119,5	138,0		159,5	12,6		DAF
09.7322.20 93086400 FCR130A	V	322	90,0	30,0	28,0	6	132,0	154,0		178,0	13,0		VOLVO FL

P:disque plein/solid disc

V:disque ventilé/vented disc

Les dessins de disque de frein proviennent/Brake disc drawing come from Federal Mogul

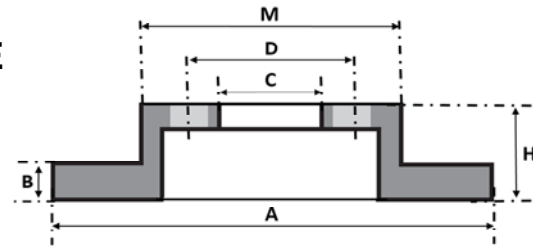



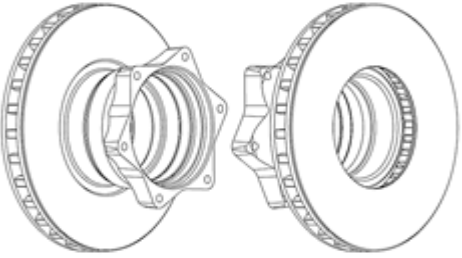
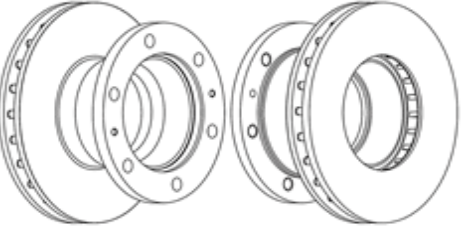
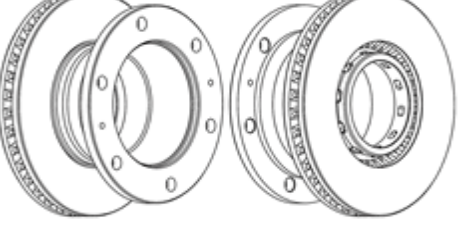
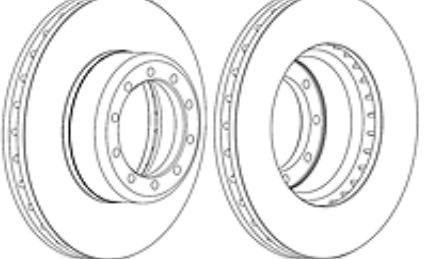
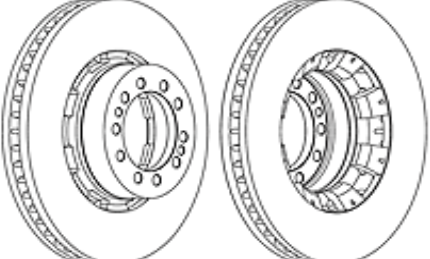
REF / PN	P V	A	H	B	B min.	nb trous	C	D	fixation	M	Kg	ILLUSTRATIONS / DRAWING	VUL (OBS)
09.7322.10 93058800 FCR131A	✓	322	90,0	30,0	28,0	8	132,0	154,0		178,0	13,0		VOLVO FL
09.9745.10 93128200 FCR306A	✓	322	115,0	30,0	28,0	6	164,1	190,0		216,3	13,8		VOLVO FL
09.6763.20 93084900 FCR106A	✓	322	134,0	30,0	27,8	8	215,0	275,0	2	320,0	17,3		IVECO EUROCARGO (ABS-)
09.6763.60 FCR341A	✓	322	134,0	30,0	27,8	8	215,0	275,0	2	320,0	17,9		IVECO EUROCARGO (ABS+)
09.9746.10 93086500 FCR142A	✓	323	138,0	30,0	27,0	8	216,1	275,0		308,0	16,0		VOLVO FL
09.6969.10 93087600 FCR163A	✓	324	91,0	30,0	26,0	6	118,0	140,0		160,0	11,4		MERCEDES VARIO

P:disque plein/solid disc

V:disque ventilé/vented disc

Les dessins de disque de frein proviennent/Brake disc drawing come from Federal Mogul



REF / PN	P V	A	H	B	B min.	nb trous	C	D	fixation	M	Kg	ILLUSTRATIONS / DRAWING	 (OBS)
09.8205.10 93087700 FCR165A	V	324	120,0	30,0	26,0	6	157,1	192,0		217,0	12,0		MERCEDES VARIO
09.A315.10 93221300 FCR338A	V	330	129,5	32,0	29,0	6	185,1	245,0	2	292,0	17,9		IVECO EUROCARGO (ABS-)
09.A315.60 93221200 FCR342A	V	330	129,5	32,0	29,0	6	185,1	245,0	2	292,0	19,1		IVECO EUROCARGO (ABS+)
09.6732.20 93085900 FCR126A	V	354	82,0	30,0	26,0	10	128,0	151,0		199,0	14,0		RENAULT TRUCKS MIDLINER
09.7956.10 93086200 FCR128A	V	400	90,0	42,0	36,0	12	175,0	197,0		237,0	23,7		IRISBUS FR1

P:disque plein/solid disc

V:disque ventilé/vented disc

Les dessins de disque de frein proviennent/Brake disc drawing come from Federal Mogul



SYSTEM



DAF

400 series

428-435 1375Kg	04.89-08.93	AP	MC0621	22,20	
428-435 1450/1500/1600Kg	04.89-08.93	AP	MC0622	23,81	

IVECO

DAILY GRINTA

18 Q.	01.80-12.96		MC0110	25,40	
28.8, 30.8, 32.8, 35.10 Turbo, 35.12 Turbo, 40.10 Turbo	01.80-12.96		MC0092	20,64	
30.9, 35.8, 35.9, 35.10, 40.8, 40.10	01.80-12.96		MC0161	22,22	

DAILY I

35.8; 35.10; 35.12 V, C	01.96-12.99		MC0235	25,40	
35.10; 35.12 V, C	01.96-12.99		MC0431	26,99	Fourni sans le servo
45.10TD; 45.12; 49.10TD; 49.12TD	01.96-12.99		MC0431	26,99	Fourni sans le servo

DAILY II

35C9, 11V, 13V, 15V	01.99-04.06		MC0235	25,40	
35S9, S11, S13, S15	01.99-04.06		MC0468	23,81	
65C15 2.8TD	01.99-04.06		MC0460	28,60	Fourni sans le servo

ZETA

50.8; 60.10; 65.12;	11.79-03.91		MC0623	25,40	
50.10; 60.10; 60.8; 60.11; 65.9; 65.10; 65.12 V;	01.79-03.91		MC0625	25,40	
65.12 H; 65.12 V; 79.14; 95.14; 109.14; 109.14 H;	06.83-03.91		MC0624	28,57	
79-10; 79-13; 79-14; 95-14; 109-14;	11.79-03.91		MC0627	38,10	

EUROCARGO

75 E12, E14, E15; 80 E15, E18, E21			MC0100	31,75	
100 E18, E21; 150 E15, E18, E23, E27			MC0100	31,75	
60 E10, E12, E14; 65 E10, E12, E14			MC0101	33,33	

BUS - DIVERS

308 - 314 - 370 Bus - 100.13 - 110N-80 - 90 - 100 - 110 - 130 - 643 - 645 - 662 - 673	-02.04		MC0626	44,45	
---	--------	--	---------------	-------	--

LDV

CONVOY

428-435 1375Kg	09.93-	AP	MC0621	22,20	
428-435 1450/1500/1600Kg	09.93-	AP	MC0622	23,81	



SYSTEM



MERCEDES

T1 (601-602)

207-307 D	04.77-01.90		MC0618	23,81	
207-307 D	04.77-01.90		MC0620	25,40	

SPRINTER (901, 902)

208 D (-ABS)	01.95-04.00		MC0093	20,64	
214 (-ABS)	02.95-05.06		MC0093	20,64	
208CDI; 208D; 210D; 211CDI; 213CDI; 214, NGT; 216CDI	02.95-05.06	BOSCH	MC0308	23,81	< Ch n° A906425 & R400727
208CDI; 211CDI; 213CDI; 216CDI	01.00-05.06	TRW	MC0617	23,81	Ch n° A906426 & R400728>, Alu

SPRINTER (903)

308 D (-ABS)	02.95-04.00		MC0093	20,64	
314 (-ABS)	02.95-05.06		MC0093	20,64	
308CDI; 308D; 308 E; 310D; 311CDI; 312D; 313CDI; 314, NGT; 316CDI	02.95-05.06	BOSCH	MC0308	23,81	< Ch n° A906425 & R400727
308CDI; 311CDI; 313CDI; 316CDI	01.00-05.06	TRW	MC0617	23,81	Ch n° A906426 & R400728>, Alu

SPRINTER (904)

408CDI; 408D; 410D; 411CDI; 412D; 413CDI; 414; 416CDI	02.95-05.06	BOSCH	MC0473	25,40	< Ch n° A906425 & R400727
408CDI; 411CDI; 413CDI; 416CDI	01.00-05.06	TRW	MC0616	25,40	Ch n° A906426 & R400728>, Alu

NISSAN

INTERSTAR (X70)

dCi 80; dCi 90; dCi 100; dCi 120; dCi 140; dCi 150	07.02-	BOSCH	MC0415	23,81/25,4	ABS-; ALU
dCi 80; dCi 90; dCi 100; dCi 120; dCi 140; dCi 150	07.02-	BOSCH	SV0001	SERVO	ABS-

OPEL

ARENA (THB)

2.5 D	03.98-08.01	BOSCH	MC0415	23,81/25,4	ABS-; ALU
2.5 D	03.98-08.01	BOSCH	SV0001	SERVO	ABS-

MOVANO (E9,F9,H9,J9,U9)

1.9 DTI; 2.2 DTI; 2.5 CDTI; 2.5 D; 2.5 DTI; 2.8 DTI; 3.0 DTI	07.98-	BOSCH	MC0415	23,81/25,4	ABS-; ALU
1.9 DTI; 2.2 DTI; 2.5 CDTI; 2.5 D; 2.5 DTI; 2.8 DTI; 3.0 DTI	07.98-	BOSCH	SV0001	SERVO	ABS-

RENAULT

TRAFIC (TXW, TXX)

2.5 D; 2.5 D 4x4	05.89-03.01	BOSCH	MC0415	23,81/25,4	ABS-; ALU
2.5 D; 2.5 D 4x4	05.89-03.01	BOSCH	SV0001	SERVO	ABS-



SYSTEM



RENAULT ../..

MASTER II (ED,FD,HD,JD/ND)

1.9 dCi 80; 1.9 dTi; 2.2 dCi 90; 2.5 D; 2.5 dCi; 2.5 dCi 120; 2.8 dTi	07.98-	BOSCH	MC0415	23,81/25,4	ABS-; ALU
1.9 dCi 80; 1.9 dTi; 2.2 dCi 90; 2.5 D; 2.5 dCi; 2.5 dCi 120; 2.8 dTi	07.98-	BOSCH	SV0001	SERVO	ABS-

MASTER III (ED,HD,FD,JD,U)

2.5 dCi; 2.5 dCi 100; 3.0 dCi 120; 3.0 dCi 140; 3.0 dCi 160	10.03-	BOSCH	MC0415	23,81/25,4	ABS-; ALU
2.5 dCi; 2.5 dCi 100; 3.0 dCi 120; 3.0 dCi 140; 3.0 dCi 160	10.03-	BOSCH	SV0001	SERVO	ABS-

RENAULT TRUCKS

SAVIEM

SB 2		BENDIX	MC0188	38,10	Simple circuit
SG 1	- 05.75	BENDIX	MC0187	28,50	Simple circuit
SG 2	01.65-	BENDIX	MC0187	28,50	Simple circuit avec Hydrovac
SG 2		BENDIX	MC0381	38,10	Double circuit
SG 3	- 05.75	BENDIX	MC0188	38,10	Simple circuit
SG 3		BENDIX	MC0391	38,10	Double circuit
SG 4	- 09.69	BENDIX	MC0188	38,10	Simple circuit
SG 4 T		BENDIX	MC0188	38,10	Simple circuit
SG 5		BENDIX	MC0188	38,10	Simple circuit
SG 5 C		BENDIX	MC0188	38,10	Simple circuit

B SERIE

B70; B90; B110; B120	01.85-12.96	BENDIX	MC0585	30,00	Double circuit
----------------------	-------------	--------	---------------	-------	----------------

MASCOTT

90; 110; 130; 140;	01.99-06.04		MC0235	25,40	Double circuit
120.35; 120.55; 120.65; 150.35; 150.55; 160.35; 160.55; 160.65;	05.04-		MC0235	25,40	Double circuit

VOLKSWAGEN

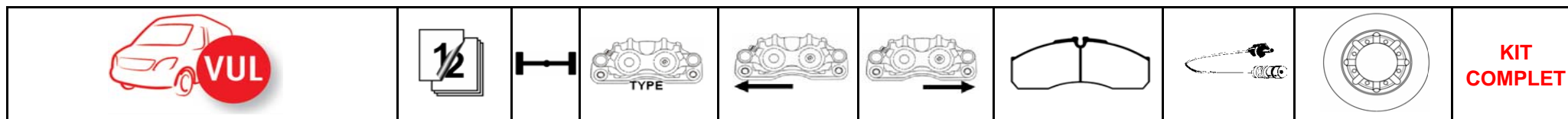
TRANSPORTER III

TRANSPORTER III	05.79-07.92		MC0619	23,81	
-----------------	-------------	--	---------------	-------	--

LT II

LT II 28-46 (2DX0AE, FE, 2DM)	04.96-03.06	BOSCH	MC0308	23,81	ABS+, Ch 2DZX004788>2DZ2011024
-------------------------------	-------------	-------	---------------	-------	--------------------------------

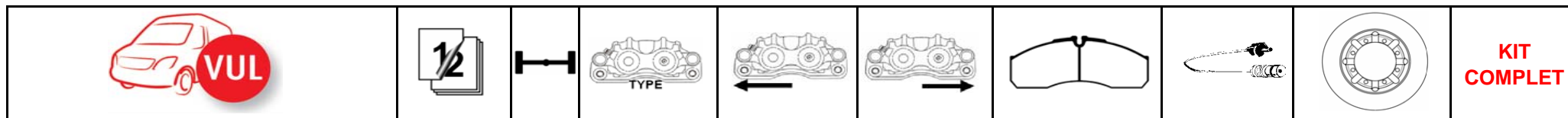
FREINAGE A DISQUE BRAKE DISC SYSTEM



CITROËN JUMPER

27; 31(230P, 230L) (ABS-)	09.01-03.02	AV	BREMBO PF 2.44/48	522.8142.45	522.8142.55	2391701 FVR1478			
27; 31(230P, 230L) (ABS-)	09.01-03.02	AR	BREMBO PF 1.46	522.8153.12	522.8153.22	2392101 FVR1480			
29; 33 (244) (ABS-)	04.02-06.06	AV	BREMBO PF 2.44/48	522.8142.45	522.8142.55	2391701 FVR1478		09.8931.20 92275103 DDF1170C	
29; 33 (244) (ABS-)	04.02-06.06	AR	BREMBO PF 1.46	522.8153.12	522.8153.22	2392101 FVR1480		08.8094.30 92116103 DDF1144C	
27; 31(230P, 230L) (ABS+)	09.01-03.02	AV	BREMBO PF 2.44/48	522.8142.46	522.8142.56	2391701 FVR1478			
27; 31(230P, 230L) (ABS+)	09.01-03.02	AR	BREMBO PF 1.46	522.8153.12	522.8153.22	2392101 FVR1480			
29; 33 (244) (ABS+)	04.02-06.06	AV	BREMBO PF 2.44/48	522.8142.46	522.8142.56	2391701 FVR1478		09.8931.20 92275103 DDF1170C	
29; 33 (244) (ABS+)	04.02-06.06	AR	BREMBO PF 1.46	522.8153.12	522.8153.22	2392101 FVR1480		08.8094.30 92116103 DDF1144C	
35 (230P, 230L, 244) (ABS-)	09.01-06.06	AV	BREMBO PF 2.46/52	522.8148.45	522.8148.55	2391901 FVR1479		09.8932.10 92116703 DDF768C	
35 (230P, 230L, 244) (ABS-)	09.01-06.06	AR	BREMBO PF 1.46	522.8153.12	522.8153.22	2392101 FVR1480		08.8094.40 92116203 DDF1145	
35 (230P, 230L, 244) (ABS+)	09.01-06.06	AV	BREMBO PF 2.46/52	522.8148.46	522.8148.56	2391901 FVR1479		09.8932.10 92116703 DDF768C	
35 (230P, 230L, 244) (ABS+)	09.01-06.06	AR	BREMBO PF 1.46	522.8153.12	522.8153.22	2392101 FVR1480		08.8094.40 92116203 DDF1145	

FREINAGE A DISQUE BRAKE DISC SYSTEM



DAF

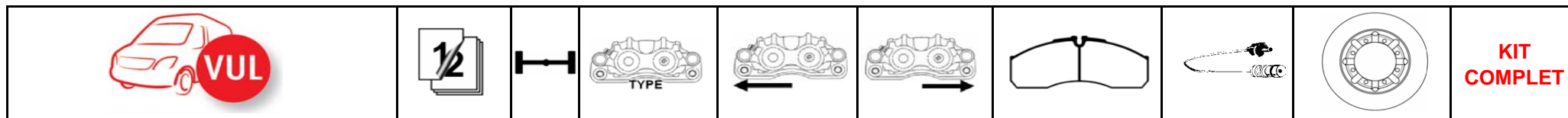
45 (6-8 t.)

FA600	01.87-12.01	AV	PERROT P 4.56	EFR039	EFR040	2901704 FCV503		09.5797.10 93084100 FCR101A	
FA800 CN	01.87-12.01	AV	PERROT P 4.56	EFR039	EFR040	2901704 FCV503		09.5797.10 93084100 FCR101A	
FA45.120, C6	01.91-12.01	AV	PERROT P 4.56	EFR039	EFR040	2901704 FCV503		09.5797.10 93084100 FCR101A	
FA45.130, C6, C8	01.91-12.01	AV	PERROT P 4.56	EFR039	EFR040	2901704 FCV503		09.5797.10 93084100 FCR101A	
FA45.150, C8	01.91-12.01	AV	PERROT P 4.56	EFR039	EFR040	2901704 FCV503		09.5797.10 93084100 FCR101A	
FA45.160, C8	01.91-12.01	AV	PERROT P 4.56	EFR039	EFR040	2901704 FCV503		09.5797.10 93084100 FCR101A	

45 (8-11 t.)

FA1000; FA1005	01.87-12.01	AV	PERROT P 4.65	EFR041	EFR042	2901704 FCV503		09.7323.10 93084200 FCR102A	
FA45.130, C9	01.91-12.01	AV	PERROT P 4.65	EFR041	EFR042	2901704 FCV503		09.7323.10 93084200 FCR102A	
FA45.150, C9	01.91-12.01	AV	PERROT P 4.65	EFR041	EFR042	2901704 FCV503		09.7323.10 93084200 FCR102A	
FA45.150, C11	01.91-12.01	AV	PERROT P 4.65	EFR041	EFR042	2901704 FCV503		09.7323.10 93084200 FCR102A	

FREINAGE A DISQUE BRAKE DISC SYSTEM



DAF../. 45 (8-11 t.)../.

FA45.160, C9	01.91-12.01	AV	PERROT P 4.65	EFR041	EFR042	2901704 FCV503		09.7323.10 93084200 FCR102A	
FA45.160, C11	01.91-12.01	AV	PERROT P 4.65	EFR041	EFR042	2901704 FCV503		09.7323.10 93084200 FCR102A	
FA45.180, C11	01.91-12.01	AV	PERROT P 4.65	EFR041	EFR042	2901704 FCV503		09.7323.10 93084200 FCR102A	
FA45.210, C11	01.91-12.01	AV	PERROT P 4.65	EFR041	EFR042	2901704 FCV503		09.7323.10 93084200 FCR102A	
FA45.512 (10 t)	01.91-12.01	AV	PERROT P 4.65	EFR041	EFR042	2901704 FCV503		09.7323.10 93084200 FCR102A	

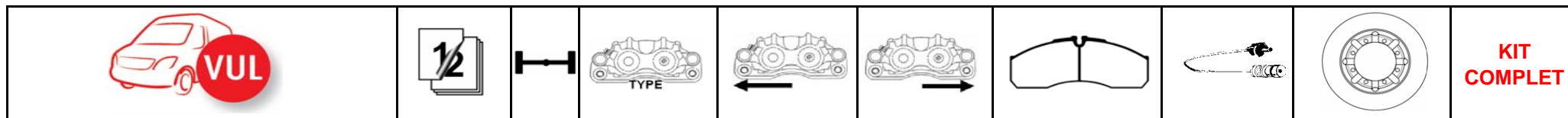
400 series

428-435 1375Kg	04.89-08.93	AV	AP LOCKHEED P 4.41	EFR061	EFR062	2035908 FVR829			
428-435 1450/1500/1600Kg	04.89-08.93	AV	AP LOCKHEED P 4.46	EFR063	EFR064	2090401 FVR836			

FIAT DUCATO

10Q; 14Q (230) (ABS-)	09.01-03.02	AV	BREMBO PF 2.44/48	522.8142.45	522.8142.55	2391701 FVR1478			
10Q; 14Q (230) (ABS-)	09.01-03.02	AR	BREMBO PF 1.46	522.8153.12	522.8153.22	2392101 FVR1480			
11Q; 15Q (244) (ABS-)	04.02-06.06	AV	BREMBO PF 2.44/48	522.8142.45	522.8142.55	2391701 FVR1478		09.8931.20 92275103 DDF1170C	

FREINAGE A DISQUE BRAKE DISC SYSTEM



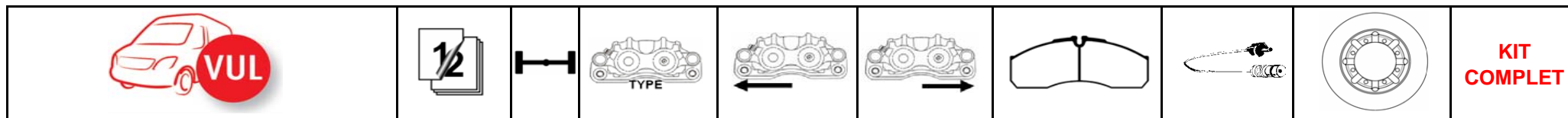
FIAT ../. DUCATO ../.

11Q; 15Q (244) (ABS-)	04.02-06.06	AR	BREMBO PF 1.46	522.8153.12	522.8153.22	2392101 FVR1480		08.8094.30 92116103 DDF1144C	
10Q; 14Q (230) (ABS+)	09.01-03.02	AV	BREMBO PF 2.44/48	522.8142.46	522.8142.56	2391701 FVR1478			
10Q; 14Q (230) (ABS+)	09.01-03.02	AR	BREMBO PF 1.46	522.8153.12	522.8153.22	2392101 FVR1480			
11Q; 15Q (244) (ABS+)	04.02-06.06	AV	BREMBO PF 2.44/48	522.8142.46	522.8142.56	2391701 FVR1478		09.8931.20 92275103 DDF1170C	
11Q; 15Q (244) (ABS+)	04.02-06.06	AR	BREMBO PF 1.46	522.8153.12	522.8153.22	2392101 FVR1480		08.8094.30 92116103 DDF1144C	
18Q (230&244) (ABS-)	09.01-06.06	AV	BREMBO PF 2.46/52	522.8148.45	522.8148.55	2391901 FVR1479		09.8932.10 92116703 DDF768C	
18Q (230&244) (ABS-)	09.01-06.06	AR	BREMBO PF 1.46	522.8153.12	522.8153.22	2392101 FVR1480		08.8094.40 92116203 DDF1145	
18Q (230&244) (ABS+)	09.01-06.06	AV	BREMBO PF 2.46/52	522.8148.46	522.8148.56	2391901 FVR1479		09.8932.10 92116703 DDF768C	
18Q (230&244) (ABS+)	09.01-06.06	AR	BREMBO PF 1.46	522.8153.12	522.8153.22	2392101 FVR1480		08.8094.40 92116203 DDF1145	

IRISBUS FR1

FR1 E; GT/T; T1; T2; TX-GTX	05.84-	AV	SEE PAM P 6.67	EFR003	EFR004	2904402 FCV1940		09.7956.10 93086200 FCR128A	
-----------------------------	--------	----	---------------------------	---------------	---------------	----------------------------	--	--	--

FREINAGE A DISQUE BRAKE DISC SYSTEM



IRISBUS ../. ILIADE

ILIADE; ILIADE TE	01.97-	AV	SEE PAM P 6.67	EFR003	EFR004	2904402 FCV1940		09.7956.10 93086200 FCR128A	
-------------------	--------	----	-------------------	---------------	---------------	----------------------------	--	--	--

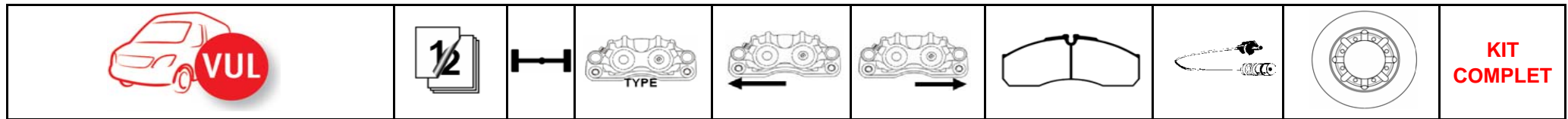
ISUZU NKR - NPR

NPR 3,5T	01.02-	AV	AKEBONO PF 2.54	EFR083	EFR084	PF1235 FCV5000B		DF6392	
NPR NQR 7,5T	01.02-	AV	AKEBONO PF	EFRXXX	EFRXXX	PF1236 FCV1853		DF6393	
NPR NQR 7,5T	01.02-	AR	AKEBONO PF	EFRXXX	EFRXXX	PF1580		DFXXX	

IVECO DAILY 30-35

30.8	-12.95	AV	BREMBO P 4.42	520.4910.84	520.4910.85	507.4146.49 2903701 FVR713		08.5374.10 93084400 DDF254-1	
30.8 Restyling-New Daily (96)	01.96-12.98	AV	BREMBO P 4.42	520.4910.84	520.4910.85	507.4146.86 2903701 FVR713		08.5374.10 93084400 DDF254-1	
30.8 Duty	-08.86	AV	BREMBO P 4.42	520.4910.82	520.4910.83	507.4146.61 2118801 FVR511		08.3907.10 93019400 DDF089-1	
30.8 Duty	09.86-12.88	AV	BREMBO P 4.42	520.4910.82	520.4910.83	507.4146.51 2118801 FVR511		08.3907.10 93019400 DDF089-1	
30.8 Duty	01.89-12.95	AV	BREMBO P 4.42	520.4910.82	520.4910.83	507.4146.48 2904101 FVR655		08.3907.10 93019400 DDF089-1	

FREINAGE A DISQUE BRAKE DISC SYSTEM

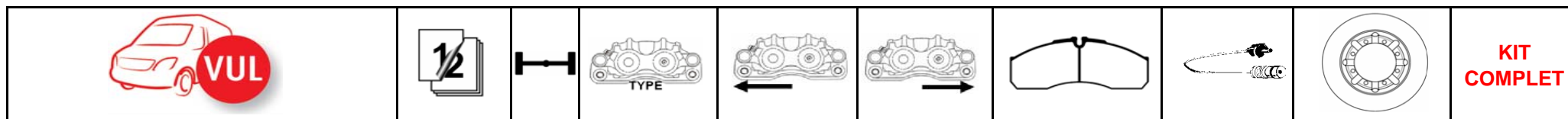


IVECO ..J..

DAILY 30-35 ..J..

30.8 Duty	01.96-12.98	AV	BREMBO P 4.42	520.4910.82	520.4910.83	507.4146.85 2914001 FVR1353		08.3907.10 93019400 DDF089-1	
30.10 Turbodayly (96)	-12.95	AV	BREMBO P 4.42	520.4910.84	520.4910.85	507.4146.49 2903701 FVR713		08.5374.10 93084400 DDF254-1	
30.10 Turbodayly (96)	01.96-12.98	AV	BREMBO P 4.42	520.4910.84	520.4910.85	507.4146.86 2903701 FVR713		08.5374.10 93084400 DDF254-1	
35.8; 35.10 Restyling (1 ENTREE)	01.78- 12.89	AV	AP LOCKHEED P 4.41	EFR130	EFR131	2035907 FVR839		08.3907.10 93019400 DDF089-1	
35.8; 35.10 Restyling (2 ENTREES)	01.78- 12.89	AV	AP LOCKHEED P 4.41	EFR132	EFR133	2035907 FVR839		08.3907.10 93019400 DDF089-1	
35.8; 35.10 Restyling -New Daily (96)	-08.86	AV	BREMBO P 4.42	520.4910.82	520.4910.83	507.4146.61 2118801 FVR511		08.3907.10 93019400 DDF089-1	
35.8; 35.10 Restyling -New Daily (96)	09.86-12.88	AV	BREMBO P 4.42	520.4910.82	520.4910.83	507.4146.51 2118801 FVR511		08.3907.10 93019400 DDF089-1	
35.8; 35.10 Restyling -New Daily (96)	01.89-12.95	AV	BREMBO P 4.42	520.4910.82	520.4910.83	507.4146.48 2904101 FVR655		08.3907.10 93019400 DDF089-1	
35.8; 35.10 Restyling -New Daily (96)	01.96-12.98	AV	BREMBO P 4.42	520.4910.82	520.4910.83	507.4146.85 2914001 FVR1353		08.3907.10 93019400 DDF089-1	
35-10T; 35-12T	01.90-07.98	AV	PERROT P 4.44	EFR043	EFR044	2913801 FVR1351		08.3907.10 93019400 DDF089-1	

FREINAGE A DISQUE BRAKE DISC SYSTEM



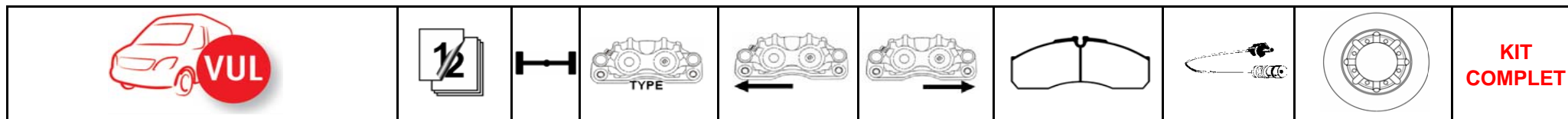
IVECO ..J.. DAILY (96)

35.8; 35.10; 35.12	01.96-05.04	AV	BREMBO PF 2.44	522.7773.28	522.7773.29	507.5944.11 2912112 FVR1102	507.4656.94 98024800	08.5959.10 93095100 FCR139A	
35.8; 35.10; 35.12	01.96-05.04	AR	BREMBO PF 2.44	522.7775.28	522.7775.29	507.5944.11 2912112 FVR1102	507.4656.94 98024800	08.5952.10 93089600 FCR140A	HBK2002 ou/or HBK2002+
49.10; 49.12	01.96-05.04	AV	BREMBO PF 2.44	522.7773.28	522.7773.29	507.5944.11 2912112 FVR1102	507.4656.94 98024800	08.5959.10 93095100 FCR139A	
49.10; 49.12	01.96-05.04	AR	BREMBO PF 2.44	522.7775.28	522.7775.29	507.5944.11 2912112 FVR1102	507.4656.94 98024800	08.5952.10 93089600 FCR140A	HBK2002 ou/or HBK2002+

DAILY 40 - 45 - 49

40.8; 40.10 New Daily	-08.86	AV	BREMBO P 4.42	520.4910.82	520.4910.83	507.4146.61 2118801 FVR511		08.3907.10 93019400 DDF089-1	
40.8; 40.10 New Daily	09.86-12.88	AV	BREMBO P 4.42	520.4910.82	520.4910.83	507.4146.51 2118801 FVR511		08.3907.10 93019400 DDF089-1	
40.8; 40.10 New Daily	01.89-12.95	AV	BREMBO P 4.42	520.4910.82	520.4910.83	507.4146.48 2904101 FVR655		08.3907.10 93019400 DDF089-1	
40.8; 40.10 New Daily	01.96-12.98	AV	BREMBO P 4.42	520.4910.82	520.4910.83	507.4146.85 2914001 FVR1353		08.3907.10 93019400 DDF089-1	
40-10TW; 49-10T; 49-12T	01.90-07.98	AV	PERROT P 4.44	EFR043	EFR044	2913801 FVR1351		08.5079.10 93042801 FCR104A	
45.10; 45.12; 49.10; 49.12	-12.96	AV	BREMBO P 4.44	520.5150.11	520.5150.21	507.4146.87 2913801 FVR1351		08.5079.10 93042801 FCR104A	

FREINAGE A DISQUE BRAKE DISC SYSTEM



IVECO ..J..

DAILY 59-12 Turbo Intercooler

59-12 Turbo Intercooler	01.92-12.98	AV	PERROT P 4.50	EFR045	EFR046	2910701 FVR1350		09.6957.20 93084500 FCR133A	
59-12 Turbo Intercooler	01.92-12.98	AV	BREMBO P 4.50	520.9576.10	520.9576.20	2910701 FVR1350		09.6957.20 93084500 FCR133A	

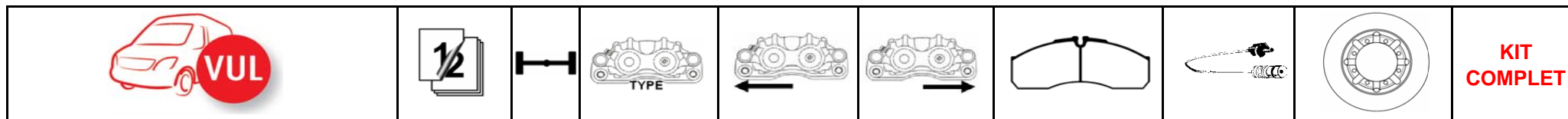
DAILY Série 29 L

29L9; 29L10; 29L11; 29L12; 29L13; 29L14;	01.96-12.03	AV	BREMBO PF 2.42	522.7220.01	522.7220.02	507.5444.32 2912111	507.4656.94 98024800	08.7219.10 93104600 FCR194A	
29L9; 29L10; 29L11; 29L12; 29L13; 29L14; (ABS+)	01.96-12.03	AR	BREMBO PFC 1.52	522.7270.52	522.7270.62	507.7273.12 2912303 FVR1405	507.9308.63	08.7300.20 93104800 FCR196A	
29L9; 29L10; 29L11; 29L12; 29L13; 29L14; (ABS-)	01.96-12.03	AR	BREMBO PFC 1.52	522.7270.52	522.7270.62	507.7273.12 2912303 FVR1405	507.9308.63	08.7300.10 93104700 FCR195A	
29L9; 29L10; 29L11; 29L12; 29L13; 29L14;	01.04-06.06	AV	BREMBO PF 2.44	522.9272.01	522.9272.02	507.5944.32 2912111 FVR1315	507.4656.94 98024800	08.7219.10 93104600 FCR194A	
29L9; 29L10; 29L11; 29L12; 29L13; 29L14; (ABS+)	01.04-06.06	AR	BREMBO PFC 1.52	522.7270.52	522.7270.62	507.7273.12 2912303 FVR1405	507.9308.63	08.7300.20 93104800 FCR196A	
29L9; 29L10; 29L11; 29L12; 29L13; 29L14; (ABS-)	01.04-06.06	AR	BREMBO PFC 1.52	522.7270.52	522.7270.62	507.7273.12 2912303 FVR1405	507.9308.63	08.7300.10 93104700 FCR195A	

DAILY Série S 35

35S9; 35S10; 35S11; 35S13; 35S14; 35S17; 40S17;	01.96-12.03	AV	BREMBO PF 2.42	522.7220.01	522.7220.02	507.5444.32 2912111	507.4656.94 98024800	08.7219.10 93104600 FCR194A	
--	-------------	----	---------------------------	--------------------	--------------------	--------------------------------	---------------------------------	--	--

FREINAGE A DISQUE BRAKE DISC SYSTEM



IVECO ..J..

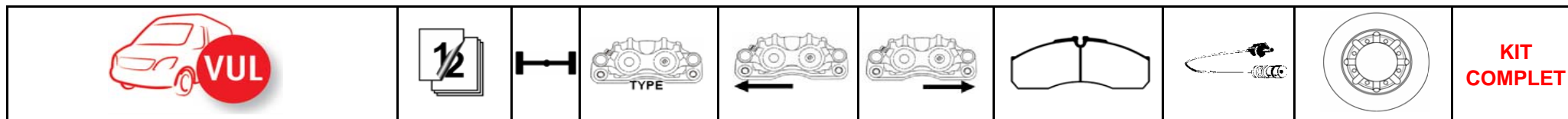
DAILY Série S 35 ..J..

35S9; 35S10; 35S11; 35S13; 35S14; 35S17; 40S17; (ABS+)	01.96-12.03	AR	BREMBO PFC 1.52	522.7270.52	522.7270.62	507.7273.12 2912303 FVR1405	507.9308.63	08.7300.20 93104800 FCR196A	
35S9; 35S10; 35S11; 35S13; 35S14; 35S17; 40S17; (ABS-)	01.96-12.03	AR	BREMBO PFC 1.52	522.7270.52	522.7270.62	507.7273.12 2912303 FVR1405	507.9308.63	08.7300.10 93104700 FCR195A	
35S9; 35S10; 35S11; 35S13; 35S14; 35S17; 40S17;	01.04-04.06	AV	BREMBO PF 2.44	522.9272.01	522.9272.02	507.5944.32 2912111 FVR1315	507.4656.94 98024800	08.7219.10 93104600 FCR194A	
35S9; 35S10; 35S11; 35S13; 35S14; 35S17; 40S17; (ABS+)	01.04-04.06	AR	BREMBO PFC 1.52	522.7270.52	522.7270.62	507.7273.12 2912303 FVR1405	507.9308.63	08.7300.20 93104800 FCR196A	
35S9; 35S10; 35S11; 35S13; 35S14; 35S17; 40S17; (ABS-)	01.04-04.06	AR	BREMBO PFC 1.52	522.7270.52	522.7270.62	507.7273.12 2912303 FVR1405	507.9308.63	08.7300.10 93104700 FCR195A	

DAILY Série C

35C9; 35C10; 35C11; 35C13; 35C14; 35C17; 35C18	01.96-05.04	AV	BREMBO PF 2.44	522.7773.28	522.7773.29	507.5944.11 2912112 FVR1102	507.4656.94 98024800	08.5959.10 93095100 FCR139A	
35C9; 35C10; 35C11; 35C13; 35C14; 35C17; 35C18	01.96-05.04	AR	BREMBO PF 2.44	522.7775.28	522.7775.29	507.5944.11 2912112 FVR1102	507.4656.94 98024800	08.5952.10 93089600 FCR140A	HBK2002 ou/or HBK2002+
35C9; 35C10; 35C11; 35C13; 35C14; 35C17; 35C18	06.04-06.06	AV	BREMBO PF 2.44	522.7773.28	522.7773.29	507.5944.11 2912112 FVR1102	507.4656.94 98024800	08.9459.20 93175400 FCR313A	
35C9; 35C10; 35C11; 35C13; 35C14; 35C17; 35C18	06.04-06.06	AR	BREMBO PF 2.44	522.7775.28	522.7775.29	507.5944.11 2912112 FVR1102	507.4656.94 98024800	08.5952.10 93089600 FCR140A	HBK2002 ou/or HBK2002+
40C10; 40C13; 40C14; 40C15; 40C17;	01.96-05.04	AV	BREMBO PF 2.44	522.7773.28	522.7773.29	507.5944.11 2912112 FVR1102	507.4656.94 98024800	08.5959.10 93095100 FCR139A	

FREINAGE A DISQUE BRAKE DISC SYSTEM



IVECO ..J..

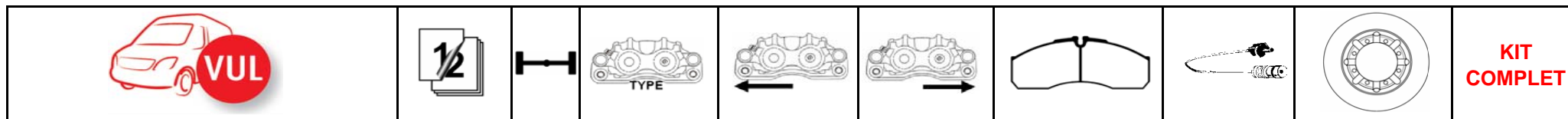
DAILY Série C ..J..

40C10; 40C13; 40C14; 40C15; 40C17;	01.96-05.04	AR	BREMBO PF 2.44	522.7775.28	522.7775.29	507.5944.11 2912112 FVR1102	507.4656.94 98024800	08.5952.10 93089600 FCR140A	HBK2002 ou/or HBK2002+
40C10; 40C13; 40C14; 40C15; 40C17;	06.04-06.06	AV	BREMBO PF 2.44	522.7773.28	522.7773.29	507.5944.11 2912112 FVR1102	507.4656.94 98024800	08.9459.20 93175400 FCR313A	
40C10; 40C13; 40C14; 40C15; 40C17;	06.04-06.06	AR	BREMBO PF 2.44	522.7775.28	522.7775.29	507.5944.11 2912112 FVR1102	507.4656.94 98024800	08.5952.10 93089600 FCR140A	HBK2002 ou/or HBK2002+
50C11; 50C13; 50C14; 50C15; 50C17	01.96-05.04	AV	BREMBO PF 2.44	522.7773.28	522.7773.29	507.5944.11 2912112 FVR1102	507.4656.94 98024800	08.5959.10 93095100 FCR139A	
50C11; 50C13; 50C14; 50C15; 50C17	01.96-05.04	AR	BREMBO PF 2.44	522.7775.28	522.7775.29	507.5944.11 2912112 FVR1102	507.4656.94 98024800	08.5952.10 93089600 FCR140A	HBK2002 ou/or HBK2002+
50C11; 50C13; 50C14; 50C15; 50C17	06.04-06.06	AV	BREMBO PF 2.44	522.7773.28	522.7773.29	507.5944.11 2912112 FVR1102	507.4656.94 98024800	08.9459.20 93175400 FCR313A	
50C11; 50C13; 50C14; 50C15; 50C17	06.04-06.06	AR	BREMBO PF 2.44	522.7775.28	522.7775.29	507.5944.11 2912112 FVR1102	507.4656.94 98024800	08.5952.10 93089600 FCR140A	HBK2002 ou/or HBK2002+
65C11; 65C13; 65C15; 65C17;	01.96-04.06	AV	BREMBO PF 2.52	522.7301.28	522.7301.29	507.7304.18 2916002 FVR1390	507.4656.94 98024800	09.7723.10 93127200 FCR235A	
65C11; 65C13; 65C15; 65C17;	01.96-04.06	AR	BREMBO PF 2.46	522.7306.28	522.7306.29	507.5944.11 2912112 FVR1102	507.4656.94 98024800	08.7772.10 93127300 FCR236A	

DAILY 2006 Serie L & S

29L13; 29L13D; 29L14; 29L15 V; 33S11; 33S12; 33S13; 33S14; 33S15; 33S16;	06.06-	AV	BREMBO PF 2.48	522.9700.10	522.9700.20	507.9703.10 2922901 FVR4036	507.9308.63 98040700	09.9758.10 92155900 FCR314A	KDC1001
---	--------	----	---------------------------	--------------------	--------------------	--	---------------------------------	--	----------------

FREINAGE A DISQUE BRAKE DISC SYSTEM

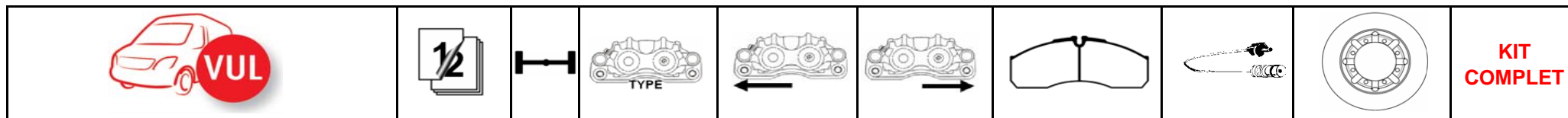


IVECO ..J..

DAILY 2006 Serie L & S ..J..

29L13; 29L13D; 29L14; 29L15 V; 33S11; 33S12; 33S13; 33S14; 33S15; 33S16; (ABS+)	06.06-	AR	BREMBO PFC 1.52	522.7270.52	522.7270.62	507.7273.16 2912303 FVR4140	507.9308.53 98040900	08.9759.20 93177500 FCR316A	
29L13; 29L13D; 29L14; 29L15 V; 33S11; 33S12; 33S13; 33S14; 33S15; 33S16; (ABS-)	06.06-	AR	BREMBO PFC 1.52	522.7270.52	522.7270.62	507.7273.16 2912303 FVR4140	507.9308.53 98040900	08.9759.10 93229100 FCR315A	
35S/E; 35S10; 35S11; 35S11 /P; 35S11 D; 35S12; 35S13; 35S13 /P; 35S13 D; 35S14; 35S14 /P; 35S14 D; 35S14 D/P; 35S14 G; 35S14 G/P; 35S15; 35S16; 35S17; 35S17 /P; 35S17 D; 35S17 W; 35S17 WD; 35S18; 35S18W; 35S21; 40S14	06.06-	AV	BREMBO PF 2.48	522.9700.10	522.9700.20	507.9703.10 2922901 FVR4036	507.9308.63 98040700	09.9758.10 92155900 FCR314A	KDC1001
35S/E; 35S10; 35S11; 35S11 /P; 35S11 D; 35S12; 35S13; 35S13 /P; 35S13 D; 35S14; 35S14 /P; 35S14 D; 35S14 D/P; 35S14 G; 35S14 G/P; 35S15; 35S16; 35S17; 35S17 /P; 35S17 D; 35S17 W; 35S17 WD; 35S18; 35S18W; 35S21; 40S14 (ABS+)	06.06-	AR	BREMBO PFC 1.52	522.7270.52	522.7270.62	507.7273.16 2912303 FVR4140	507.9308.53 98040900	08.9759.20 93177500 FCR316A	
35S/E; 35S10; 35S11; 35S11 /P; 35S11 D; 35S12; 35S13; 35S13 /P; 35S13 D; 35S14; 35S14 /P; 35S14 D; 35S14 D/P; 35S14 G; 35S14 G/P; 35S15; 35S16; 35S17; 35S17 /P; 35S17 D; 35S17 W; 35S17 WD; 35S18; 35S18W; 35S21; 40S14 (ABS-)	06.06-	AR	BREMBO PFC 1.52	522.7270.52	522.7270.62	507.7273.16 2912303 FVR4140	507.9308.53 98040900	08.9759.10 93229100 FCR315A	
55S17 W; 55S17 WD; 55S18W;	06.06-	AV	BREMBO PF 2.48	522.9700.10	522.9700.20	507.9703.10 2922901 FVR4036	507.9308.63 98040700	09.9758.10 92155900 FCR314A	KDC1001

FREINAGE A DISQUE BRAKE DISC SYSTEM



IVECO ..J..

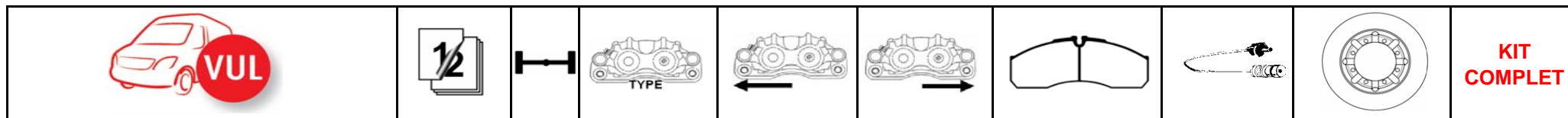
DAILY 2006 Serie L & S ..J..

55S17 W; 55S17 WD; 55S18W; (ABS+)	06.06-	AR	BREMBO PFC 1.52	522.7270.52	522.7270.62	507.7273.16 2912303 FVR4140	507.9308.53 98040900	08.9759.20 93177500 FCR316A	
55S17 W; 55S17 WD; 55S18W; (ABS-)	06.06-	AR	BREMBO PFC 1.52	522.7270.52	522.7270.62	507.7273.16 2912303 FVR4140	507.9308.53 98040900	08.9759.10 93229100 FCR315A	

DAILY 2006 Serie C

35C10; 35C11; 35C11D; 35C12; 35C13; 35C13 /P; 35C13D; 35C14; 35C14 /P; 35C14 G; 35C14 G/P; 35C14 GD; 35C15; 35C15D; 35C15L V; 35C16; 35C17; 35C17 /P; 35C17D; 35C18; 35C21;	06.06-	AV	BREMBO PF 2.48	522.9700.10	522.9700.20	507.9703.10 2922901 FVR4036	507.9308.63 98040700	09.9760.10 92155700 FCR317A	KDC1000
35C10; 35C11; 35C11D; 35C12; 35C13; 35C13 /P; 35C13D; 35C14; 35C14 /P; 35C14 G; 35C14 G/P; 35C14 GD; 35C15; 35C15D; 35C15L V; 35C16; 35C17; 35C17 /P; 35C17D; 35C18; 35C21; (ABS+)	06.06-	AR	BREMBO PFC 1.60	522.9721.00	522.9721.01	507.9724.10 2923201 FVR4037	507.9308.66	09.9761.60 92171700 FCR321A	KDC3001
35C10; 35C11; 35C11D; 35C12; 35C13; 35C13 /P; 35C13D; 35C14; 35C14 /P; 35C14 G; 35C14 G/P; 35C14 GD; 35C15; 35C15D; 35C15L V; 35C16; 35C17; 35C17 /P; 35C17D; 35C18; 35C21; (ABS-)	06.06-	AR	BREMBO PFC 1.60	522.9721.00	522.9721.01	507.9724.10 2923201 FVR4037	507.9308.66	09.9761.10 93175300 FCR320A	KDC3000
40C10; 40C11; 40C11 D; 40C12; 40C13; 40C13 /P; 40C14; 40C14 /P; 40C14 G; 40C14 G/P; 40C15; 40C15L V; 40C17; 40C17 /P; 40C18; 40C21; 45C/E; 45C14; 45C14 /P; 45C15; 45C17; 45C17 /P; 45C18; 45C18 /P; 45C18 D; 45C18 D/P; 45C21;	06.06-	AV	BREMBO PF 2.48	522.9700.10	522.9700.20	507.9703.10 2922901 FVR4036	507.9308.63 98040700	09.9760.10 92155700 FCR317A	KDC1000

FREINAGE A DISQUE BRAKE DISC SYSTEM

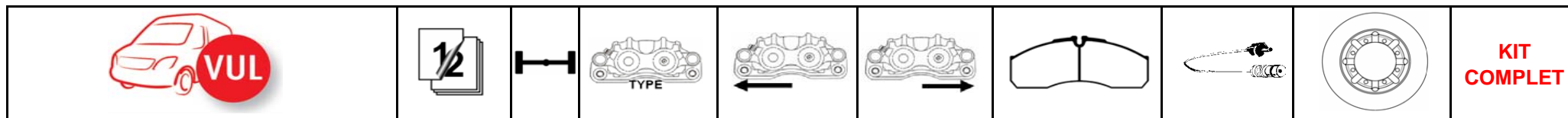


IVECO ..J..

DAILY 2006 Serie C ..J..

40C10; 40C11; 40C11 D; 40C12; 40C13; 40C13 /P; 40C14; 40C14 /P; 40C14 G; 40C14 G/P; 40C15; 40C15L V; 40C17; 40C17 /P; 40C18; 40C21; 45C/E; 45C14; 45C14 /P; 45C15; 45C17; 45C17 /P; 45C18; 45C18 /P; 45C18 D; 45C18 D/P; 45C21; (ABS+)	06.06-	AR	BREMBO PFC 1.60	522.9721.00	522.9721.01	507.9724.10 2923201 FVR4037	507.9308.66	09.9761.60 92171700 FCR321A	KDC3001
40C10; 40C11; 40C11 D; 40C12; 40C13; 40C13 /P; 40C14; 40C14 /P; 40C14 G; 40C14 G/P; 40C15; 40C15L V; 40C17; 40C17 /P; 40C18; 40C21; 45C/E; 45C14; 45C14 /P; 45C15; 45C17; 45C17 /P; 45C18; 45C18 /P; 45C18 D; 45C18 D/P; 45C21; (ABS-)	06.06-	AR	BREMBO PFC 1.60	522.9721.00	522.9721.01	507.9724.10 2923201 FVR4037	507.9308.66	09.9761.10 93175300 FCR320A	KDC3000
50C/E; 50C14; 50C14 /P; 50C14 G; 50C14 G/P; 50C14 GD; 50C14 GD/; 50C15; 50C15L V; 50C17; 50C17 /P; 50C18; 50C21; 55C16; 55C17;	06.06-	AV	BREMBO PF 2.48	522.9700.10	522.9700.20	507.9703.10 2922901 FVR4036	507.9308.63 98040700	09.9760.10 92155700 FCR317A	KDC1000
50C/E; 50C14; 50C14 /P; 50C14 G; 50C14 G/P; 50C14 GD; 50C14 GD/; 50C15; 50C15L V; 50C17; 50C17 /P; 50C18; 50C21; 55C16; 55C17; (ABS+)	06.06-	AR	BREMBO PFC 1.60	522.9721.00	522.9721.01	507.9724.10 2923201 FVR4037	507.9308.66	09.9761.60 92171700 FCR321A	KDC3001
50C/E; 50C14; 50C14 /P; 50C14 G; 50C14 G/P; 50C14 GD; 50C14 GD/; 50C15; 50C15L V; 50C17; 50C17 /P; 50C18; 50C21; 55C16; 55C17; (ABS-)	06.06-	AR	BREMBO PFC 1.60	522.9721.00	522.9721.01	507.9724.10 2923201 FVR4037	507.9308.66	09.9761.10 93175300 FCR320A	KDC3000

FREINAGE A DISQUE BRAKE DISC SYSTEM



IVECO ..J..

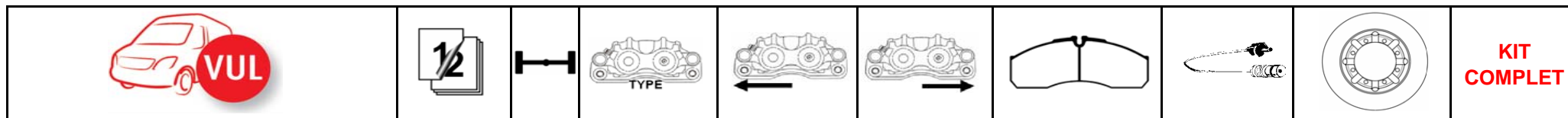
DAILY 2006 Serie C ..J..

60C14; 60C14 /P; 60C15; 60C15 /P; 60C15 D; 60C15 D/P; 60C17; 60C17 /P; 60C18; 60C21; 65C14; 65C14 /P; 65C14 G; 65C14 G/P; 65C14 GD; 65C14 GD/; 65C15; 65C15 /P; 65C15 D; 65C15 D/P; 65C17; 65C17 /P; 65C18; 65C21;	06.06-	AV	BREMBO PF 2.60	522.9788.10	522.9788.20	507.5901.30 2912204 FCV1126	507.4656.05 98042200	09.9762.10 93177603 FCR329A	
60C14; 60C14 /P; 60C15; 60C15 /P; 60C15 D; 60C15 D/P; 60C17; 60C17 /P; 60C18; 60C21; 65C14; 65C14 /P; 65C14 G; 65C14 G/P; 65C14 GD; 65C14 GD/; 65C15; 65C15 /P; 65C15 D; 65C15 D/P; 65C17; 65C17 /P; 65C18; 65C21;	06.06-	AR	BREMBO PF 2.48	522.9782.10	522.9782.20	507.9786.10 2923101 FVR4039	507.9308.63 98040700	09.9763.10 93177703 FCR332A	
70C14; 70C14 /P; 70C15; 70C16; 70C17; 70C17 /P; 70C18; 70C21;	06.06-	AV	BREMBO PF 2.60	522.9788.10	522.9788.20	507.5901.30 2912204 FCV1126	507.4656.05 98042200	09.9762.10 93177603 FCR329A	
70C14; 70C14 /P; 70C15; 70C16; 70C17; 70C17 /P; 70C18; 70C21;	06.06-	AR	BREMBO PF 2.48	522.9782.10	522.9782.20	507.9786.10 2923101 FVR4039	507.9308.63 98040700	09.9763.10 93177703 FCR332A	

EUROCARGO 60

60; 65; 75	01.91-02.07	AV	BREMBO PF 2.60	522.5760.08	522.5760.09	507.5901.21 2912204 FCV1126	507.4656.94 98024800	09.6813.20 93084800 FCR105A	
60; 65; 75 (ABS+)	01.91-02.07	AR	BREMBO PFC 2.60	522.5770.16	522.5770.26	507.5901.21 2912204 FCV1126	507.4656.94 98024800	09.6813.60 93084800 FCR322A	
60; 65; 75 (ABS-)	01.91-02.07	AR	BREMBO PFC 2.60	522.5770.16	522.5770.26	507.5901.21 2912204 FCV1126	507.4656.94 98024800	09.6813.20 93084800 FCR105A	

FREINAGE A DISQUE BRAKE DISC SYSTEM



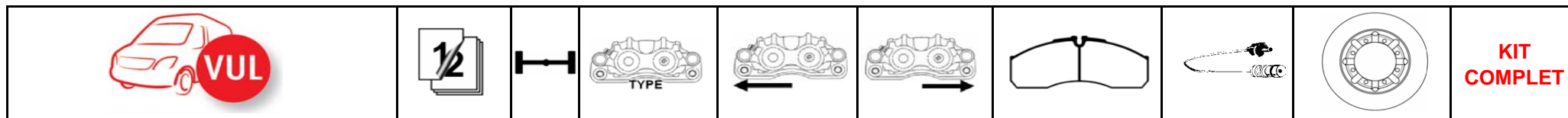
IVECO ..J.. EUROCARGO 80

80; 100	01.91-02.07	AV	BREMBO PF 2.68	522.5660.08	522.5660.09	507.5664.31 2906705 FCV733	507.4656.94 98024800	09.6763.20 93084900 FCR106A	
80; 100 (ABS+)	01.91-02.07	AR	BREMBO PFC 2.68	522.5670.08	522.5670.09	507.5664.31 2906705 FCV733	507.4656.94 98024800	09.6763.60 93084900 FCR341A	
80; 100 (ABS-)	01.91-02.07	AR	BREMBO PFC 2.68	522.5670.08	522.5670.09	507.5664.31 2906705 FCV733	507.4656.94 98024800	09.6763.20 93084900 FCR106A	

EUROCARGO

60E16; 60E16P; 65E16; 65E16P; 75E16; 75E16P; 75E19; 75E19P; 75E21; 75E21P; 80E19; 80E19P; 80E21; 80E21FP; 80E21FP; 80E21P; 80E22; 80E22FP; 80EL16; 80EL16P; 80EL19; 80EL19P; 80EL21; 80EL21P;	03.07-	AV	BREMBO PF 2.60	522.9800.08	522.9800.09	507.9814.21 2925601 G1020915 FCV4254	507.9308.62	09.A315.10 93221300 FCR338A	
60E16; 60E16P; 65E16; 65E16P; 75E16; 75E16P; 75E19; 75E19P; 75E21; 75E21P; 80E19; 80E19P; 80E21; 80E21FP; 80E21FP; 80E21P; 80E22; 80E22FP; 80EL16; 80EL16P; 80EL19; 80EL19P; 80EL21; 80EL21P;	03.07-	AR	BREMBO PFC 2.60	522.9801.08	522.9801.09	507.9814.21 2925601 G1020915 FCV4254	507.9308.62	09.A315.60 93221200 FCR342A	
90E19; 90E19P; 90E21; 90E21P; 90E22; 90E22FP; 90E22P; 100E19; 100E19P; 100E21; 100E21FP; 100E21P; 100E22; 100E22FP; 100E22P; 100E25FP;	03.07-	AV	BREMBO PF 2.68	522.9802.08	522.9802.09	507.9814.11 2925601 G1020915 FCV4254	507.9308.62	09.A315.10 93221300 FCR338A	
90E19; 90E19P; 90E21; 90E21P; 90E22; 90E22FP; 90E22P; 100E19; 100E19P; 100E21; 100E21FP; 100E21P; 100E22; 100E22FP; 100E22P; 100E25FP;	03.07-	AR	BREMBO PFC 2.68	522.9803.08	522.9803.09	507.9814.11 2925601 G1020915 FCV4254	507.9308.62	09.A315.60 93221200 FCR342A	

FREINAGE A DISQUE BRAKE DISC SYSTEM



LDV CONVOY

428-435 1375Kg	09.93-	AV	AP LOCKHEED P 4.41	EFR061	EFR062	2035908 FVR829			
428-435 1450/1500/1600Kg	09.93-	AV	AP LOCKHEED P 4.46	EFR063	EFR064	2090401 FVR836			

MERCEDES

MB100 D

100	02.88-04.96	AV	BENDIX PF 2.48	EFR067	EFR068	2157302 FVR941			
-----	-------------	----	-------------------	---------------	---------------	---------------------------------	--	--	--

T1 207D - 310D (étriers simple circuit)

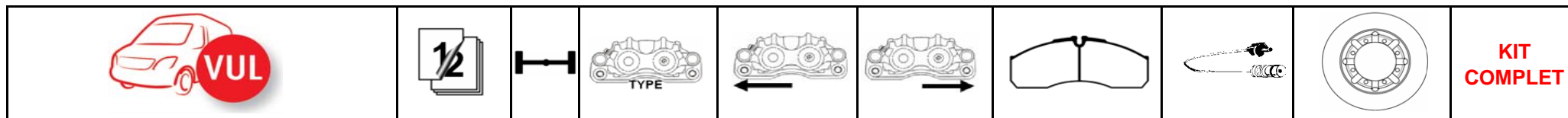
207D - 310D	05.77-02.96	AV	PERROT P 4.44	EFR047	EFR048	2078401 FVR239	98021302	08.3959.20 93012400 FCR116A	
207D - 310D	05.77-02.96	AV	ATE/TEVES P 4.44	EFR053	EFR054	2078401 FVR239	98021302	08.3959.20 93012400 FCR116A	

T1 207D - 310D (étriers double circuit)

207D - 310D	05.77-02.96	AV	PERROT P 4.44	EFR049	EFR050	2078401 FVR239	98021302	08.3959.20 93012400 FCR116A	
207D - 310D	05.77-02.96	AV	ATE/TEVES P 4.44	EFR055	EFR056	2078401 FVR239	98021302	08.3959.20 93012400 FCR116A	

T1 407D - 510 (étriers simple circuit)

407D - 510 -Ch.:A025460	05.77-	AV	PERROT P 4.44	EFR047	EFR048	2078401 FVR239	98021302	08.3959.20 93012400 FCR116A	
407D - 510 -Ch.:A025460	05.77-	AV	ATE/TEVES P 4.44	EFR053	EFR054	2078401 FVR239	98021302	08.3959.20 93012400 FCR116A	



MERCEDES ../.

T1 407D - 510 (étriers double circuit)

407D - 510 -Ch.:A025460	05.77-	AV	PERROT P 4.44	EFR049	EFR050	2078401 FVR239	98021302	08.3959.20 93012400 FCR116A	
407D - 510 -Ch.:A025460	05.77-	AV	ATE/TEVES P 4.44	EFR055	EFR056	2078401 FVR239	98021302	08.3959.20 93012400 FCR116A	

T1 407D - 510 (étriers simple circuit)

407D - 510 Ch.:A025461-	-02.96	AV	PERROT P 4.44	EFR047	EFR048	2078401 FVR239	98021302	08.6923.20 93054600 FCR117A	
407D - 510 Ch.:A025461-	-02.96	AV	ATE/TEVES P 4.44	EFR053	EFR054	2078401 FVR239	98021302	08.6923.20 93054600 FCR117A	

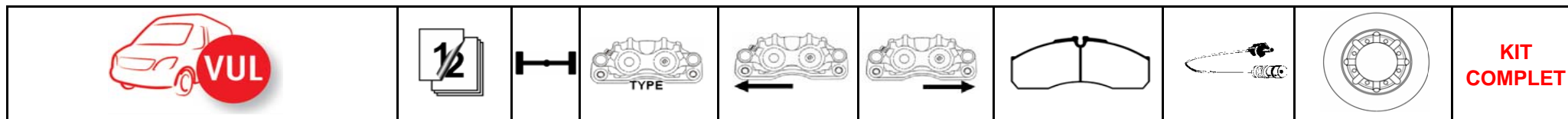
T1 407D - 510 (étriers double circuit)

407D - 510 Ch.:A025461-	-02.96	AV	PERROT P 4.44	EFR049	EFR050	2078401 FVR239	98021302	08.6923.20 93054600 FCR117A	
407D - 510 Ch.:A025461- (ETRIER 2 ENTREES)	-02.96	AV	ATE/TEVES P 4.44	EFR055	EFR056	2078401 FVR239	98021302	08.6923.20 93054600 FCR117A	

SPRINTER (904)

408CDI; 408D; 410D; 411CDI; 412D; 413CDI; 414; 416CDI -Ch.: S482213 / Y422059	02.96-12.01	AV	PERROT PF 2.44 V1	EFR051	EFR052	2915301 FVR1879	98031700		
408CDI; 408D; 410D; 411CDI; 412D; 413CDI; 414; 416CDI -Ch.: S482213 / Y422059	02.96-12.01	AV	PERROT PF 2.44 V2	EFR128	EFR129	2915301 FVR1879	98031700		
408CDI; 408D; 410D; 411CDI; 412D; 413CDI; 414; 416CDI -Ch.: S482213 / Y422059	02.96-12.01	AV	BOSCH PF 2.45 V1	EFR095	EFR096	2915301 FVR1879	98031700		

FREINAGE A DISQUE BRAKE DISC SYSTEM



MERCEDES../.

SPRINTER (904) ../.

408CDI; 408D; 410D; 411CDI; 412D; 413CDI; 414; 416CDI -Ch.: S482213 / Y422059	02.96-12.01	AV	BOSCH PF 2.45 V2	EFR126	EFR127	2915301 FVR1879	98031700		
408CDI; 408D; 410D; 411CDI; 412D; 413CDI; 414; 416CDI Ch.: S 482214/Y 422060-	01.02-05.06	AV	PERROT PF 2.44 V1	EFR051	EFR052	2915301 FVR1879	98031700		
408CDI; 408D; 410D; 411CDI; 412D; 413CDI; 414; 416CDI Ch.: S 482214/Y 422060-	01.02-05.06	AV	PERROT PF 2.44 V2	EFR128	EFR129	2915301 FVR1879	98031700		
408CDI; 408D; 410D; 411CDI; 412D; 413CDI; 414; 416CDI Ch.: S 482214/Y 422060-	01.02-05.06	AV	BOSCH PF 2.45 V1	EFR095	EFR096	2915301 FVR1879	98031700		
408CDI; 408D; 410D; 411CDI; 412D; 413CDI; 414; 416CDI Ch.: S 482214/Y 422060-	01.02-05.06	AV	BOSCH PF 2.45 V2	EFR126	EFR127	2915301 FVR1879	98031700		
408CDI; 408D; 410D; 411CDI; 412D; 413CDI; 414; 416CDI	02.96-05.06	AR	PERROT PF 2.44 V1	EFR051	EFR052	2915301 FVR1879	98031700	09.8475.10 92089803 FCR191A	
408CDI; 408D; 410D; 411CDI; 412D; 413CDI; 414; 416CDI	02.96-05.06	AR	PERROT PF 2.44 V2	EFR128	EFR129	2915301 FVR1879	98031700	09.8475.10 92089803 FCR191A	

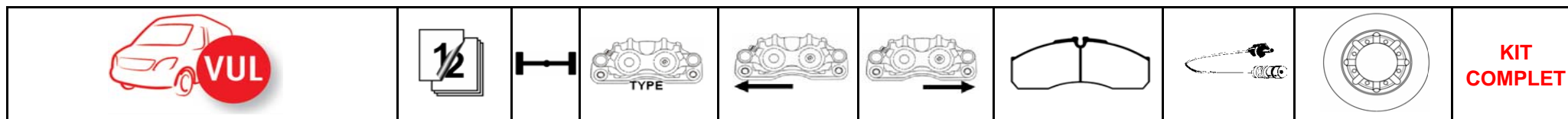
SPRINTER (905 6.t)

616CDI	04.01-	AV	BREMBO PF 2.52	522.7301.50	522.7301.60	2923701 FVR1791	98012200	Encours	
616CDI	04.01-	AR	MERITOR PFC 2.54	EFR108	EFR109	2983506 FVR1522B	98022000	Encours	

SPRINTER (906)

209CDI; 210CDI; 211CDI; 213CDI; 215CDI; 216; 216CDI; 218CDI; 219CDI; 224 (3 tonnes)	06.06-	AV	BREMBO PF 2.48	EFR065	EFR066	2919202 TU+ FVR1778 TU-	98033800	09.9508.14 93143203 FCR310A	
---	--------	----	--------------------------	---------------	---------------	--	-----------------	--	--

FREINAGE A DISQUE BRAKE DISC SYSTEM



MERCEDES../.

SPRINTER (906)../.

209CDI; 210CDI; 211CDI; 213CDI; 215CDI; 216; 216CDI; 218CDI; 219CDI; 224 (3 tonnes)	06.06-	AR	BOSCH PF 1.51	EFR073	EFR074	2919001 TU+ FVR1780 TU+	98033700	08.9509.14 93143303 FCR311A	
309CDI; 310CDI; 311CDI; 313CDI; 315CDI; 316; 316CDI; 316NGT; 318CDI; 319CDI; 324 (3,5 tonnes)	06.06-	AV	BREMBO PF 2.48	EFR065	EFR066	2919202 TU+ FVR1778 TU-	98033800	09.9508.14 93143203 FCR310A	
309CDI; 310CDI; 311CDI; 313CDI; 315CDI; 316; 316CDI; 316NGT; 318CDI; 319CDI; 324 (3,5 tonnes)	06.06-	AR	BOSCH PF 1.51	EFR073	EFR074	2919001 TU+ FVR1780 TU+	98033700	08.9509.14 93143303 FCR311A	
413CDI; 416CDI; 419CDI; 424 (4,6 tonnes)	06.06-	AV	BREMBO PF 2.52	EFR077	EFR078	2920002 FVR1779	98033800	09.9508.14 93143203 FCR310A	
413CDI; 416CDI; 419CDI; 424 (4,6 tonnes)	06.06-	AR	BOSCH PF 2.48	EFR075	EFR076	2921702 TU- FVR1779 TU- FVR4429 TU+	98033700	09.9510.14 93143403 FCR312A	
509CDI; 510CDI; 511CDI; 513CDI; 515CDI; 516CDI; 518CDI; 519CDI; 524 (5 tonnes)	06.06-	AV	BREMBO PF 2.52	EFR077	EFR078	2920002 FVR1779	98033800	09.9508.14 93143203 FCR310A	
509CDI; 510CDI; 511CDI; 513CDI; 515CDI; 516CDI; 518CDI; 519CDI; 524 (5 tonnes)	06.06-	AR	BOSCH PF 2.48	EFR075	EFR076	2921702 TU- FVR1779 TU- FVR4429 TU+	98033700	09.9510.14 93143403 FCR312A	

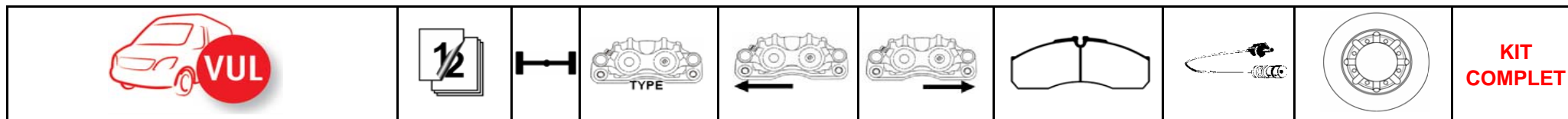
BM668 - BM669 ROUE 16"

609; 709; 709D; 711D; 809D	01.86-05.96	AV	MERITOR PF 2.60	EFR023	EFR024	2983506 FVR1522B	98022000	09.6998.10 93087400 FCR118A	
----------------------------	-------------	----	---------------------------	---------------	---------------	-----------------------------------	-----------------	--	--

BM670 ROUE 17,5"

709D; 711D; 809D; 811D; 814D	01.86-05.96	AV	MERITOR PF 2.60	EFR025	EFR026	2983506 FVR1522B	98022000	09.6969.10 93087600 FCR163A	
------------------------------	-------------	----	---------------------------	---------------	---------------	-----------------------------------	-----------------	--	--

FREINAGE A DISQUE BRAKE DISC SYSTEM



MERCEDES../.. VARIO

512D	01.95-04.02	AV	PERROT PF 2.44 V1	EFR051	EFR052	2915301 FVR1879	98031700	Encours	
512D	01.95-04.02	AR	PERROT PF 2.44 V1	EFR051	EFR052	2915301 FVR1879	98031700	Encours	

VARIO (T2W) ROUE 16"

612D; 614D	06.96-	AV	MERITOR PF 2.60	EFR023	EFR024	2983506 FVR1522B	98022000	09.6998.10 93087400 FCR118A	
612D; 614D	06.96-	AR	MERITOR PFC 2.60	EFR031	EFR032	2983506 FVR1522B	98022000	09.8206.10 93087500 FCR164A	

MERCEDES../..

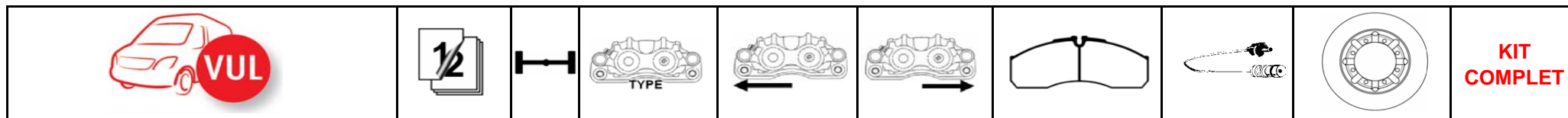
VARIO (T2W) ROUE 17,5"

812D; 814D	06.96-	AV	MERITOR PF 2.60	EFR025	EFR026	2983506 FVR1522B	98022000	09.6969.10 93087600 FCR163A	
812D; 814D	06.96-	AR	MERITOR PFC 2.60	EFR033	EFR034	2983506 FVR1522B	98022000	09.8205.10 93087700 FCR165A	

MB TRAC

MB TRAC 800 >Axle N° I 017651	01.75-	AV	ATE/TEVES P 2.60	EFR085	EFR086	2958104 FDB143		08.6750.20 93015500 FCR364A	
MB TRAC 800 >Axle N° Q 017319	01.75-	AR	ATE/TEVES PC 2.54	EFR106	EFR107	2958104 FDB143		08.6750.20 93015500 FCR364A	
MB TRAC 800 Axle N° I 017652>	01.75-	AV	ATE/TEVES P 2.60	EFR085	EFR086	2958104 FDB143		08.6750.10 93066400 FCR156A	
MB TRAC 800 Axle N° Q 017320>	01.75-	AR	ATE/TEVES PC 2.54	EFR106	EFR107	2958104 FDB143		08.6750.10 93066400 FCR156A	

FREINAGE A DISQUE BRAKE DISC SYSTEM



MERCEDES../.

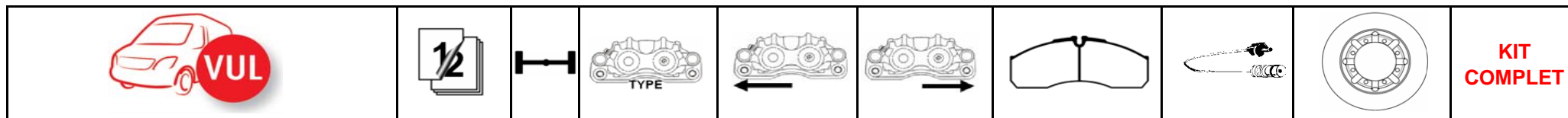
MERCEDES MB TRAC ../.

MB TRAC 900 >Axle N° I 017651	01.81-	AV	ATE/TEVES P 2.60	EFR085	EFR086	2958104 FDB143	98022100	08.6750.20 93015500 FCR364A	
MB TRAC 900 Axle N° I 017652>	01.81-	AV	ATE/TEVES P 2.60	EFR085	EFR086	2958104 FDB143	98022100	08.6750.10 93066400 FCR156A	
MB TRAC 900 Axle N° Q 017320>	01.81-	AR	ATE/TEVES PC 2.54	EFR106	EFR107	2958104 FDB143	98022100	08.6750.10 93066400 FCR156A	
MB TRAC 1000 (UP)	01.82-	AV	ATE/TEVES P 2.54	EFR093	EFR094	2958104 FDB143			
MB TRAC 1000 (DOWN) >Axle N° I 017651	01.82-	AV	ATE/TEVES P 2.60	EFR085	EFR086	2958104 FDB143	98022100	08.6750.20 93015500 FCR364A	
MB TRAC 1000 >Axle N° Q 017319	01.82-	AR	ATE/TEVES PC 2.54	EFR106	EFR107	2958104 FDB143	98022100	08.6750.20 93015500 FCR364A	
MB TRAC 1000 (DOWN) Axle N° I 017652>	01.82-	AV	ATE/TEVES P 2.60	EFR085	EFR086	2958104 FDB143	98022100	08.6750.10 93066400 FCR156A	
MB TRAC 1000 Axle N° Q 017320>	01.82-	AR	ATE/TEVES PC 2.54	EFR106	EFR107	2958104 FDB143	98022100	08.6750.10 93066400 FCR156A	

UNIMOG

UNIMOG BM 403 (SUP)	01.73-	AV	ATE/TEVES P 2.54	EFR093	EFR094	2958104 FDB143			
UNIMOG BM 403 (INF)	01.73-	AV	ATE/TEVES P 2.54	EFR085	EFR086	2958104 FDB143			
UNIMOG BM 403	01.73-	AR	ATE/TEVES PC 2.54	EFR107	EFR106	2958104 FDB143	98022100		

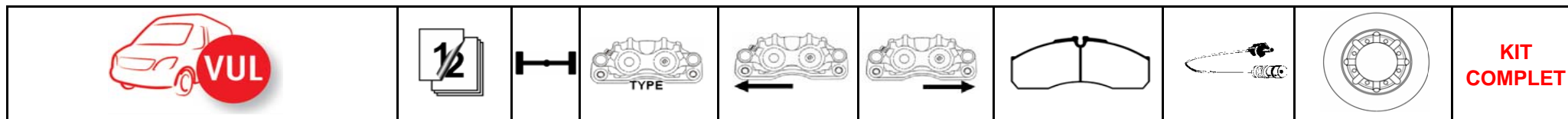
FREINAGE A DISQUE BRAKE DISC SYSTEM



MERCEDES../..
UNIMOG ../..

UNIMOG BM 405 U300	03.00-	AV	ATE/TEVES P 2.60	EFR112	EFR113	2958105	98022100	08.6750.10 93066400 FCR156A	
UNIMOG BM 405 U300	03.00-	AR	ATE/TEVES PC 2.54	EFR116	EFR117	2958105	98022100	08.6750.10 93066400 FCR156A	
UNIMOG BM 406 (SUP)	01.73-12.77	AV	ATE/TEVES P 2.54	EFR093	EFR094	2958104 FDB143			
UNIMOG BM 406 (INF)	01.73-12.77	AV	ATE/TEVES P 2.54	EFR085	EFR086	2958104 FDB143			
UNIMOG BM 406	01.73-12.77	AR	ATE/TEVES PC 2.54	EFR107	EFR106	2958104 FDB143	98022100		
UNIMOG BM 413 (SUP)	01.73-	AV	ATE/TEVES P 2.54	EFR093	EFR094	2958104 FDB143			
UNIMOG BM 413 (INF)	01.73-	AV	ATE/TEVES P 2.54	EFR085	EFR086	2958104 FDB143			
UNIMOG BM 413	01.73-	AR	ATE/TEVES PC 2.54	EFR107	EFR106	2958104 FDB143	98022100		
UNIMOG BM 416 (SUP)	01.73-	AV	ATE/TEVES P 2.54	EFR093	EFR094	2958104 FDB143			
UNIMOG BM 416 (INF)	01.73-	AV	ATE/TEVES P 2.54	EFR085	EFR086	2958104 FDB143			
UNIMOG BM 416	01.73-	AR	ATE/TEVES PC 2.54	EFR107	EFR106	2958104 FDB143	98022100		
UNIMOG BM 424	01.77-	AV	ATE/TEVES P 2.54	EFR093	EFR094	2958104 FDB143			
UNIMOG BM 424	01.77-	AV	ATE/TEVES P 2.54	EFR085	EFR086	2958104 FDB143			
UNIMOG BM 424	01.77-	AR	ATE/TEVES PC 2.54	EFR106	EFR107	2958104 FDB143	98022100		
UNIMOG BM 425	01.74-	AV	ATE/TEVES P 4.48/57	EFR110	EFR111	2976402 FCV958			

FREINAGE A DISQUE BRAKE DISC SYSTEM



MERCEDES../.. UNIMOG ../..

UNIMOG BM 425	01.74-	AR	ATE/TEVES P 4.48/57	EFR114	EFR115	2976502 FCV959			
UNIMOG BM 427	01.97-	AR	ATE/TEVES PC 2.54	EFR116	EFR117	2958105	98022100	08.6750.10 93066400 FCR156A	
UNIMOG BM 435	01.74-12.77	AV	ATE/TEVES P 4.48/57	EFR110	EFR111	2976402 FCV958			
UNIMOG BM 435 (SUP)	01.78-	AV	ATE/TEVES P 2.54	EFR093	EFR094	2958104 FDB143			
UNIMOG BM 435 (INF)	01.78-	AV	ATE/TEVES P 2.54	EFR085	EFR086	2958104 FDB143			
UNIMOG BM 435	01.74-	AR	ATE/TEVES P 4.48/57	EFR114	EFR115	2976502 FCV959			
UNIMOG BM 435	01.78-	AR	ATE/TEVES PC 2.54	EFR106	EFR107	2958104 FDB143	98022100		

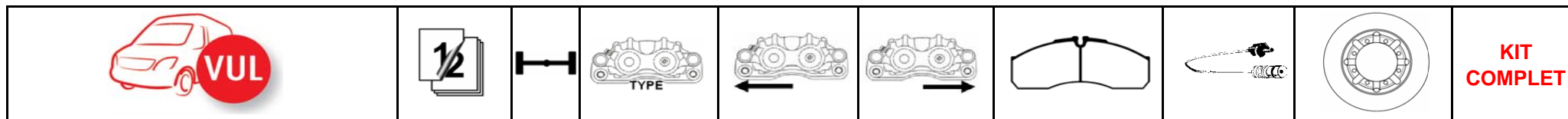
MITSUBISHI CANTER (2 ETRIER/ROUE)

3,0 DTDI (vis purge+) SUPERIEUR	08.01-	AV	SUMITOMO PF 1.48	EFR069	EFR070	2924201 (8) FVR1906			
3,0 DTDI (vis purge-) INFERIEUR	08.01-	AV	SUMITOMO PF 1.48	EFR071	EFR072	2924201 (8) FVR1906			
3,0 DTDI (vis purge+) SUPERIEUR	08.01-	AV	SUMITOMO PF 1.54	EFR176	EFR177				
3,0 DTDI (vis purge-) INFERIEUR	08.01-	AV	SUMITOMO PF 1.54	EFR178	EFR179				

MULTICAR

M26 2,8	01.96-12.02	AV	KNOTT P 2.46	EFR118	EFR119	2920801 FVR1761			
M26 2,8 Diesel	01.03-	AV	KNOTT P 2.46	EFR118	EFR119	2920801 FVR1761			
M26 3,0 Diesel	09.06-	AV	KNOTT P 2.46	EFR118	EFR119	2920801 FVR1761			

FREINAGE A DISQUE BRAKE DISC SYSTEM



NISSAN PRIMASTAR (X83)

2.0; dCi 80; dCi 90; dCi 100; dCi 120; dCi 140; dCi 150	09.02-	AV	TRW/LUCAS PF 2.40/45	EFR015	EFR016	2309902 FVR1515	09.8937.10 92116003 DDF1204C-1	
2.0; dCi 80; dCi 90; dCi 100; dCi 120; dCi 140; dCi 150	09.02-	AR	TRW/LUCAS PFC 1.41	EFR017	EFR018	2398001 FVR1516	08.9597.17 92153703 DDF1623-1	

INTERSTAR (X70) (JANTE 16")

INTERSTAR dCi 80; dCi 90; dCi 100; dCi 120; dCi 140; dCi 150	07.02-	AV	BOSCH PF 2.45	EFR009	EFR010	2361301 FVR1452	09.9080.10 92115903 DDF1217C-1	
INTERSTAR dCi 80; dCi 90; dCi 100; dCi 120; dCi 140; dCi 150	07.02-	AR	BOSCH PFC 1.42	EFR013	EFR014	2366901 FVR1453	08.9371.10 92111203 DDF1272C	

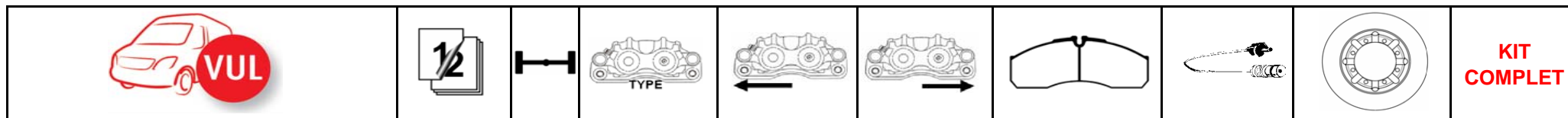
NV400 (RWD-PROPULSION)

NV400 2,3 dCi	11.11-	AV	BREMBO PF 2.48	EFR087	EFR088	2514701 FVR4347	09.B633.10 92228600 DDF1974C-1	KDC1003
NV400 2,3 dCi Roue simple	11.11-	AR	BREMBO PFC 1.48	EFR089	EFR090	2511201 FVR4348	08.A651.10 92228800 DDF1976C	KDC3004
NV400 2,3 dCi Roue jumelée	11.11-	AR	BREMBO PFC 1.60	EFR091	EFR092	2517201 FVR4349	08.A650.10 92230800 DDF1977C	KDC3006

NV400 (FWD-TRACTION)

NV400 2,3 dCi	11.11-	AV	BREMBO PF 2.48	EFR087	EFR088	2514701 FVR4347	09.B633.10 92228600 DDF1974C-1	KDC1003
NV400 2,3 dCi Roue simple	11.11-	AR	BREMBO PFC 1.48	EFR089	EFR090	2511201 FVR4348	08.B829.10 92228700 DDF1975C	KDC3005

FREINAGE A DISQUE BRAKE DISC SYSTEM



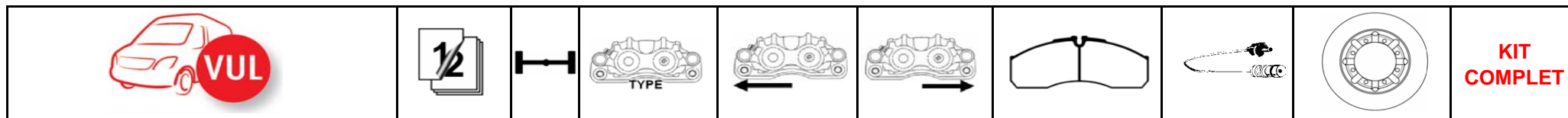
NISSAN ../. CABSTAR E

75.28; 90.32; 105.35; 110.35; 120.35; 125.35	10.98-10.06	AV	BOSCH PF 2.48	EFR079	EFR080	2343501 FVR1616		09.B497.10 93185303 FCR261A	
75.28; 90.32; 105.35; 110.35; 120.35; 125.35	10.98-10.06	AV	BOSCH PF 2.48	EFR079	EFR080	2343501 FVR1616		09.8965.10 93240600 FCR339A	
75.28; 90.32; 105.35; 110.35; 120.35; 125.35	10.98-10.06	AV	BENDIX PF 2.48	EFR081	EFR082	2998401 FVR792		09.8965.10 93240600 FCR339A	
110.45; 120.45;	10.98-10.06	AV	BENDIX PF 2.52	EFR005	EFR006	2998401 FVR792		09.8965.10 93240600 FCR339A	

CABSTAR

28.11; 28.12; 32.11; 35.11; 35.12; 35.13; 35.14; 35.15	10.06-	AV	BREMBO PF 2.48	522.9700.76	522.9700.86	507.9703.16 2922902 FVR4053		09.B410.10 FCR326A	KDC1002
28.11; 28.12; 32.11; 35.11; 35.12; 35.13; 35.14; 35.15 (ABS-)	10.06-	AR	BREMBO PFC 1.46	522.9715.75	522.9715.85	507.8156.42 2392103 FVR4054		08.9794.10 FCR327A	KDC3003
28.11; 28.12; 32.11; 35.11; 35.12; 35.13; 35.14; 35.15 (ABS+)	10.06-	AR	BREMBO PFC 1.46	522.9715.75	522.9715.85	507.8156.42 2392103 FVR4054		08.9794.60 FCR369A	KDC3002
45.13; 45.15	10.06-	AV	BREMBO PF 2.52	522.7301.28	522.7301.29	2932701 FVR4248		09.8965.10 93240600 FCR339A	
45.13; 45.15	10.06-	AR	BREMBO PF 2.44	522.7775.28	522.7775.29	507.5944.54 2912113 FVR4156		09.7263.30 FCR340A	

FREINAGE A DISQUE BRAKE DISC SYSTEM



NISSAN ../.. NT500

35.15, 35.15 HD	05.13-	AV	BREMBO PF 2.52	522.7301.74	522.7301.84	2932701 FVR4248		09.8965.10 93240600 FCR339A	
35.15, 35.15 HD	05.13-	AR	BREMBO PF 2.44	522.7775.28	522.7775.29	507.5944.54 2912113 FVR4156		09.7263.30 FCR340A	
56.15; 65.15	05.13-	AV	BREMBO PF 2.60			29122xx			
56.15; 65.15	05.13-	AR	BREMBO			2923103			

OPEL VIVARO (J7-F7-E7)

1.9 DI; 1.9 DTI; 2.0 16V; 2.0 CDTI; 2.0 ECOTEC; 2.5 CDTI; 2.5 DTI	08.01-	AV	TRW/LUCAS PF 2.40/45	EFR015	EFR016	2309902 FVR1515		09.8937.10 92116003 DDF1204C-1	
1.9 DI; 1.9 DTI; 2.0 16V; 2.0 CDTI; 2.0 ECOTEC; 2.5 CDTI; 2.5 DTI	08.01-	AR	TRW/LUCAS PFC 1.41	EFR017	EFR018	2398001 FVR1516		08.9597.17 92153703 DDF1623-1	

MOVANO (H9-F9-J9) (JANTE 15")

1.9 DTI; 2.5 D; 2.8 DTI	01.99-10.01	AV	BOSCH PF 2.45	EFR007	EFR008	2330201 FVR1292		09.7717.10 92097703 DDF1067C	
-------------------------	-------------	----	--------------------------	---------------	---------------	----------------------------	--	---	--

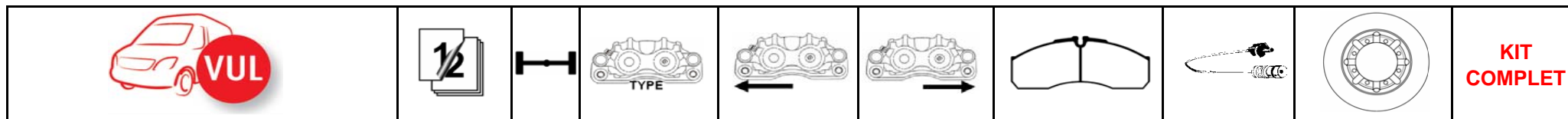
MOVANO (H9-F9-J9) (JANTE 16")

1.9 DTI; 2.2 DTI; 2.5 CDTI; 2.5 Dti; 3.0 DTI	10.01-04.10	AV	BOSCH PF 2.45	EFR009	EFR010	2361301 FVR1452		09.9080.10 92115903 DDF1217C-1	
--	-------------	----	--------------------------	---------------	---------------	----------------------------	--	---	--

MOVANO (H9-F9-J9) (JANTE 16")../..

1.9 DTI; 2.2 DTI; 2.5 CDTI; 2.5 Dti; 3.0 DTI	10.01-04.10	AR	BOSCH PFC 1.42	EFR013	EFR014	2366901 FVR1453		08.9371.10 92111203 DDF1272C	
--	-------------	----	---------------------------	---------------	---------------	----------------------------	--	---	--

FREINAGE A DISQUE BRAKE DISC SYSTEM



OPEL ../.. MOVANO B (RWD-PROPULSION)

MOVANO B 2,3 CDTI	05.10-	AV	BREMBO PF 2.48	EFR087	EFR088	2514701 FVR4347		09.B633.10 92228600 DDF1974C-1	KDC1003
MOVANO B 2,3 CDTI Roue simple	05.10-	AR	BREMBO PFC 1.48	EFR089	EFR090	2511201 FVR4348		08.A651.10 92228800 DDF1976C	KDC3004
MOVANO B 2,3 CDTI Roue jumelée	05.10-	AR	BREMBO PFC 1.60	EFR091	EFR092	2517201 FVR4349		08.A650.10 92230800 DDF1977C	KDC3006

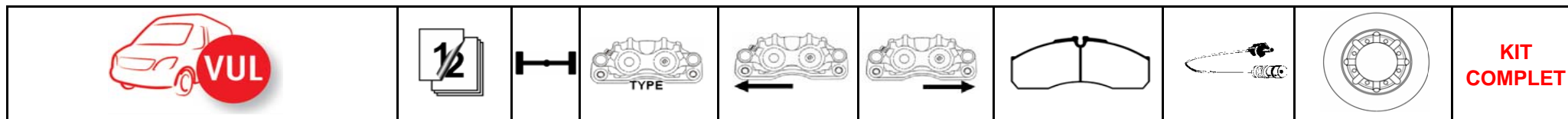
MOVANO B (FWD-TRACTION)

MOVANO B 2,3 CDTI	05.10-	AV	BREMBO PF 2.48	EFR087	EFR088	2514701 FVR4347		09.B633.10 92228600 DDF1974C-1	KDC1003
MOVANO B 2,3 CDTI Roue simple	05.10-	AR	BREMBO PFC 1.48	EFR089	EFR090	2511201 FVR4348		08.B829.10 92228700 DDF1975C	KDC3005

PEUGEOT BOXER

1000; 1400 (230P, 230L) (ABS-)	09.01-03.02	AV	BREMBO PF 2.44/48	522.8142.45	522.8142.55	2391701 FVR1478			
1000; 1400 (230P, 230L) (ABS-)	09.01-03.02	AR	BREMBO PF 1.46	522.8153.12	522.8153.22	2392101 FVR1480			
1100; 1500 (244) (ABS-)	04.02-06.06	AV	BREMBO PF 2.44/48	522.8142.45	522.8142.55	2391701 FVR1478		09.8931.20 92275103 DDF1170C	
1100; 1500 (244) (ABS-)	04.02-06.06	AR	BREMBO PF 1.46	522.8153.12	522.8153.22	2392101 FVR1480		08.8094.30 92116103 DDF1144C	
1000; 1400 (230P, 230L) (ABS+)	09.01-03.02	AV	BREMBO PF 2.44/48	522.8142.46	522.8142.56	2391701 FVR1478			

FREINAGE A DISQUE BRAKE DISC SYSTEM



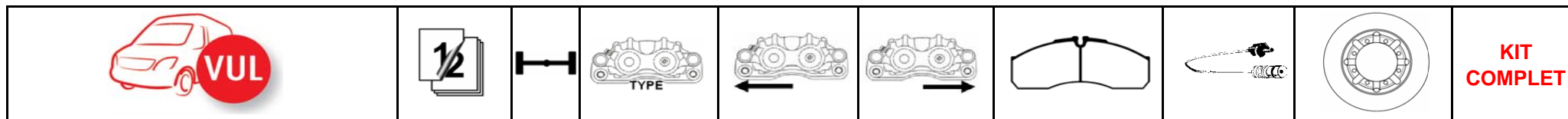
PEUGEOT ../. BOXER ../.

1000; 1400 (230P, 230L) (ABS+)	09.01-03.02	AR	BREMBO PF 1.46	522.8153.12	522.8153.22	2392101 FVR1480			
1100; 1500 (244) (ABS+)	04.02-06.06	AV	BREMBO PF 2.44/48	522.8142.46	522.8142.56	2391701 FVR1478		09.8931.20 92275103 DDF1170C	
1100; 1500 (244) (ABS+)	04.02-06.06	AR	BREMBO PF 1.46	522.8153.12	522.8153.22	2392101 FVR1480		08.8094.30 92116103 DDF1144C	
1800; 350 (230P, 230L, 244) (ABS-)	09.01-06.06	AV	BREMBO PF 2.46/52	522.8148.45	522.8148.55	2391901 FVR1479		09.8932.10 92116703 DDF768C	
1800; 350 (230P, 230L, 244) (ABS-)	09.01-06.06	AR	BREMBO PF 1.46	522.8153.12	522.8153.22	2392101 FVR1480		08.8094.40 92116203 DDF1145	
1800; 350 (230P, 230L, 244) (ABS+)	09.01-06.06	AV	BREMBO PF 2.46/52	522.8148.46	522.8148.56	2391901 FVR1479		09.8932.10 92116703 DDF768C	
1800; 350 (230P, 230L, 244) (ABS+)	09.01-06.06	AR	BREMBO PF 1.46	522.8153.12	522.8153.22	2392101 FVR1480		08.8094.40 92116203 DDF1145	

RENAULT TRAFIC II (JL, FL)

1,9 dCi 100	03.01-	AV	TRW/LUCAS PF 2.40/45	EFR015	EFR016	2309902 FVR1515		09.8937.10 92116003 DDF1204C-1	
1,9 dCi 100	03.01-	AR	TRW/LUCAS PFC 1.41	EFR017	EFR018	2398001 FVR1516		08.9597.17 92153703 DDF1623-1	
1,9 dCi 80	03.01-	AV	TRW/LUCAS PF 2.40/45	EFR015	EFR016	2309902 FVR1515		09.8937.10 92116003 DDF1204C-1	

FREINAGE A DISQUE BRAKE DISC SYSTEM



RENAULT ../. TRAFIC II (JL, FL) ../.

1,9 dCi 80	03.01-	AR	TRW/LUCAS PFC 1.41	EFR017	EFR018	2398001 FVR1516		08.9597.17 92153703 DDF1623-1	
2,0	03.01-	AV	TRW/LUCAS PF 2.40/45	EFR015	EFR016	2309902 FVR1515		09.8937.10 92116003 DDF1204C-1	
2,0	03.01-	AR	TRW/LUCAS PFC 1.41	EFR017	EFR018	2398001 FVR1516		08.9597.17 92153703 DDF1623-1	
2,0 dCi 90, 115, 2,5 dCi 135, 145	03.01-04.14	AV	TRW/LUCAS PF 2.40/45	EFR015	EFR016	2309902 FVR1515		09.8937.10 92116003 DDF1204C-1	
2,0 dCi 90, 115, 2,5 dCi 135, 145	03.01-04.14	AR	TRW/LUCAS PFC 1.41	EFR017	EFR018	2398001 FVR1516		08.9597.17 92153703 DDF1623-1	

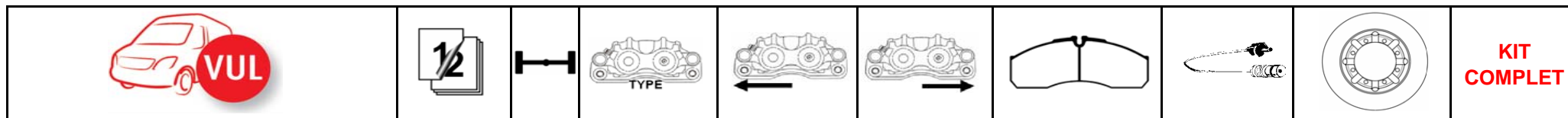
TRAFIC III

1,6 dCi 90, 115, 120, 140	05.14-	AV	TRW/LUCAS PF			2208701 FVR4840		92268803 DDF2507C	
---------------------------	--------	----	-----------------	--	--	----------------------------	--	------------------------------	--

MASTER II

MASTER II 1,9 dTi (JANTE 15")	01.00-07.00	AV	BOSCH PF 2.45	EFR007	EFR008	2330201 FVR1292		09.7717.10 92097703 DDF1067C	
MASTER II 1,9 dTi (JANTE 16")	08.00-02.10	AV	BOSCH PF 2.45	EFR009	EFR010	2361301 FVR1452		09.9080.10 92115903 DDF1217C-1	
MASTER II 1,9 dTi (JANTE 16")	08.00-02.10	AR	BOSCH PFC 1.42	EFR013	EFR014	2366901 FVR1453		08.9371.10 92111203 DDF1272C	
MASTER II 1,9 dCi (JANTE 16")	05.00-12.04	AV	BOSCH PF 2.45	EFR009	EFR010	2361301 FVR1452		09.9080.10 92115903 DDF1217C-1	

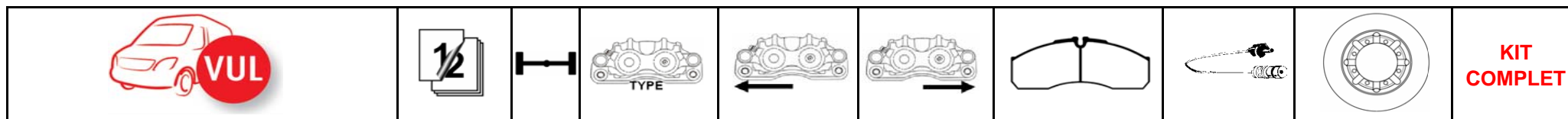
FREINAGE A DISQUE BRAKE DISC SYSTEM



**RENAULT ../..
MASTER II../..**

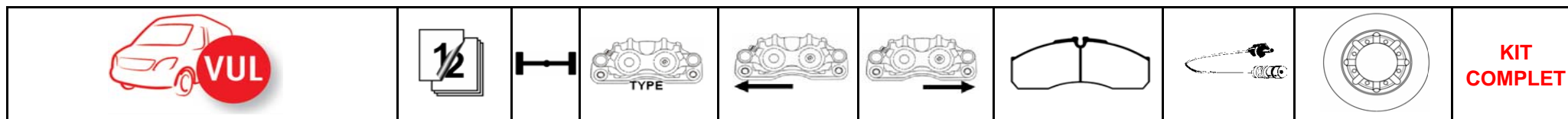
MASTER II 1,9 dCi (JANTE 16")	05.00-12.04	AR	BOSCH PFC 1.42	EFR013	EFR014	2366901 FVR1453	08.9371.10 92111203 DDF1272C	
MASTER II 1,9 dCi (JANTE 16")	01.05-02.10	AV	BOSCH PF 2.45	EFR011	EFR012	2361301 FVR1452	09.9080.10 92115903 DDF1217C-1	
MASTER II 1,9 dCi (JANTE 16")	01.05-02.10	AR	BOSCH PFC 1.42	EFR013	EFR014	2366901 FVR1453	08.9371.10 92111203 DDF1272C	
MASTER II 2,2 dCi (JANTE 16")	01.00-02.10	AV	BOSCH PF 2.45	EFR009	EFR010	2361301 FVR1452	09.9080.10 92115903 DDF1217C-1	
MASTER II 2,2 dCi (JANTE 16")	01.00-02.10	AR	BOSCH PFC 1.42	EFR013	EFR014	2366901 FVR1453	08.9371.10 92111203 DDF1272C	
MASTER II 2,5 dCi (JANTE 16")	05.00-02.10	AV	BOSCH PF 2.45	EFR009	EFR010	2361301 FVR1452	09.9080.10 92115903 DDF1217C-1	
MASTER II 2,5 dCi (JANTE 16")	05.00-02.10	AR	BOSCH PFC 1.42	EFR013	EFR014	2366901 FVR1453	08.9371.10 92111203 DDF1272C	
MASTER II 2,5 D (JANTE 15")	10.97-07.00	AV	BOSCH PF 2.45	EFR007	EFR008	2330201 FVR1292	09.7717.10 92097703 DDF1067C	
MASTER II 2,5 D (JANTE 16")	08.00-02.10	AV	BOSCH PF 2.45	EFR009	EFR010	2361301 FVR1452	09.9080.10 92115903 DDF1217C-1	
MASTER II 2,5 D (JANTE 16")	08.00-02.10	AR	BOSCH PFC 1.42	EFR013	EFR014	2366901 FVR1453	08.9371.10 92111203 DDF1272C	

FREINAGE A DISQUE BRAKE DISC SYSTEM



**RENAULT ./../
MASTER II./../**

MASTER II 2,8 D (JANTE 16")	05.00-02.10	AV	BOSCH PF 2.45	EFR009	EFR010	2361301 FVR1452		09.9080.10 92115903 DDF1217C-1	
MASTER II 2,8 D (JANTE 16")	05.00-02.10	AR	BOSCH PFC 1.42	EFR013	EFR014	2366901 FVR1453		08.9371.10 92111203 DDF1272C	
MASTER II 2,8 dTi (JANTE 15")	07.98-10.01	AV	BOSCH PF 2.45	EFR007	EFR008	2330201 FVR1292		09.7717.10 92097703 DDF1067C	
MASTER II 2,8 dTi (JANTE 16")	11.01-02.10	AV	BOSCH PF 2.45	EFR009	EFR010	2361301 FVR1452		09.9080.10 92115903 DDF1217C-1	
MASTER II 2,8 dTi (JANTE 16")	11.01-02.10	AR	BOSCH PFC 1.42	EFR013	EFR014	2366901 FVR1453		08.9371.10 92111203 DDF1272C	
MASTER II 3,0 dCi 120, 140, 160	10.03-02.10	AV	BOSCH			2361301 FVR1452		09.9080.10 92115903 DDF1217C-1	
MASTER II 3,0 dCi 120, 140, 160	10.03-02.10	AR	BOSCH			2366901 FVR1453		08.9371.10 92111203 DDF1272C	
MASTER II Propulsion	01.99-02.10	AV	BREMBO PF 2.44	522.7773.73	522.7773.83	507.5944.32 2912111 FVR1315	98028500	09.7262.10 93117400 FCR183A	
MASTER II Propulsion	01.99-02.10	AR	BREMBO PF 2.44	522.7775.73	522.7775.83	507.5944.32 2912111 FVR1315	98028500	09.7263.20 93117600 FCR184A	HBK2001 ou/or HBK2001+



RENAULT ../.

MASTER III (RWD-PROPULSION)

MASTER III 2,3 dCi	02.10-	AV	BREMBO PF 2.48	EFR087	EFR088	2514701 FVR4347		09.B633.10 92228600 DDF1974C-1	KDC1003
MASTER III 2,3 dCi Roue simple	02.10-	AR	BREMBO PFC 1.48	EFR089	EFR090	2511201 FVR4348		08.A651.10 92228800 DDF1976C	KDC3004
MASTER III 2,3 dCi Roue jumelée	02.10-	AR	BREMBO PFC 1.60	EFR091	EFR092	2517201 FVR4349		08.A650.10 92230800 DDF1977C	KDC3006

MASTER III (FWD-TRACTION)

MASTER III 2,3 dCi	02.10-	AV	BREMBO PF 2.48	EFR087	EFR088	2514701 FVR4347		09.B633.10 92228600 DDF1974C-1	KDC1003
MASTER III 2,3 dCi Roue simple	02.10-	AR	BREMBO PFC 1.48	EFR089	EFR090	2511201 FVR4348		08.B829.10 92228700 DDF1975C	KDC3005

RENAULT TRUCKS

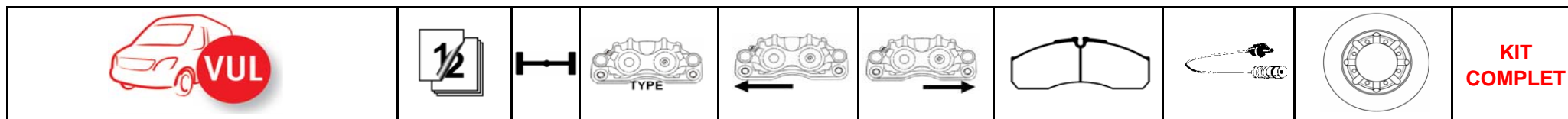
B SERIE

B70; B80; B90; B110; B120	10.92-12.99	AV	BENDIX PF 2.52	EFR005	EFR006	2907102 FVR627		09.6734.20 93085800 FCR169A	
---------------------------	-------------	----	-------------------	--------	--------	-------------------	--	-----------------------------------	--

MAXITY

110.28; 110.32; 110.35; 130.35; 150.35	10.07-	AV	BREMBO PF 2.48	522.9700.76	522.9700.86	507.9703.16 2922902 FVR4053		09.B410.10 FCR326A	KDC1002
110.28; 110.32; 110.35; 130.35; 150.35 ABS-	10.07-	AR	BREMBO PFC 1.46	522.9715.75	522.9715.85	507.8156.42 2392103 FVR4054		08.9794.10 FCR327A	KDC3003
110.28; 110.32; 110.35; 130.35; 150.35 ABS+	10.07-	AR	BREMBO PFC 1.46	522.9715.75	522.9715.85	507.8156.42 2392103 FVR4054		08.9794.60 FCR369A	KDC3002

FREINAGE A DISQUE BRAKE DISC SYSTEM



RENAULT TRUCKS ../. MAXITY ../.

130.45; 140.45; 150.45;	10.07-	AV	BREMBO PF 2.52	522.7301.28	522.7301.29	2932701 FVR4248		09.8965.10 93240600 FCR339A	
130.45; 140.45; 150.45;	10.07-	AR	BREMBO PF 2.44	522.7775.28	522.7775.29	507.5944.54 2912113 FVR4156		09.7263.30 FCR340A	

MASCOTT 90-110

3,5 > 5,0 t.	01.99-12.07	AV	BREMBO PF 2.44	522.7773.73	522.7773.83	507.5944.32 2912111 FVR1315	98028500	09.7262.10 93117400 FCR183A	
3,5 > 5,0 t. pont 569	01.99-12.07	AR	BREMBO PF 2.44	522.7775.73	522.7775.83	507.5944.32 2912111 FVR1315	98028500	09.7263.20 93117600 FCR184A	HBK2001 ou/or HBK2001+

MASCOTT 110-120

5,0 > 6,0 t.	01.99-12.07	AV	BREMBO PF 2.52	522.7301.73	522.7301.83	507.7304.18 2916002 FVR1390	98028500	09.7261.10 93117500 FCR182A	
5,0 > 6,0 t. pont 669	01.99-12.07	AR	BREMBO PF 2.46	522.7306.28	522.7306.29	507.5944.32 2912111 FVR1315	98028500	09.7263.20 93117600 FCR184A	

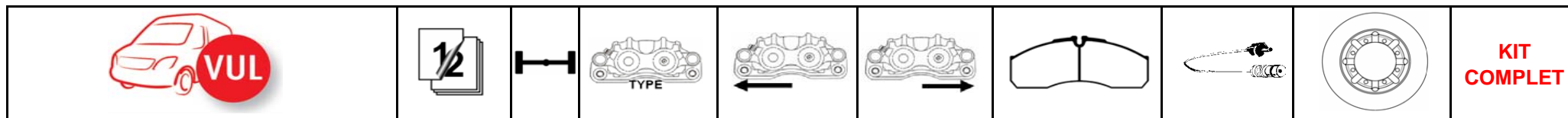
D SERIE

6.5 P 150	01.16-	AV	BREMBO						
6.5 P 150	01.16-	AR	BREMBO			2923103			

MIDLINER S/M

M140.12; M140.13	04.86-12.94	AV	SEE PAM P 4.67	EFR001	EFR002	2901302 FCV668		09.6732.20 93085900 FCR126A	
M140.12; M140.13	01.95-01.00	AV	SEE PAM P 4.67	EFR001	EFR002	2909702 FCV1046		09.6732.20 93085900 FCR126A	

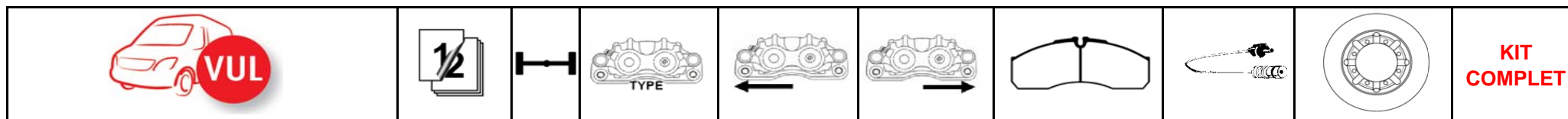
FREINAGE A DISQUE BRAKE DISC SYSTEM



RENAULT TRUCKS ../.. MIDLINER S/M ../..

M150.09; M150.11; M150.12; M150.13	04.86-12.94	AV	SEE PAM P 4.67	EFR001	EFR002	2901302 FCV668		09.6732.20 93085900 FCR126A	
M150.09; M150.11; M150.12; M150.13	01.95-01.00	AV	SEE PAM P 4.67	EFR001	EFR002	2909702 FCV1046		09.6732.20 93085900 FCR126A	
M160.12; M160.13; M160.14; M160.15	04.86-12.94	AV	SEE PAM P 4.67	EFR001	EFR002	2901302 FCV668		09.6732.20 93085900 FCR126A	
M160.12; M160.13; M160.14; M160.15	01.95-01.00	AV	SEE PAM P 4.67	EFR001	EFR002	2909702 FCV1046		09.6732.20 93085900 FCR126A	
M180.10; M180.11; M180.12; M180.13	04.86-12.94	AV	SEE PAM P 4.67	EFR001	EFR002	2901302 FCV668		09.6732.20 93085900 FCR126A	
M180.10; M180.11; M180.12; M180.13	01.95-01.00	AV	SEE PAM P 4.67	EFR001	EFR002	2909702 FCV1046		09.6732.20 93085900 FCR126A	
M200.10; M200.12; M200.13; M200.14	04.86-12.94	AV	SEE PAM P 4.67	EFR001	EFR002	2901302 FCV668		09.6732.20 93085900 FCR126A	
M200.10; M200.12; M200.13; M200.14	01.95-01.00	AV	SEE PAM P 4.67	EFR001	EFR002	2909702 FCV1046		09.6732.20 93085900 FCR126A	
M210.12; M210.13; M210.14	01.95-01.00	AV	SEE PAM P 4.67	EFR001	EFR002	2909702 FCV1046		09.6732.20 93085900 FCR126A	
M210.12; M210.13; M210.14	04.86-12.94	AV	SEE PAM P 4.67	EFR001	EFR002	2901302 FCV668		09.6732.20 93085900 FCR126A	

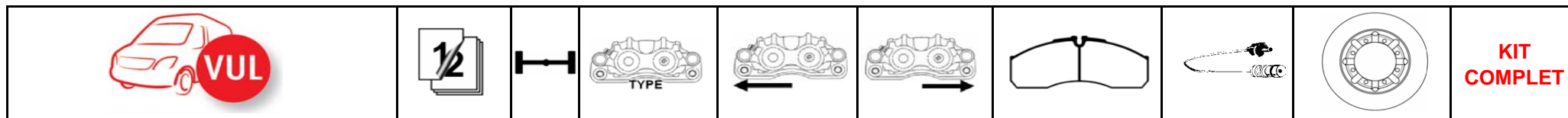
FREINAGE A DISQUE BRAKE DISC SYSTEM



RENAULT TRUCKS ../.. MIDLINER S/M ../..

M230.10; M230.12; M230.13	01.95-01.00	AV	SEE PAM P 4.67	EFR001	EFR002	2909702 FCV1046		09.6732.20 93085900 FCR126A	
M230.10; M230.12; M230.13	04.86-12.94	AV	SEE PAM P 4.67	EFR001	EFR002	2901302 FCV668		09.6732.20 93085900 FCR126A	
M250.12; M250.13 ROUE 19,5"	01.95-01.00	AV	SEE PAM P 4.67	EFR001	EFR002	2909702 FCV1046		09.6732.20 93085900 FCR126A	
M250.12; M250.13 ROUE 19,5"	04.86-12.94	AV	SEE PAM P 4.67	EFR001	EFR002	2901302 FCV668		09.6732.20 93085900 FCR126A	
S120.07/A; S120.08/A (40K) ROUE 16"	09.90-10.94	AV	MERITOR PF 2.60	EFR035	EFR036	2906504 FCV879	98022200		
S120.09 (40N) ROUE 17,5"	09.90-12.92	AV	MERITOR PF 2.68	EFR037	EFR038	2906705 FCV733	98022200	09.6732.20 93085900 FCR126A	
S120.09/B ROUE 17,5"	01.93-10.94	AV	MERITOR PF 2.68	EFR037	EFR038	2906705 FCV733	98022200	09.6732.20 93085900 FCR126A	
S130.11 ROUE 19,5"	01.95-01.00	AV	SEE PAM P 4.67	EFR001	EFR002	2909702 FCV1046		09.6732.20 93085900 FCR126A	
S130.11; S130.14; S130.13 ROUE 19,5"	04.86-12.94	AV	SEE PAM P 4.67	EFR001	EFR002	2901302 FCV668		09.6732.20 93085900 FCR126A	
S130.13; S130.14; S150.13 ti; S150.14 ti	01.95-01.00	AV	SEE PAM P 4.67	EFR001	EFR002	2909702 FCV1046		09.6732.20 93085900 FCR126A	
S135.07/A; S135.08/A ROUE 16"	05.96-01.00	AV	MERITOR PF 2.60	EFR035	EFR036	2906504 FCV879	98022200		

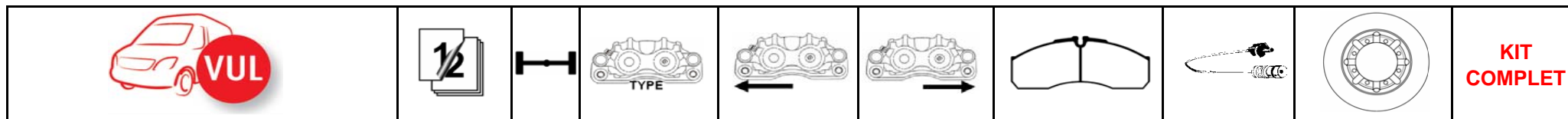
FREINAGE A DISQUE BRAKE DISC SYSTEM



RENAULT TRUCKS ../. MIDLINER S/M ../.

S135.09/B ROUE 17,5"	05.96-01.00	AV	MERITOR PF 2.68	EFR037	EFR038	2906705 FCV733	98022200		
S140.07; S140.08 (40K) ROUE 16"	09.90-10.94	AV	MERITOR PF 2.60	EFR035	EFR036	2906504 FCV879	98022200		
S140.09 (40N) ROUE 17,5"	09.90-10.94	AV	MERITOR PF 2.68	EFR037	EFR038	2906705 FCV733	98022200		
S150.07/A; S150.08/A ROUE 16"	05.96-01.00	AV	MERITOR PF 2.60	EFR035	EFR036	2906504 FCV879	98022200		
S150.09/B; S150.10/B ROUE 17,5"	01.94-01.00	AV	MERITOR PF 2.68	EFR037	EFR038	2906705 FCV733	98022200		
S150.11ti; 170.11; 170.13	01.95-01.00	AV	SEE PAM P 4.67	EFR001	EFR002	2909702 FCV1046		09.6732.20 93085900 FCR126A	
S150.13; S150.14; S150.11 ROUE 19,5"	04.86-12.94	AV	SEE PAM P 4.67	EFR001	EFR002	2901302 FCV668		09.6732.20 93085900 FCR126A	
S160.06; S160.07; S160.08(40K) ROUE 16"	01.90-09.93	AV	MERITOR PF 2.60	EFR035	EFR036	2906504 FCV879	98022200		
S160.09 (40N) ROUE 17,5"	01.90-09.93	AV	MERITOR PF 2.68	EFR037	EFR038	2906705 FCV733	98022200		
S170.11; S170.13 ROUE 19,5"	04.86-12.94	AV	SEE PAM P 4.67	EFR001	EFR002	2901302 FCV668		09.6732.20 93085900 FCR126A	
S180.07/A; S180.08/A ROUE 16"	01.92-01.00	AV	MERITOR PF 2.60	EFR035	EFR036	2906504 FCV879	98022200		
S180.09/B; S180.10/B ROUE 17,5"	01.92-01.00	AV	MERITOR PF 2.68	EFR037	EFR038	2906705 FCV733	98022200		
S210.07/A; S210.08/A ROUE 16"	01.92-01.00	AV	MERITOR PF 2.60	EFR035	EFR036	2906504 FCV879	98022200		
S210.09/B; S210.10/B ROUE 17,5"	01.92-01.00	AV	MERITOR PF 2.68	EFR037	EFR038	2906705 FCV733	98022200		

FREINAGE A DISQUE BRAKE DISC SYSTEM



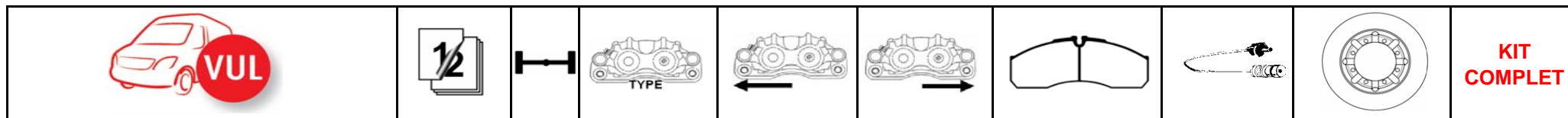
VOLKSWAGEN LT II

LT46	04.96-05.06	AV	PERROT PF 2.44	EFR051	EFR052	2915301 FVR1879	98031700		
LT46	06.02-04.06	AV	BOSCH PF 2.45	EFR095	EFR096	2915301 FVR1879	98031700		
LT46	04.96-05.06	AR	PERROT PF 2.44	EFR051	EFR052	2915301 FVR1879	98031700	09.8475.10 92089803 FCR191A	

CRAFTER

30-35 2,0 TDI; 2,5 TDI	04.06-04.17	AV	BREMBO PF 2.48	EFR065	EFR066	2919202 TU+ FVR1778 TU-	98033800	09.9508.14 93143203 FCR310A	
30-35 2,0 TDI; 2,5 TDI	04.06-04.17	AR	BOSCH PF 1.51	EFR073	EFR074	2919001 TU+ FVR1780 TU+	98033700	08.9509.14 93143303 FCR311A	
30-50 2,0 TDI; 2,5 TDI	04.06-04.17	AV	BREMBO PF 2.48	EFR065	EFR066	2919202 TU+ FVR1778 TU-	98033800	09.9508.14 93143203 FCR310A	
30-50 2,0 TDI; 2,5 TDI (roue simple)	04.06-04.17	AR	BOSCH PF 1.51	EFR073	EFR074	2919001 TU+ FVR1780 TU+	98033700	08.9509.14 93143303 FCR311A	
30-50 2,0 TDI; 2,5 TDI	04.06-04.17	AV	BREMBO PF 2.52	EFR077	EFR078	2920002 FVR1779	98033800	09.9508.14 93143203 FCR310A	
30-50 2,0 TDI; 2,5 TDI (roue jumelée)	04.06-04.17	AR	BOSCH PF 2.48	EFR075	EFR076	2921702 TU- FVR1779 TU- FVR4429 TU+	98033700	09.9510.14 93143403 FCR312A	

FREINAGE A DISQUE BRAKE DISC SYSTEM



VOLVO FL SERIE

FL4.06; FL4.08; FL4.11	01.85-12.89	AV	MERITOR PF 2.58	EFR019	EFR020	2903902 FCV702		09.7322.20 93086400 FCR130A	
FL4.06; FL4.08; FL4.11	01.85-12.89	AR	MERITOR PFC 2.58	EFR027	EFR028	2903902 FCV702		09.9745.10 93128200 FCR306A	

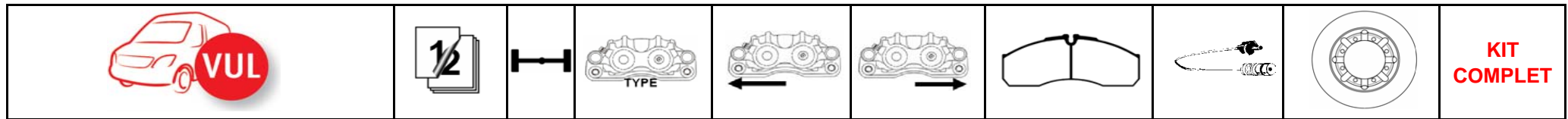
FL6 8 tonnes

FL6.07; FL6.08; FL6.09; FL6.10; FL6.11; FL6.12; FL6.13; FL6.14; FL6.15	01.88-05.00	AV	MERITOR PF 2.58	EFR019	EFR020	2903902 FCV702		09.7322.20 93086400 FCR130A	
FL6.07; FL6.08; FL6.09; FL6.10; FL6.11; FL6.12; FL6.13; FL6.14; FL6.15	01.88-05.00	AR	MERITOR PFC 2.58	EFR027	EFR028	2903902 FCV702		09.7322.20 93086400 FCR130A	
FL6.07; FL6.08; FL6.09; FL6.10; FL6.11; FL6.12; FL6.13; FL6.14; FL6.15	01.88-05.00	AV	MERITOR PF 2.68	EFR021	EFR022	2903902 FCV702		09.7322.20 93086400 FCR130A	
FL6.07; FL6.08; FL6.09; FL6.10; FL6.11; FL6.12; FL6.13; FL6.14; FL6.15	01.88-05.00	AR	MERITOR PFC 2.68	EFR029	EFR030	2903902 FCV702		09.7322.20 93086400 FCR130A	

FL6 10 tonnes

FL6.07; FL6.08; FL6.09; FL6.10; FL6.11; FL6.12; FL6.13; FL6.14; FL6.15	01.88-05.00	AV	MERITOR PF 2.58	EFR019	EFR020	2903902 FCV702		09.7322.10 93058800 FCR131A	
FL6.07; FL6.08; FL6.09; FL6.10; FL6.11; FL6.12; FL6.13; FL6.14; FL6.15	01.88-05.00	AR	MERITOR PFC 2.58	EFR027	EFR028	2903902 FCV702		09.9746.10 93086500 FCR142A	
FL6.07; FL6.08; FL6.09; FL6.10; FL6.11; FL6.12; FL6.13; FL6.14; FL6.15	01.88-05.00	AV	MERITOR PF 2.68	EFR021	EFR022	2903902 FCV702		09.7322.10 93058800 FCR131A	
FL6.07; FL6.08; FL6.09; FL6.10; FL6.11; FL6.12; FL6.13; FL6.14; FL6.15	01.88-05.00	AR	MERITOR PFC 2.68	EFR029	EFR030	2903902 FCV702		09.9746.10 93086500 FCR142A	

FREINAGE A DISQUE BRAKE DISC SYSTEM



**VOLVO ../..
FS SERIE**

FS7.16; FS7.17; FS7.18; FS7.19	10.91-	AV	MERITOR PF 2.68	EFR021	EFR022	2903902 FCV702		09.7322.10 93058800 FCR131A	
--------------------------------	--------	----	----------------------------	---------------	---------------	---------------------------	--	--	--

CABLES DE FREIN A MAIN BRAKE CABLES



REF GIL
PN GIL

QTE /
essieu

type

APPLICATIONS

L. GAINÉ

LONG.

IVECO

Daily

35.8; 35.10	01.89-05.96	CFM005	1	FAT	FL3001-FL3002	1000-1000	2500
35.8; 35.10	06.96-04.99	CFM006	1	FAM	527.5960.77- 527.5960.87- MP0558	1010-1010	2670
35.8; 35.10; 40.8; 40.10; 45.10; 49.10	06.96-04.99	CFM007	1	FAT	FL3001-FL3002	1010-1010	2770
29L10; 29L12; 29L14	1996-05.06	CFM008	2	FAD	522.7270.52- 522.7270.62	990	1330
35S9; 35S10; 35S11; 35S12; 35S13; 35S15; 35S17	1996-05.06	CFM008	2	FAD	522.7270.52- 522.7270.62	990	1330
35C10; 35C12; 35C15; 35C17; 50C13; 50C15	05.99-05.06	CFM009	2	FAM	527.5960.77- 527.5960.87- MP0558	1010	1330
29L10; 29L12; 29L14	06.06-	CFM010	2	FAD	522.7270.52- 522.7270.62	1090	1430
35S9; 35S10; 35S11; 35S12; 35S13; 35S15; 35S17	06.06-	CFM010	2	FAD	522.7270.52- 522.7270.62	1090	1430
35C10; 35C12; 35C14; 35C15; 35C17	06.06-	CFM011	2	FAD	522.9721.00- 522.9721.01	915	1230

MERCEDES

SPRINTER (906)

209 CDI; 210 CDI; 211 CDI; 213 CDI; 215 CDI; 216; 216 CDI; 218 CDI; 219 CDI; 224 (3 tonnes)	06.06-	CFM012	2	FAM	MP0655	1407	1666
309 CDI; 310 CDI; 311 CDI; 313 CDI; 315 CDI; 316; 316 CDI; 316 NGT; 318 CDI; 319 CDI; 324 (3,5 tonnes)	06.06-	CFM012	2	FAM	MP0655	1407	1666
413 CDI; 416 CDI; 419 CDI; 424 (4,6 tonnes)	06.06-	CFM012	2	FAM	MP0655	1407	1666
509 CDI; 510 CDI; 511 CDI; 513 CDI; 515 CDI; 516 CDI; 518 CDI; 519 CDI; 524 (5 tonnes) ROUE SIMPLE	06.06-	CFM013	2	FAM	MP0655	1065	1394
509 CDI; 510 CDI; 511 CDI; 513 CDI; 515 CDI; 516 CDI; 518 CDI; 519 CDI; 524 (5 tonnes) ROUE SIMPLE	03.09-	CFM014	2	FAM	MP0655	1061	1392
509 CDI; 510 CDI; 511 CDI; 513 CDI; 515 CDI; 516 CDI; 518 CDI; 519 CDI; 524 (5 tonnes) ROUE JUMEELEE	06.06-	CFM015	2	FAM	MP0678SA	1112	1432
509 CDI; 510 CDI; 511 CDI; 513 CDI; 515 CDI; 516 CDI; 518 CDI; 519 CDI; 524 (5 tonnes) ROUE JUMEELEE	03.09-	CFM016	2	FAM	MP0678SA	1102	1430

CABLES DE FREIN A MAIN BRAKE CABLES



REF GIL
PN GIL

QTE /
essieu

type

APPLICATIONS

L. GAINÉ

LONG.

NISSAN

CABSTAR E

75.28; 90.32; 110.35; 110.45; 120.35; 120.45 GAUCHE	10.98-05.01	CFM017	1		36531F3900	800	2500
75.28; 90.32; 110.35; 110.45; 120.35; 120.45 DROIT	10.98-05.01	CFM018	1		36530F3900	798	1137
75.28; 90.32; 110.35; 110.45; 120.35; 120.45 GAUCHE	06.01-12.03	CFM019	1		36531F3904	802	2055
75.28; 90.32; 110.35; 110.45; 120.35; 120.45 DROIT	06.01-12.03	CFM020	1		36530F3904	803	1190
75.28; 90.32; 110.35; 110.45; 120.35; 120.45	01.04-09.06	CFM021	2		364529X50A	905	1132
75.28; 90.32; 110.35; 110.45; 120.35; 120.45	10.00-08.07	CFM022			364529X50B- 364529X503	1048	1271

CABSTAR

28.11; 35.13; 35.15; 45.13; 45.15 GAUCHE	10.06-	CFM024	1		36531MB00B	741	898
28.11; 35.13; 35.15; 45.13; 45.15 DROIT	10.06-	CFM025	1		36530MB00B	741	898

RENAULT TRUCKS

B SERIE

B90; B110; B120	08.90-01.99	CFM003	1	FAT	KF6001	890-915	3193
-----------------	-------------	---------------	---	-----	--------	---------	------

MASCOTT

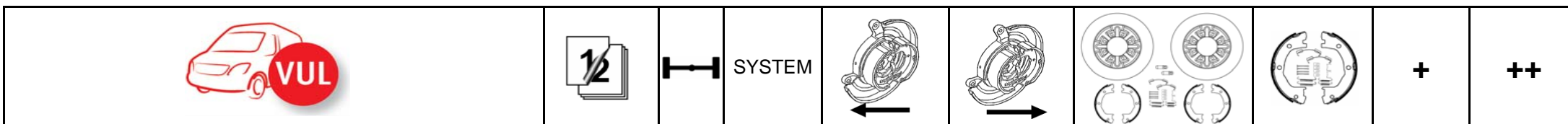
Mascott	01.99-05.04	CFM004	2	FAM	MP0558	1000	1350
Mascott DXI gauche	05.04-12.09	CFM001	1	FAM	MP0558	1050	1385
Mascott DXI droit	05.04-12.09	CFM002	1	FAM	MP0558	980	1315

VOLKSWAGEN

CRAFTER

30-35 2,0 TDI; 2,5 TDI	04.06-	CFM012	2	FAM	MP0655	1407	1666
50 2,0 TDI; 2,5 TDI ROUE SIMPLE	04.06-	CFM013	2	FAM	MP0655	1065	1394
50 2,0 TDI; 2,5 TDI ROUE JUMEELEE	04.06-	CFM015	2	FAM	MP0678SA	1112	1432

FREIN DE PARKING HANDBRAKE SYSTEM



IVECO

DAILY (96)

KA0002 (kit écrous moyeu)

35.8; 35.10; 35.12; 49.10; 49.12	01.96-06.06	AR	BREMBO	527.5960.77	527.5960.87	PK08.5952.10	MP0558	MP0558+	
----------------------------------	-------------	----	--------	--------------------	--------------------	---------------------	---------------	----------------	--

DAILY Série C

35C9; 35C11; 35C13; 50C11; 50C13; 50C15	01.96-06.06	AR	BREMBO	527.5960.77	527.5960.87	PK08.5952.10	MP0558	MP0558+	
35C17; 50C17	01.02-06.06	AR	BREMBO	527.5960.77	527.5960.87		MP0651	MP0651+	
65C11; 65C13; 65C15	01.96-	AR	BREMBO	527.7704.12	527.7704.22		MP0650SA		

MERCEDES

SPRINTER (901,902) Roues Simples

208D; 208CD I; 210D; 211CDI; 212D; 213CDI; 214; 214 NGT; 216CDI - Ch.: L874988, X304860, Z161213	02.95-	AR	ATE			PK08.7724.10	MP0574		
208D; 208CD I; 210D; 211CDI; 212D; 213CDI; 214; 214 NGT; 216CDI Ch.: L874989, X304861, Z161214 -	-05.06	AR	ATE			PK08.7724.20	MP0574		

SPRINTER (903) Roues Simples

308CDI; 308D; 310D; 311CDI; 312D; 313CDI; 314; 314 NGT; 316CDI - Ch.: L874988, X304860, Z161213	02.95-	AR	ATE			PK08.7725.10	MP0574		
308CDI; 308D; 310D; 311CDI; 312D; 313CDI; 314; 314 NGT; 316CDI Ch.: L874989, X304861, Z161214 -	-05.06	AR	ATE			PK08.7725.20	MP0574		

SPRINTER (904) Roues Jumelées

408CDI; 408D; 410D; 411CDI; 412D; 413CDI; 414; 416CDI	02.96-05.06	AR	BOSCH			PK09.8475.10	MP0594		
---	-------------	----	-------	--	--	---------------------	---------------	--	--

SPRINTER (906)

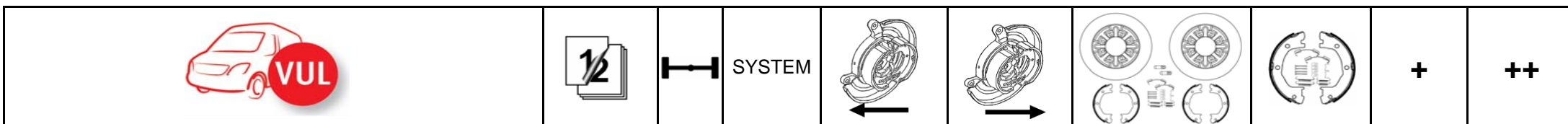
3 & 3,5 tonnes (disque Plein)	06.06-	AR	ATE			08.9509.14	MP0655		
5 tonnes (disque Ventilé)	06.06-	AR	BREMBO			09.9510.14	MP0678SA		

NISSAN

CABSTAR-ATLEON		AR	BREMBO	(527.5960.77)	(527.5960.87)	09.7263.30	MP0651	MP0651+	
----------------	--	----	--------	----------------------	----------------------	-------------------	---------------	----------------	--

+ avec régleurs **++** avec régleurs et bagues d'étanchéité

FREIN DE PARKING HANDBRAKE SYSTEM



RENAULT

MASTER II

					KA0001 (kit écrous moyeu + 32 vis)		KB0001 (bagues d'étanchéité)		
MASTER II Propulsion	01.99-	AR	BREMBO	(527.5960.77)	(527.5960.87)	PK09.7263.20	MP0558	MP0558+	MP0558++

RENAULT TRUCKS

MASCOTT 90-120

					KA0001 (kit écrous moyeu + 32 vis)		KB0001 (bagues d'étanchéité)		
3,5 > 6,0 t.	01.99-	AR	BREMBO	(527.5960.77)	(527.5960.87)	PK09.7263.20	MP0558	MP0558+	MP0558++
3,5 > 6,0 t.	01.99-	AR	BREMBO	(527.5960.77)	(527.5960.87)		MP0651	MP0651+	MP0651++

VOLKSWAGEN

LT28 Roues Simples

LT28 - Ch.: L 885 264, X 304 860	04.96-	AR	ATE			PK08.7724.10	MP0574		
LT28 Ch.: L 885 265, X 304 861 -	-03.06	AR	ATE			PK08.7724.20	MP0574		

LT35 Roues Simples

LT35 - Ch.: L 885 264, X 304 860	04.96-	AR	ATE			PK08.7725.10	MP0574		
LT35 Ch.: L 885 265, X 304 861 -	-03.06	AR	ATE			PK08.7725.20	MP0574		

LT46 Roues Jumelées

LT46	04.96-03.06	AR	BOSCH			PK09.8475.10	MP0594		
------	-------------	----	-------	--	--	---------------------	---------------	--	--

CRAFTER

3 & 3,5 tonnes (disque Plein)	04.06-	AR	ATE			08.9509.14	MP0655		
5 tonnes (disque Ventilé)	04.06-	AR	BREMBO			09.9510.14	MP0678SA		

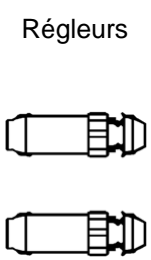
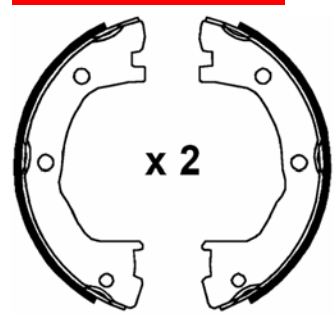
ILLUSTRATIONS / DRAWINGS

MP0558

172x42

MP0558+

MP0558++

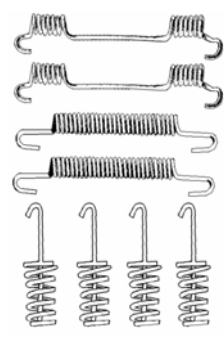
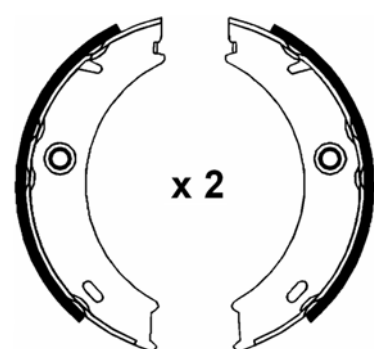
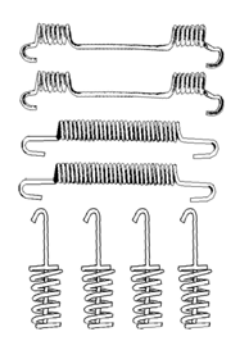
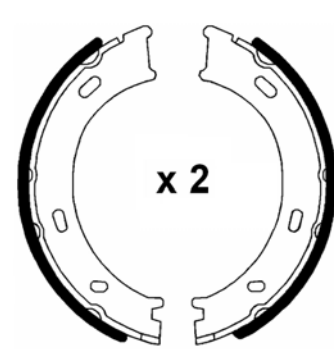


MP0574

160x40

MP0594

169x40

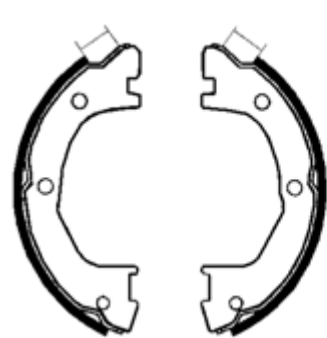
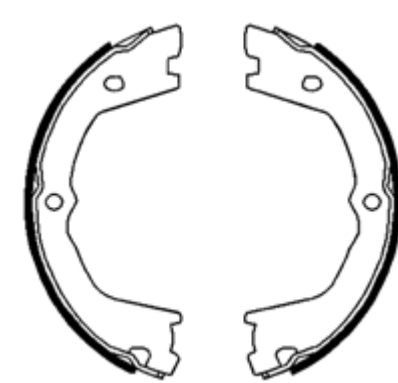


MP0650SA

190x42

MP0651

172x42

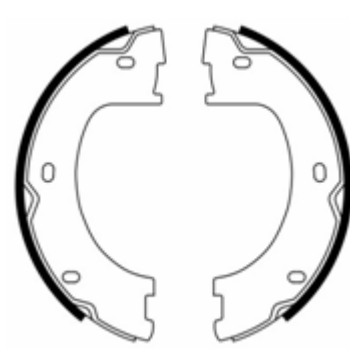
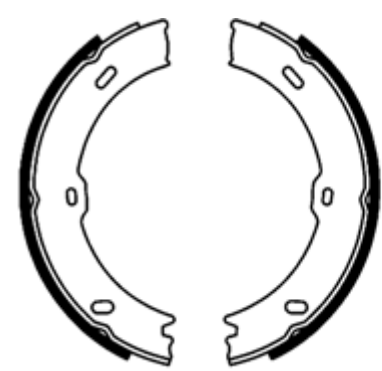


MP0655

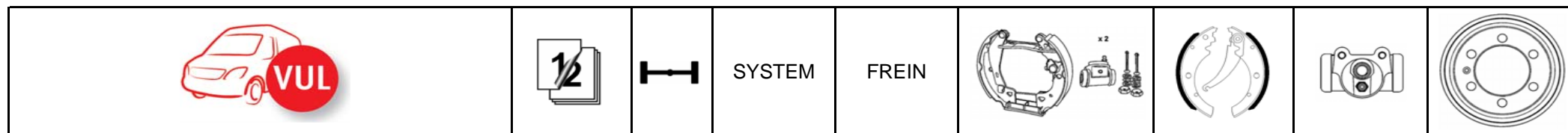
180x25

MP0678SA

172x42



FREIN A TAMBOURS BRAKE DRUM SYSTEM



DAF

SERIE FA 600 - 1100

FA600; FA800 CN	01.87-12.01	AR	PER/WAB	325x100	KF6205			
FA700		AV	BENDIX	310x100		MF0606	CR0928 CR0929	
FA700		AR	BENDIX	310x125		MF0607	CR0940 CR0941	
FA700; FA900; FA1100		AV	BENDIX	310x100		MF0606	CR0932 CR0933	
FA700; FA900; FA1100		AR	BENDIX	310x125		MF0607	CR0925 CR0926	
FA 1000; FA 1005	01.87-12.01	AR	PER/WAB	325x150	KF6206			

45 (6-8 t.)

FA 45.120, C6; FA 45.130, C6, C8; FA 45.150, C8; FA 45.160, C8	01.91-12.01	AR	PER/WAB	325x100	KF6205			
--	-------------	----	---------	---------	---------------	--	--	--

45 (8-11 t.)

FA 45.130, C9; FA 45.150, C9; FA 45.150, C11	01.91-12.01	AR	PER/WAB	325x150	KF6206			
FA 45.160, C9; FA 45.160, C11	01.91-12.01	AR	PER/WAB	325x150	KF6206			
FA 45.180, C11; FA 45.210, C11; FA 45.512	01.91-12.01	AR	PER/WAB	325x150	KF6206			

400 SERIE

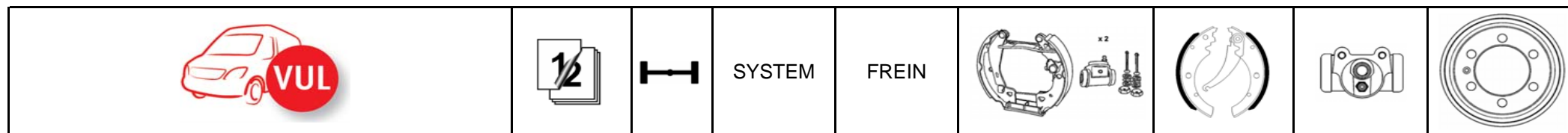
428-435 1375Kg	04.89-08.93	AR	AP	254x057		MF0407	CR1003	
428-435 1450/1500/1600Kg	04.89-08.93	AR	AP	254x070		MF0503	CR1002	

FORD

TRANSIT

TRANSIT Jantes de 16"	03.00-07.06	AR	BOSCH	280x065	KF6100	MF0564	CR0618	
TRANSIT Roues Jumelées	03.00-07.06	AR	BOSCH	280x065	KF6100	MF0564	CR0618	

FREIN A TAMBOURS BRAKE DRUM SYSTEM



IVECO DAILY

35.8; 35.9; 35.10; Roues Simples	01.79-12.96	AR	AP	254x070	KF6207	MF0503	CR1002	
35.8; 35.9; 35.10; 40.8; 40.10; 40.12; 49.12	01.79-12.96	AR	AP	254x090	FL3001/FL3002			TF0014
35.8; 35.9; 35.10; 40.8; 40.10; 40.12; 49.12	01.79-12.96	AR	AP	254x090	FL3003/FL3004	<avec TU		TF0014
35-10T; 35-12T; 40-10TW; 49-10T;49-12T	01.89-12.96	AR	PERROT	270x080	FL3207/FL3208	MF0525	CR0420	TF790065
59-12 Turbo Intercooler	01.92-12.96	AR	PERROT	310x100	FL3209/FL3210		CR1006	

ZETA

79.10; 79.12; 79;14	01.83-07.92	AV	SYRMAC	325x120			CR1007	
79.10; 79.12; 79;14	01.83-07.92	AR	SYRMAC	325x120			CR1007	

LDV

CONVOY

428-435 1375Kg	09.93-	AR	AP	254x057		MF0407	CR1003	
428-435 1450/1500/1600Kg	09.93-	AR	AP	254x070		MF0503	CR1002	

MAGIRUS

90 M6		AV	BENDIX	310x100		MF0606	CR0928 CR0929	
90 M6		AR	BENDIX	310x125		MF0607	CR0940 CR0941	
90 M8; 90 M9; 130 M9		AV	BENDIX	310x100		MF0606	CR0932 CR0933	
90 M8; 90 M9; 130 M9		AR	BENDIX	310x125		MF0607	CR0925 CR0926	

MERCEDES




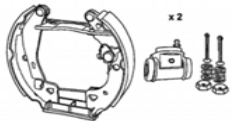


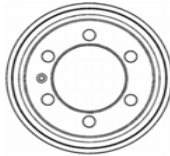
T1 (601)

207 D; 208 D; 209 D; 210; 210 D	05.77-02.96	AR	PERROT	230x035	KF6200	MF0572	CR0581	TF0220
---------------------------------	-------------	----	--------	---------	---------------	---------------	---------------	---------------

T1 (602)

307 D; 308 D; 309 D; 310 D	10.82-02.96	AR	PERROT	260x055	KF6201		CR0581	TF0221
----------------------------	-------------	----	--------	---------	---------------	--	---------------	---------------

FREIN A TAMBOURS BRAKE DRUM SYSTEM

			SYSTEM	FREIN				
---	---	---	--------	-------	---	---	---	---

MERCEDES ../.

T1/T2

407 D; 408 D; 409 D; 410; 410 D; 507 D; 508 D; 510	07.81-06.95	AR	PERROT	270x080	KF6202	MF0525	CR0748	
--	-------------	----	--------	---------	---------------	---------------	---------------	--

NISSAN

CABSTAR E

75.28; 90.32; 110.35; 110.45; 120.35; 120.45 Roues de 16"	10.98-10.06	AR	BOSCH	280x065	KF6100	MF0564	CR0618	TF790476
---	-------------	----	-------	---------	---------------	---------------	---------------	-----------------

PIAGGIO

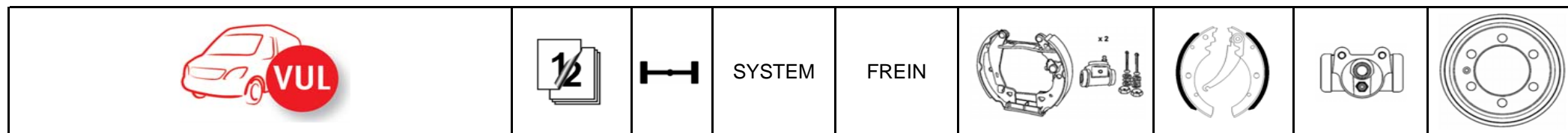
PORTER MAXI	01.95-	AR	AP	254x057	FL5010-FL5011			
-------------	--------	----	----	---------	----------------------	--	--	--

RENAULT TRUCKS

BERLIET

10K; 20K; 30K		AV	BENDIX	355x100		MF0611	CR0529	
10K; 20K; 30K		AR	BENDIX	355x100		MF0611	CR0549	
90B6/7		AV	BENDIX	310x100		MF0606	CR0928 CR0929	
90B6/7		AR	BENDIX	310x125		MF0607	CR0940 CR0941	
90B8/9		AV	BENDIX	310x100		MF0606	CR0932 CR0933	
90B8/9; 130B6/9		AR	BENDIX	310x125		MF0607	CR0925 CR0926	
130B11		AV	BENDIX	310x100		MF0606	CR0539	
130B11		AR	BENDIX	325x150		MF0609	CR0546	
560K6; 610K6		AV	BENDIX	325x120		MF0608	CR0571	
560K6; 610K6		AR	BENDIX	325x120		MF0608	CR0677 CR0678	
600KB; 620KB; 680KB; 770K; 770KB; 771K; 771KB		AV	BENDIX	355x100		MF0611		
600KB; 620KB; 680KB; 770K; 770KB; 771K; 771KB		AR	BENDIX	355x100		MF0611		

FREIN A TAMBOURS BRAKE DRUM SYSTEM



RENAULT TRUCKS ../.

SAVIEM

SB2		AV	BENDIX	310x080		MF0605	CRB190(4)	
SB2		AR	BENDIX	305x070		MF0603	CR0690	
SG2	01.70-	AV	BENDIX	305x080		MF0604	CRB157(4)	
SG2	01.70-	AR	BENDIX	305x045		MF0600	CR0549 CR0550	
SG3	01.73-	AV	BENDIX	310x080		MF0605	CRB190(4)	
SG3	01.73-12.89	AR	BENDIX	305x070		MF0603	CR0690	
SG4 1969-		AV	BENDIX	356x050			CR0366	
SG4 1969-		AR	BENDIX	360x075		MF0612	CR0367	
SG5		AV	BENDIX				CRB143(2) CRB144(2)	
SG5		AR	BENDIX				CRB143(2) CRB147(2)	
SG5 C		AV	BENDIX				CR0366	
SG5 C		AR	BENDIX				CR0367	

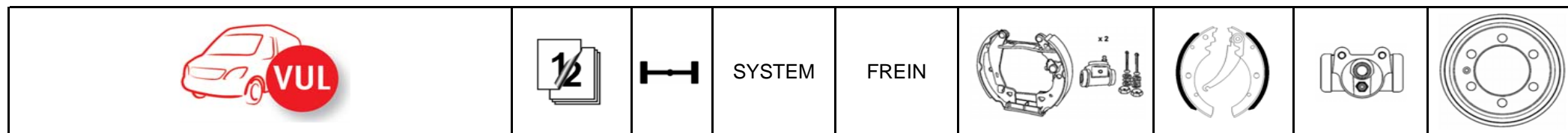
B SERIE

B70; B80	01.82-12.90	AR	BENDIX	305x070	KF6002	MF0602	CR0827	
B90; B110; B120	10.92-1999	AR	BENDIX	305x080	KF6001	MF0601	CR0896	TF6806
B90; B110; B120	10.92-1999	AR	BENDIX	305x080	FL3105/FL3106		CR0896	TF6806

J SERIE

JK		AV	BENDIX	310x100		MF0606	CR0928 CR0929	
JK		AR	BENDIX	310x125		MF0607	CR0940 CR0941	
JN		AV	BENDIX	325x120		MF0608	CR0932 CR0933	
JN		AR	BENDIX	325x150		MF0609	CR0925 CR0926	
JP		AV	BENDIX	355x100		MF0611	CR0539	
JP		AR	BENDIX	355x100		MF0611	CR0546	

FREIN A TAMBOURS BRAKE DRUM SYSTEM



RENAULT TRUCKS ../.

S SERIE

S110; S130 (6x6 SINPAR)		AV	BENDIX	355x100		MF0611	CR0529	
S110; S130 (6x6 SINPAR)		AR	BENDIX	355x100		MF0611	CR0541	
S130-11; S130-13; S130-14; avec pont P620		AV	BENDIX	355x100		MF0611	CR0546	
S150-11; S150-13; S150-14; avec pont P620		AR	BENDIX	355x100		MF0611	CR0546	
S5; SM5		AV	BENDIX	355x100		MF0611	CR0526	
S5; SM5		AR	BENDIX	355x100		MF0611	CR0527	
SM6		AV	BENDIX	355x100		MF0611	CR0342	
SM6		AR	BENDIX	355x100		MF0611	CR0351	
S90; S100; S130; S150	11.86-	AV	BENDIX	325x120		MF0608	CR0934 CR0935	
S90; S100; S130; S150	11.86-	AR	BENDIX	325x150		MF0609	CR0925 CR0926	
S110	11.86-	AV	BENDIX	325x120		MF0608	CR0930 CR0931	
S110	11.86-	AR	BENDIX	325x150		MF0609	CR0891	
S110; S130 6x6	11.86-	AV	BENDIX	325x120		MF0608	CR0529	
S110; S130 6x6	11.86-	AR	BENDIX	325x150		MF0609	CR0541	
S130; S150 (PONT 620)	11.86-	AR	BENDIX	325x150		MF0609	CR0891	

VOLVO

SERIE F406/609

F406		AV	BENDIX	310x100		MF0606	CR0928 CR0929	
F406		AR	BENDIX	310x125		MF0607	CR0940 CR0941	
F609		AV	BENDIX	325x120		MF0608	CR0932 CR0933	
F609		AR	BENDIX	325x150		MF0609	CR0925 CR0926	

CORRESPONDANCE DES REFERENCES CROSS LIST

MARQUE/MAKER	REF/PN OES	REF/PN
BENDIX	B355982NA	MF0601
CITROËN	1607376880	522.8142.45
CITROËN	1607376980	522.8142.42
CITROËN	1607377880	522.8142.46
CITROËN	1606400780	09.8932.10
CITROËN	1606400780	92116703
CITROËN	1606400780	DDF768C
CITROËN	1606401680	09.8932.10
CITROËN	1606401680	92116703
CITROËN	1606401680	DDF768C
CITROËN	1607376880	522.8142.32
CITROËN	1607376980	522.8142.55
CITROËN	1607377980	522.8142.56
CITROËN	1607378080	522.8148.45
CITROËN	1607378180	522.8148.55
CITROËN	1607378280	522.8148.46
CITROËN	1607378380	522.8148.56
CITROËN	1607872080	09.8931.20
CITROËN	1607872080	92275103
CITROËN	1607872080	DDF1170C
CITROËN	1607872280	09.8932.10
CITROËN	1607872280	92116703
CITROËN	1607872280	DDF768C
CITROËN	1607880480	08.8094.30
CITROËN	1607880480	92116103
CITROËN	1607880480	DDF1144C
CITROËN	1607880580	08.8094.40
CITROËN	1607880580	92116203
CITROËN	1607880580	DDF1145
CITROËN	1611457780	2392101
CITROËN	1611457780	FVR1480
CITROËN	1611841680	09.8932.10
CITROËN	1611841680	92116703
CITROËN	1611841680	DDF768C
CITROËN	4241N5	91066700
CITROËN	4246K2	09.8932.10
CITROËN	4246K2	92116703
CITROËN	4246K2	DDF768C
CITROËN	4246K3	09.8932.10
CITROËN	4246K3	92116703
CITROËN	4246K3	DDF768C
CITROËN	4246L2	09.8931.20
CITROËN	4246L2	92275103
CITROËN	4246L2	DDF1170C
CITROËN	4246L3	09.8931.20
CITROËN	4246L3	92275103
CITROËN	4246L3	DDF1170C
CITROËN	4246L4	09.8931.20
CITROËN	4246L4	92275103
CITROËN	4246L4	DDF1170C
CITROËN	4246X9	09.8931.20
CITROËN	4246X9	92275103
CITROËN	4246X9	DDF1170C
CITROËN	4246Y1	09.8931.20
CITROËN	4246Y1	92275103

MARQUE/MAKER	REF/PN OES	REF/PN
CITROËN	4246Y1	DDF1170C
CITROËN	4246Y3	09.8932.10
CITROËN	4246Y3	92116703
CITROËN	4246Y3	DDF768C
CITROËN	4246Y5	09.8932.10
CITROËN	4246Y5	92116703
CITROËN	4246Y5	DDF768C
CITROËN	4246Y7	08.8094.30
CITROËN	4246Y7	92116103
CITROËN	4246Y7	DDF1144C
CITROËN	4246Z1	08.8094.40
CITROËN	4246Z1	92116203
CITROËN	4246Z1	DDF1145
CITROËN	424900	09.8931.20
CITROËN	424900	92275103
CITROËN	424900	DDF1170C
CITROËN	4249000	09.8932.10
CITROËN	4249000	92116703
CITROËN	4249000	DDF768C
CITROËN	424926	09.8931.20
CITROËN	424926	92275103
CITROËN	424926	DDF1170C
CITROËN	424927	09.8931.20
CITROËN	424927	92275103
CITROËN	424927	DDF1170C
CITROËN	424935	09.8932.10
CITROËN	424935	92116703
CITROËN	424935	DDF768C
CITROËN	424936	09.8932.10
CITROËN	424936	92116703
CITROËN	424936	DDF768C
CITROËN	424999	09.8931.20
CITROËN	424999	92275103
CITROËN	424999	DDF1170C
CITROËN	4249A0	09.8932.10
CITROËN	4249A0	92116703
CITROËN	4249A0	DDF768C
CITROËN	4249G3	09.8931.20
CITROËN	4249G3	92275103
CITROËN	4249G3	DDF1170C
CITROËN	4249G5	09.8932.10
CITROËN	4249G5	92116703
CITROËN	4249G5	DDF768C
CITROËN	4249H2	09.8932.10
CITROËN	4249H2	92116703
CITROËN	4249H2	DDF768C
CITROËN	4249H8	09.8931.20
CITROËN	4249H8	92275103
CITROËN	4249H8	DDF1170C
CITROËN	4249H9	09.8932.10
CITROËN	4249H9	92116703
CITROËN	4249H9	DDF768C
CITROËN	4249K3	09.8931.20
CITROËN	4249K3	92275103
CITROËN	4249K3	DDF1170C

Les correspondances de références ont pour seul but la recherche de références;

The cross references are intended only to seek references;

CORRESPONDANCE DES REFERENCES CROSS LIST

MARQUE/MAKER	REF/PN OES	REF/PN
CITROËN	4249K7	08.8094.30
CITROËN	4249K7	92116103
CITROËN	4249K7	DDF1144C
CITROËN	4249K8	08.8094.40
CITROËN	4249K8	92116203
CITROËN	4249K8	DDF1145
CITROËN	425242	2391701
CITROËN	425242	FVR1478
CITROËN	425243	2391701
CITROËN	425243	FVR1478
CITROËN	425244	2391901
CITROËN	425244	FVR1479
CITROËN	425245	2391901
CITROËN	425245	FVR1479
CITROËN	425246	2392101
CITROËN	425246	FVR1480
CITROËN	425247	2392101
CITROËN	425247	FVR1480
CITROËN	425458	2391701
CITROËN	425458	FVR1478
CITROËN	425459	2391901
CITROËN	425459	FVR1479
CITROËN	425468	2392101
CITROËN	425468	FVR1480
CITROËN	44010000	522.8142.32
CITROËN	4401E4	522.8142.45
CITROËN	4401E5	522.8142.42
CITROËN	4401E5	522.8142.55
CITROËN	4401E6	522.8142.46
CITROËN	4401E7	522.8142.56
CITROËN	4401E8	522.8148.45
CITROËN	4401E9	522.8148.55
CITROËN	4401F2	522.8153.12
CITROËN	4401F3	522.8153.22
CITROËN	4401H8	522.8142.46
CITROËN	4401H9	522.8142.56
CITROËN	4401J0	522.8148.45
CITROËN	4401J1	522.8148.55
CITROËN	4401J2	522.8148.46
CITROËN	4401J3	522.8148.56
CITROËN	4401L6	522.8142.32
CITROËN	4401L6	522.8142.45
CITROËN	4401L7	522.8142.42
CITROËN	4401L7	522.8142.55
CITROËN	453583	MC0110
CITROËN	46806233	09.8931.20
CITROËN	46806233	92275103
CITROËN	46806233	DDF1170C
CITROËN	46806234	09.8932.10
CITROËN	46806234	92116703
CITROËN	46806234	DDF768C
CITROËN	4949H2	09.8932.10
CITROËN	4949H2	92116703
CITROËN	4949H2	DDF768C
CITROËN	51728378	09.8932.10

MARQUE/MAKER	REF/PN OES	REF/PN
CITROËN	51728378	92116703
CITROËN	51728378	DDF768C
CITROËN	5416277	09.3059.10
CITROËN	7531819	08.3069.14
CITROËN	7568440	08.3069.14
CITROËN	95609790	EFR148
CITROËN	95609791	EFR149
CITROËN	ZF04450931	08.4478.10
CITROËN	ZF07545170	MC0110
CITROËN	ZF07568501	08.4478.10
CITROËN	ZF07713643	MC0110
DAF	0192719	MC0621
DAF	0759509	MC0622
DAF	0759512	EFR064
DAF	0759513	EFR063
DAF	0759704	CR1003
DAF	1203032	EFR040
DAF	1203033	EFR039
DAF	1518571	EFR039
DAF	1518572	EFR040
DAF	1522108	EFR045
DAF	607991	CR0925
DAF	607991	CR0936
DAF	607992	CR0926
DAF	607992	CR0937
DAF	607994	CR0933
DAF	608422	CR0928
DAF	608423	CR0929
DAF	608424	CR0940
DAF	608425	CR0941
DAF	699152	CR0928
DAF	699153	CR0929
DAF	699154	CR0932
DAF	699155	CR0933
DAF	699156	CR0940
DAF	699157	CR0941
DAF	699158	CR0925
DAF	699158	CR0936
DAF	699159	CR0926
DAF	699159	CR0937
DAF	91112875	MF0503
DAF	ACU9383	EFR041
DAF	ACU9384	EFR042
DAF	AMPB887	09.7323.10
DAF	AMPB887	93084200
DAF	AMPB887	FCR102A
DAF	AMPB889	09.5797.10
DAF	AMPB889	93084100
DAF	AMPB889	FCR101A
DAF	BAU2257	EFR062
DAF	BAU2258	EFR061
DAF	BBU8177	2901704
DAF	BBU8177	FCV503
DAF	CAP5102	EFR062
DAF	CAP5103	EFR061

Les correspondances de références ont pour seul but la recherche de références;

The cross references are intended only to seek references;

CORRESPONDANCE DES REFERENCES CROSS LIST

MARQUE/MAKER	REF/PN OES	REF/PN
DAF	GWC1149	CR1002
DAF	MAK2487	09.7323.10
DAF	MAK2487	93084200
DAF	MAK2487	FCR102A
DAF	MAK2578	09.7323.10
DAF	MAK2578	93084200
DAF	MAK2578	FCR102A
DAF	MAK7429	09.5797.10
DAF	MAK7429	93084100
DAF	MAK7429	FCR101A
DAF	MAK7529	09.5797.10
DAF	MAK7529	93084100
DAF	MAK7529	FCR101A
DAF	PAK3545	09.5797.10
DAF	PAK3545	09.7323.10
DAF	PAK3545	93084100
DAF	PAK3545	93084200
DAF	PAK3545	FCR101A
DAF	PAK3545	FCR102A
DAF	PAK3546	09.7323.10
DAF	PAK3546	93084200
DAF	PAK3546	DF713685
DAF	PAK3546	FCR102A
DAF	PAK5412	09.5797.10
DAF	PAK5412	93084100
DAF	PAK5412	FCR101A
DAF	PAK5513	09.7323.10
DAF	PAK5513	93084200
DAF	PAK5513	FCR102A
DAF	RAK5513	09.7323.10
DAF	RAK5513	93084200
DAF	RAK5513	FCR102A
DAF	RAK7404	09.5797.10
DAF	RAK7404	93084100
DAF	RAK7404	FCR101A
DAF	RTC3348	2090401
DAF	RTC3348	FVR836
DAF	RTC3624	CR1002
DAF	RTC4812	2035908
DAF	RTC4812	FVR829
DAF	SA4107754	2035908
DAF	SA4107754	FVR829
DAF	SR3157755	MF0407
EVOBUS	8282192000	MC0630
EVOBUS	8282192100	MC0630
EVOBUS	8282192200	MC0630
EVOBUS	8285388451	98022000
FAUN	1619314	MC0630
FERODO	DDF1203C	93123403
FERODO	DDF1234C	93123503
FERODO	DDF1623	92153703
FERODO	DDF1623-1	92153700
FERODO	DDF1974C-1	92228600
FERODO	DF1372	93185303
FERODO	FAI100	98022200

MARQUE/MAKER	REF/PN OES	REF/PN
FERODO	FAI102	98021302
FERODO	FAI103	98012200
FERODO	FAI103	98022000
FERODO	FAI106	98022300
FERODO	FAI115	98024800
FERODO	FAI155	98028500
FERODO	FAI176	98028400
FERODO	FAI177	507.9308.62
FERODO	FCR142A	93086500
FERODO	FCR195A	08.7300.10
FERODO	FCR195A	93104700
FERODO	FCR196A	08.7300.20
FERODO	FCR196A	93104800
FERODO	FCR228A	92131503
FERODO	FCR261A	09.B497.10
FERODO	FCR264A	09.8495.10
FERODO	FCR306A	93128200
FERODO	FCR361A	09.A922.14
FERODO	FCV1126	507.5901.21
FERODO	FCV1126	507.5901.30
FERODO	FCV376	2901703
FERODO	FCV4254	507.9814.11
FERODO	FCV4254	507.9814.21
FERODO	FCV702	2903902
FERODO	FCV733	507.5664.31
FERODO	FCV961	2968801
FERODO	FCV983	2901602
FERODO	FSB4001	91066800
FERODO	FSB4001	MP0655
FERODO	FSB4103	91069000
FERODO	FSB4103	MP0678SA
FERODO	FSB593	91059000
FERODO	FSB624	91055100
FERODO	FSB624	MP0574
FERODO	FSB625	91057900
FERODO	FSB625	MP0594
FERODO	FSB658	MP0650SA
FERODO	FSB685	MP0651
FERODO	FSL4053	507.9703.16
FERODO	FVR1102	507.5944.11
FERODO	FVR1304	2302201
FERODO	FVR1701	2350101
FERODO	FVR4037	507.9724.10
FERODO	FVR4039	507.9786.10
FERODO	FVR4053	507.9703.16
FERODO	FVR4251	2912307
FERODO	FVR4315	2923801
FERODO	FWI278	98031700
FERODO	FWI294	98033700
FERODO	FWI299	98040900
FERODO	FWI303	98040700
FERODO	FWI305	98040800
FERODO	FWI306	98042200
FERODO	FWI311	98033800
FIAT	1300500080	08.5905.14

Les correspondances de références ont pour seul but la recherche de références;

The cross references are intended only to seek references;

CORRESPONDANCE DES REFERENCES CROSS LIST

MARQUE/MAKER	REF/PN OES	REF/PN
FIAT	1300501080	09.5904.14
FIAT	1300501080	09.8931.20
FIAT	1300501080	92275103
FIAT	1300501080	DDF1170C
FIAT	1307356080	09.5906.14
FIAT	1307356080	09.8932.10
FIAT	1307356080	92116703
FIAT	1307356080	DDF768C
FIAT	1341044080	09.8931.20
FIAT	1341044080	92275103
FIAT	1341044080	DDF1170C
FIAT	1341045080	09.8932.10
FIAT	1341045080	92116703
FIAT	1341045080	DDF768C
FIAT	1341046080	08.8094.30
FIAT	1341046080	92116103
FIAT	1341046080	DDF1144C
FIAT	4450931	08.4478.10
FIAT	46806233	09.8931.20
FIAT	46806233	92275103
FIAT	46806233	DDF1170C
FIAT	46806234	09.8932.10
FIAT	46806234	92116703
FIAT	46806234	DDF768C
FIAT	46833806	08.8094.30
FIAT	46833806	92116103
FIAT	46833806	DDF1144C
FIAT	46833807	08.8094.40
FIAT	46833807	92116203
FIAT	46833807	DDF1145
FIAT	51728377	09.8931.20
FIAT	51728377	92275103
FIAT	51728377	DDF1170C
FIAT	51728378	09.8932.10
FIAT	51728378	92116703
FIAT	51728378	DDF768C
FIAT	51740244	09.8931.20
FIAT	51740244	92275103
FIAT	51740244	DDF1170C
FIAT	51740247	09.8932.10
FIAT	51740247	92116703
FIAT	51740247	DDF768C
FIAT	51848616	08.8094.30
FIAT	51848616	92116103
FIAT	51848616	DDF1144C
FIAT	51848617	08.8094.30
FIAT	51848617	92116103
FIAT	51848617	DDF1144C
FIAT	51848618	09.8931.20
FIAT	51848618	92275103
FIAT	51848618	DDF1170C
FIAT	51848619	09.8931.20
FIAT	51848619	92275103
FIAT	51848619	DDF1170C
FIAT	51856411	08.8094.40

MARQUE/MAKER	REF/PN OES	REF/PN
FIAT	51856411	92116203
FIAT	51856411	DDF1145
FIAT	51856412	08.8094.40
FIAT	51856412	92116203
FIAT	51856412	DDF1145
FIAT	51858362	09.8932.10
FIAT	51858362	92116703
FIAT	51858362	DDF768C
FIAT	51858363	09.8932.10
FIAT	51858363	92116703
FIAT	51858363	DDF768C
FIAT	5426184	08.3030.10
FIAT	6000619994	92268803
FIAT	6000620046	2208701
FIAT	6000620046	FVR4840
FIAT	6000620052	2398001
FIAT	6000620052	FVR1516
FIAT	60738494	MC0092
FIAT	71738905	09.8931.20
FIAT	71738905	92275103
FIAT	71738905	DDF1170C
FIAT	71738910	08.5905.14
FIAT	71739637	09.8932.10
FIAT	71739637	92116703
FIAT	71739637	DDF768C
FIAT	71739638	08.3136.14
FIAT	71752978	2391901
FIAT	71752978	FVR1479
FIAT	71752979	2391701
FIAT	71752979	FVR1478
FIAT	71752985	2392101
FIAT	71752985	FVR1480
FIAT	71772525	2391901
FIAT	71772525	FVR1479
FIAT	71772526	2391701
FIAT	71772526	FVR1478
FIAT	71772527	2392101
FIAT	71772527	FVR1480
FIAT	71772817	09.8931.20
FIAT	71772817	2391701
FIAT	71772817	92275103
FIAT	71772817	DDF1170C
FIAT	71772817	FVR1478
FIAT	735289101	522.8142.32
FIAT	735289101	522.8142.45
FIAT	735289102	522.8142.42
FIAT	735289102	522.8142.55
FIAT	735289103	522.8142.46
FIAT	735289104	522.8142.56
FIAT	735289105	522.8148.45
FIAT	735289106	522.8148.55
FIAT	735289107	522.8148.46
FIAT	735289108	522.8148.56
FIAT	735289109	522.8153.12
FIAT	735289110	522.8153.22

Les correspondances de références ont pour seul but la recherche de références;

The cross references are intended only to seek references;

CORRESPONDANCE DES REFERENCES CROSS LIST

MARQUE/MAKER	REF/PN OES	REF/PN
FIAT	735361976	522.8142.32
FIAT	735361976	522.8142.45
FIAT	735361977	522.8142.42
FIAT	735361977	522.8142.55
FIAT	735361978	522.8142.46
FIAT	735361979	522.8142.56
FIAT	735361980	522.8148.45
FIAT	735361981	522.8148.55
FIAT	735361982	522.8148.46
FIAT	735361983	522.8148.56
FIAT	735433315	522.8142.42
FIAT	7538682	08.3136.14
FIAT	7545170	MC0110
FIAT	7568501	08.4478.10
FIAT	7713643	MC0110
FIAT	77362216	2391901
FIAT	77362216	FVR1479
FIAT	77362219	2391701
FIAT	77362219	FVR1478
FIAT	77362274	2392101
FIAT	77362274	FVR1480
FIAT	77362697	522.8142.32
FIAT	77362697	522.8142.45
FIAT	77362698	522.8142.42
FIAT	77362698	522.8142.55
FIAT	77362702	522.8142.46
FIAT	77362703	522.8142.56
FIAT	77362704	522.8148.45
FIAT	77362705	522.8148.55
FIAT	77362706	522.8148.46
FIAT	77362707	522.8148.56
FIAT	77364023	91066700
FIAT	77364451	522.8153.12
FIAT	77364452	522.8153.22
FIAT	77364454	522.8142.32
FIAT	77364454	522.8142.45
FIAT	77364455	522.8142.42
FIAT	77364455	522.8142.55
FIAT	77364456	522.8142.46
FIAT	77364457	522.8142.56
FIAT	77364459	522.8148.45
FIAT	77364460	522.8148.55
FIAT	77364461	522.8148.46
FIAT	77364462	522.8148.56
FIAT	77364859	2391901
FIAT	77364859	FVR1479
FIAT	77364860	2392101
FIAT	77364860	FVR1480
FIAT	77364862	2391701
FIAT	77364862	FVR1478
FIAT	93500520	08.3069.14
FIAT	93500521	08.3136.14
FIAT	9939698	EFR148
FIAT	9939699	EFR149
FIAT	9949362	2391901

MARQUE/MAKER	REF/PN OES	REF/PN
FIAT	9949362	FVR1479
FIAT	9949407	2392101
FIAT	9949407	FVR1480
FIAT	9949408	2392101
FIAT	9949408	FVR1480
FIAT	9949409	2391701
FIAT	9949409	FVR1478
FIAT	9949413	522.8142.32
FIAT	9949413	522.8142.45
FIAT	9949414	522.8142.42
FIAT	9949414	522.8142.55
FIAT	9949415	522.8142.46
FIAT	9949416	522.8142.56
FIAT	9949421	522.8148.45
FIAT	9949422	522.8148.55
FIAT	9949423	522.8148.46
FIAT	9949424	522.8148.56
FIAT	9949427	522.8153.12
FIAT	9949428	522.8153.22
FIAT	9949482	2391701
FIAT	9949482	FVR1478
FIAT	9949516	2391701
FIAT	9949516	FVR1478
FIAT	9949517	2391901
FIAT	9949517	FVR1479
FORD	4830047	EFR167
FORD	1227046	MF0564
FORD	1501265	2912307
FORD	1539549	08.3637.10
FORD	1560029	CR1003
FORD	1564842	09.2943.10
FORD	1660384	2903902
FORD	1660384	FCV702
FORD	1668048	EFR145
FORD	1668049	EFR144
FORD	1668050	EFR101
FORD	1668051	EFR100
FORD	1668053	2903902
FORD	1668053	FCV702
FORD	1718023	2912307
FORD	4041427	09.8960.10
FORD	4041428	09.8837.14
FORD	4055724	MF0564
FORD	4055730	CR0618
FORD	4055819	EFR080
FORD	4055820	EFR079
FORD	4143208	MF0564
FORD	4455986	MF0564
FORD	4525732	MF0564
FORD	4743576	MF0564
FORD	4830046	EFR166
FORD	4841295	KF6100
FORD	5022674	08.3637.10
FORD	5022675	09.2943.10
FORD	5022676	08.5013.10

Les correspondances de références ont pour seul but la recherche de références;

The cross references are intended only to seek references;

CORRESPONDANCE DES REFERENCES CROSS LIST

MARQUE/MAKER	REF/PN OES	REF/PN
FORD	5022677	08.3637.10
FORD	5025610	09.6967.14
FORD	5025611	09.6959.10
FORD	5029815	09.6967.14
FORD	5029816	09.6959.10
FORD	6041696	08.3637.10
FORD	6166055	08.5013.10
FORD	6166056	08.3637.10
FORD	6204677	2903902
FORD	6204677	FCV702
FORD	6464706	CR0618
FORD	70VB2261CB	CR1003
FORD	8C1V2M008AA	2912307
FORD	8C1V2M008AB	2912307
FORD	8C1V2MM008AA	2912307
FORD	92VB2261CA	CR0618
FORD	R87DB2552A	EFR145
FORD	R87DB2552AA	EFR145
FORD	R87DB2552BA	EFR101
FORD	R87DB2553A	EFR144
FORD	R87DB2553AA	EFR144
FORD	R87DB2553BA	EFR100
FORD	YC152200AA	MF0564
FORD	YC152200AC	MF0564
FORD	YC152200AD	MF0564
FORD	YC152261AA	CR0618
FORD	YC152B120AA	EFR080
FORD	YC152B121AA	EFR079
FORD	YC152B256AF	KF6100
HANOMAG	1085201	MC0630
HANOMAG	X860085201000	MC0630
IRISBUS	2996535	2912112
IRISBUS	2996535	507.5944.11
IRISBUS	2996535	FVR1102
IRISBUS	5000814345	2904402
IRISBUS	5000814345	FCV1940
IRISBUS	5001823557	2904402
IRISBUS	5001823557	FCV1940
ISUZU	586116486	2926101
ISUZU	586122926	2926101
ISUZU	586124985	2926101
ISUZU	1K003323ZA	FCV5000B
ISUZU	1K003323ZA	PF1235
ISUZU	1K043323Z	FCV1853
ISUZU	1K043323Z	PF1236
ISUZU	4103089TA0	FCV5000B
ISUZU	4103089TA0	PF1235
ISUZU	4106089TB6	FCV5000B
ISUZU	4106089TB6	PF1235
ISUZU	4106089TC1	FCV1853
ISUZU	4106089TC1	PF1236
ISUZU	4106089TC8	FCV5000B
ISUZU	4106089TC8	PF1235
ISUZU	4106089TD4	FCV5000B
ISUZU	4106089TD4	PF1235

MARQUE/MAKER	REF/PN OES	REF/PN
ISUZU	5867500810	FCV5000B
ISUZU	5867500810	PF1235
ISUZU	8970429331	91076100
ISUZU	897168631	DF6392
ISUZU	897168632	DF6393
ISUZU	8971686321	DF6393
ISUZU	8971686330	FCV5000B
ISUZU	8971686330	PF1235
ISUZU	8971686340	FCV1853
ISUZU	8971686340	FCV5000B
ISUZU	8971686340	PF1235
ISUZU	8971686340	PF1236
ISUZU	8971807020	91076100
ISUZU	8973211020	FCV5000B
ISUZU	8973211020	PF1235
ISUZU	8973292660	FCV5000B
ISUZU	8973292660	PF1235
ISUZU	8973496890	CRB601
ISUZU	8973496900	CRB602
ISUZU	8973496910	CRB603
ISUZU	8973496920	CRB604
ISUZU	8973588780	CRB605
ISUZU	8973588790	CRB606
ISUZU	8973588800	CRB607
ISUZU	8973588810	CRB608
ISUZU	8973659070	EFR084
ISUZU	8973659080	EFR083
ISUZU	8973659110	FCV5000B
ISUZU	8973659110	PF1235
ISUZU	8973675390	PF1580
ISUZU	897371860	DF6392
ISUZU	897371877	DF6393
ISUZU	8973718770	DF6393
ISUZU	8973775220	FCV5000B
ISUZU	8973775220	PF1235
ISUZU	8973783510	PF1580
ISUZU	8973784460	FCV1853
ISUZU	8973784460	FCV5000B
ISUZU	8973784460	PF1235
ISUZU	8973784460	PF1236
ISUZU	8973872280	DF6393
ISUZU	8973872290	DF6392
ISUZU	8980212710	PF1580
ISUZU	8980912710	PF1580
ISUZU	8981050580	DF6393
ISUZU	898216921	FCV5000B
ISUZU	898216921	PF1235
ISUZU	8982169210	PF1580
ISUZU	8982169220	FCV5000B
ISUZU	8982169220	PF1235
ISUZU	8982169260	FCV1853
ISUZU	8982169260	PF1236
ISUZU	8982447940	FCV1853
ISUZU	8982447940	PF1236
ISUZU	8982488950	DF6393

Les correspondances de références ont pour seul but la recherche de références;

The cross references are intended only to seek references;

CORRESPONDANCE DES REFERENCES CROSS LIST

MARQUE/MAKER	REF/PN OES	REF/PN
ISUZU	97168633	FCV5000B
ISUZU	97168633	PF1235
ISUZU	AKNS208HEF	FCV1853
ISUZU	AKNS208HEF	PF1236
IVECO	050289	MC0235
IVECO	1522201	2906504
IVECO	1522201	FCV879
IVECO	1560032	CR1002
IVECO	1902294	2035907
IVECO	1902294	FVR839
IVECO	1902301	2118801
IVECO	1902301	507.4146.51
IVECO	1902301	FVR511
IVECO	1902469	2903701
IVECO	1902469	507.4146.49
IVECO	1902469	FVR713
IVECO	1902493	2118801
IVECO	1902493	507.4146.51
IVECO	1902493	FVR511
IVECO	1903383	507.4146.58
IVECO	1903486	2901704
IVECO	1903486	FCV503
IVECO	1903488	2118801
IVECO	1903488	507.4146.51
IVECO	1903488	FVR511
IVECO	1904528	08.5374.10
IVECO	1904528	93084400
IVECO	1904528	DDF254-1
IVECO	1904529	08.3907.10
IVECO	1904529	93019400
IVECO	1904529	DDF089-1
IVECO	1904531	08.5079.10
IVECO	1904531	93042801
IVECO	1904531	FCR104A
IVECO	1904532	09.3111.20
IVECO	1904532	93084600
IVECO	1904693	09.6957.20
IVECO	1904693	93084500
IVECO	1904693	FCR133A
IVECO	1904696	09.6957.20
IVECO	1904696	93084500
IVECO	1904696	FCR133A
IVECO	1906038	2903701
IVECO	1906038	507.4146.49
IVECO	1906038	FVR713
IVECO	1906039	2904101
IVECO	1906039	507.4146.48
IVECO	1906039	FVR655
IVECO	1906040	2904001
IVECO	1906040	507.4146.57
IVECO	1906041	MF0503
IVECO	1906043	2906705
IVECO	1906043	507.5664.31
IVECO	1906043	FCV733
IVECO	1906070	2903701

MARQUE/MAKER	REF/PN OES	REF/PN
IVECO	1906070	FVR713
IVECO	1906118	2968801
IVECO	1906144	2906504
IVECO	1906144	FCV879
IVECO	1906146	2906705
IVECO	1906146	507.5664.31
IVECO	1906146	FCV733
IVECO	1906153	2035907
IVECO	1906153	FVR839
IVECO	1906155	2118801
IVECO	1906155	507.4146.61
IVECO	1906155	FVR511
IVECO	1906158	2903701
IVECO	1906158	507.4146.49
IVECO	1906158	FVR713
IVECO	1906159	2904101
IVECO	1906159	507.4146.48
IVECO	1906159	FVR655
IVECO	1906183	2900102
IVECO	1906206	2118801
IVECO	1906206	507.4146.51
IVECO	1906206	FVR511
IVECO	1906216	2901602
IVECO	1906243	507.4146.58
IVECO	1906264	2900102
IVECO	1906297	2906705
IVECO	1906297	507.5664.31
IVECO	1906297	FCV733
IVECO	1906298	2906504
IVECO	1906298	FCV879
IVECO	1906345	2901704
IVECO	1906345	FCV503
IVECO	1906353	2906800
IVECO	1906377	MF0525
IVECO	1906401	2912112
IVECO	1906401	507.5944.11
IVECO	1906401	FVR1102
IVECO	1906402	2906705
IVECO	1906402	FCV733
IVECO	1906403	91059000
IVECO	1906403	MP0558
IVECO	1906416	2912204
IVECO	1906416	507.5901.21
IVECO	1906416	FCV1126
IVECO	1906427	2910701
IVECO	1906427	FVR1350
IVECO	1906428	507.4146.86
IVECO	1906429	2914001
IVECO	1906429	507.4146.85
IVECO	1906429	FVR1353
IVECO	1906430	2913801
IVECO	1906430	507.4146.87
IVECO	1906430	FVR1351
IVECO	1906999	2906504
IVECO	1906999	FCV879

Les correspondances de références ont pour seul but la recherche de références;

The cross references are intended only to seek references;

CORRESPONDANCE DES REFERENCES CROSS LIST

MARQUE/MAKER	REF/PN OES	REF/PN
IVECO	1907524	09.6813.20
IVECO	1907524	93084800
IVECO	1907524	FCR105A
IVECO	1907526	09.6763.20
IVECO	1907526	93084900
IVECO	1907526	FCR106A
IVECO	1907527	09.6763.20
IVECO	1907527	93084900
IVECO	1907527	FCR106A
IVECO	1907528	09.6813.20
IVECO	1907528	93084800
IVECO	1907528	FCR105A
IVECO	1907529	09.6813.20
IVECO	1907529	93084800
IVECO	1907529	FCR105A
IVECO	1907530	09.6763.20
IVECO	1907530	93084900
IVECO	1907530	FCR106A
IVECO	1907725	09.6813.20
IVECO	1907725	93084800
IVECO	1907725	FCR105A
IVECO	1907726	09.6763.20
IVECO	1907726	93084900
IVECO	1907726	FCR106A
IVECO	1907765	93084700
IVECO	1907765	DF713577
IVECO	1907942	98022300
IVECO	1908407	507.4656.94
IVECO	1908407	98024800
IVECO	1908577	09.6813.20
IVECO	1908577	93084800
IVECO	1908577	FCR105A
IVECO	1908578	09.6763.20
IVECO	1908578	93084900
IVECO	1908578	FCR106A
IVECO	1908772	08.5959.10
IVECO	1908772	93095100
IVECO	1908772	FCR139A
IVECO	1908773	08.5952.10
IVECO	1908773	93089600
IVECO	1908773	FCR140A
IVECO	1908792	08.5959.10
IVECO	1908792	93095100
IVECO	1908792	FCR139A
IVECO	1908793	08.5952.10
IVECO	1908793	93089600
IVECO	1908793	FCR140A
IVECO	2983279	CR0932
IVECO	2983280	CR0933
IVECO	2983300	CR0928
IVECO	2983301	CR0929
IVECO	2983313	CR0925
IVECO	2983313	CR0936
IVECO	2983314	CR0926
IVECO	2983314	CR0937

MARQUE/MAKER	REF/PN OES	REF/PN
IVECO	2983327	CR0940
IVECO	2983328	CR0941
IVECO	2991646	08.7300.10
IVECO	2991646	93104700
IVECO	2991667	2912303
IVECO	2991667	FVR1405
IVECO	2991667	FVR4140
IVECO	2991743	MC0235
IVECO	2991745	MC0468
IVECO	2991751	MC0292
IVECO	2991753	08.7219.10
IVECO	2991753	93104600
IVECO	2991753	FCR194A
IVECO	2991854	507.9308.63
IVECO	2992339	2912112
IVECO	2992339	507.5944.11
IVECO	2992339	FVR1102
IVECO	2992393	507.4656.05
IVECO	2992393	98042200
IVECO	2992394	507.9308.53
IVECO	2992394	98040900
IVECO	2992568	91059000
IVECO	2992568	MP0558
IVECO	2994066	08.7300.20
IVECO	2994066	93104800
IVECO	2994086	2912111
IVECO	2994086	507.5944.32
IVECO	2994086	FVR1315
IVECO	2995631	2912111
IVECO	2995631	507.5444.32
IVECO	2995631	507.5944.32
IVECO	2995631	FVR1315
IVECO	2995632	2916002
IVECO	2995632	2916004
IVECO	2995632	507.7304.18
IVECO	2995632	FVR1390
IVECO	2995633	2912112
IVECO	2995633	507.5944.11
IVECO	2995633	FVR1102
IVECO	2995693	2912112
IVECO	2995693	507.5944.11
IVECO	2995693	FVR1102
IVECO	2995758	MP0651
IVECO	2995817	MP0651
IVECO	2996009	09.6763.60
IVECO	2996009	FCR341A
IVECO	2996010	09.6813.60
IVECO	2996010	FCR322A
IVECO	2996027	08.9759.20
IVECO	2996027	93177500
IVECO	2996027	FCR316A
IVECO	2996028	08.9759.10
IVECO	2996028	93229100
IVECO	2996028	FCR315A
IVECO	2996033	09.9761.10

Les correspondances de références ont pour seul but la recherche de références;

The cross references are intended only to seek references;

CORRESPONDANCE DES REFERENCES CROSS LIST

MARQUE/MAKER	REF/PN OES	REF/PN
IVECO	2996033	93175300
IVECO	2996033	FCR320A
IVECO	2996043	09.9761.60
IVECO	2996043	92171700
IVECO	2996043	FCR321A
IVECO	2996049	09.9763.10
IVECO	2996049	93177703
IVECO	2996049	FCR332A
IVECO	2996091	2912111
IVECO	2996091	507.5944.32
IVECO	2996091	FVR1315
IVECO	2996121	09.9760.10
IVECO	2996121	92155700
IVECO	2996121	FCR317A
IVECO	2996122	09.9762.10
IVECO	2996122	93177603
IVECO	2996122	FCR329A
IVECO	2996131	09.9758.10
IVECO	2996131	92155900
IVECO	2996131	FCR314A
IVECO	2996418	09.A315.60
IVECO	2996418	93221200
IVECO	2996418	FCR342A
IVECO	2996419	09.A315.10
IVECO	2996419	93221300
IVECO	2996419	FCR338A
IVECO	2996465	2912112
IVECO	2996465	507.5944.11
IVECO	2996465	FVR1102
IVECO	2996498	08.5952.10
IVECO	2996498	93089600
IVECO	2996498	FCR140A
IVECO	2996518	2925601
IVECO	2996518	507.9814.21
IVECO	2996518	FCV4254
IVECO	2996520	2925601
IVECO	2996520	507.9814.11
IVECO	2996520	FCV4254
IVECO	2996535	2912112
IVECO	2996535	507.5944.11
IVECO	2996535	FVR1102
IVECO	2996605	2912111
IVECO	2996605	FVR1315
IVECO	2997355	CR1005
IVECO	2997420	CR1006
IVECO	2997520	CR1007
IVECO	2997702	2912111
IVECO	29996346	98042200
IVECO	4071472	CR1012
IVECO	4122369	CR1010
IVECO	4122669	CR1010
IVECO	4164296	MC0626
IVECO	4178751	COR301
IVECO	4210961	MC0632
IVECO	4212449	CR1014

MARQUE/MAKER	REF/PN OES	REF/PN
IVECO	4220639	CR1016
IVECO	4220643	CR1011
IVECO	4237415	MC0623
IVECO	42470835	2912111
IVECO	42470835	507.5944.32
IVECO	42470835	FVR1315
IVECO	42470836	08.7219.10
IVECO	42470836	93104600
IVECO	42470836	FCR194A
IVECO	42470837	522.7220.01
IVECO	42470838	522.7220.02
IVECO	42470841	2912303
IVECO	42470841	507.7273.12
IVECO	42470841	FVR1405
IVECO	42470841	FVR4140
IVECO	42470842	08.5959.10
IVECO	42470842	93095100
IVECO	42470842	FCR139A
IVECO	424708425	08.5952.10
IVECO	424708425	93089600
IVECO	424708425	FCR140A
IVECO	42470846	2912112
IVECO	42470846	507.5944.11
IVECO	42470846	FVR1102
IVECO	42470847	522.7773.28
IVECO	42470848	522.7773.29
IVECO	42471034	08.7300.20
IVECO	42471034	93104800
IVECO	42471111	08.5952.10
IVECO	42471111	93089600
IVECO	42471111	FCR140A
IVECO	42471150	08.7772.10
IVECO	42471150	93127300
IVECO	42471150	FCR236A
IVECO	42471155	08.7219.10
IVECO	42471155	93104600
IVECO	42471155	FCR194A
IVECO	42471214	09.7723.10
IVECO	42471214	93127200
IVECO	42471214	FCR235A
IVECO	42530362	522.7775.28
IVECO	42530363	522.7775.29
IVECO	42530542	MC0235
IVECO	42532300	522.5660.08
IVECO	42532301	522.5660.09
IVECO	42532302	522.5670.08
IVECO	42532303	522.5670.09
IVECO	42532304	522.5760.08
IVECO	42532305	522.5760.09
IVECO	42532306	522.5770.16
IVECO	42532307	522.5770.26
IVECO	42532362	520.4910.82
IVECO	42532363	520.4910.83
IVECO	42532364	520.4910.84
IVECO	42532365	520.4910.85

Les correspondances de références ont pour seul but la recherche de références;

The cross references are intended only to seek references;

CORRESPONDANCE DES REFERENCES CROSS LIST

MARQUE/MAKER	REF/PN OES	REF/PN
IVECO	42532690	522.5770.16
IVECO	42532691	522.5770.26
IVECO	42533000	522.5760.08
IVECO	42533001	522.5760.09
IVECO	42533002	522.5770.16
IVECO	42533004	522.5770.26
IVECO	42533005	522.5660.08
IVECO	42533006	522.5660.09
IVECO	42533007	522.5670.08
IVECO	42533008	522.5670.09
IVECO	42534115	522.5660.08
IVECO	42534115	EFR166
IVECO	42534116	522.5660.09
IVECO	42534116	EFR167
IVECO	42534117	522.5670.08
IVECO	42534118	522.5670.09
IVECO	42534119	522.5760.08
IVECO	42534120	522.5760.09
IVECO	42534121	522.5770.16
IVECO	42534122	522.5770.26
IVECO	42535110	522.7270.52
IVECO	42535111	522.7270.62
IVECO	42535438	522.7306.28
IVECO	42535439	522.7306.29
IVECO	42535599	522.7301.28
IVECO	42535600	522.7301.29
IVECO	42535775	507.7186.10
IVECO	42535791	2912112
IVECO	42535791	507.5944.11
IVECO	42535791	507.5944.19
IVECO	42535791	FVR1102
IVECO	42535858	MP0650SA
IVECO	42536101	2916002
IVECO	42536101	2916004
IVECO	42536101	507.7304.18
IVECO	42536101	FVR1390
IVECO	42536172	522.7773.28
IVECO	42536173	522.7773.29
IVECO	42536174	522.7775.28
IVECO	42536175	522.7775.29
IVECO	42536259	527.5972.50
IVECO	42536301	507.7186.30
IVECO	42536624	522.7773.28
IVECO	42536625	522.7773.29
IVECO	42536626	522.7775.28
IVECO	42536627	522.7775.29
IVECO	42536628	522.7220.01
IVECO	42536629	522.7220.02
IVECO	42536630	522.7270.52
IVECO	42536631	522.7270.62
IVECO	42536632	522.7301.28
IVECO	42536633	522.7301.29
IVECO	42536634	522.7306.28
IVECO	42536635	522.7306.29
IVECO	42546401	08.9459.20

MARQUE/MAKER	REF/PN OES	REF/PN
IVECO	42546401	93175400
IVECO	42546401	FCR313A
IVECO	4254725	CR1023
IVECO	42548179	522.9272.01
IVECO	42548180	522.9272.02
IVECO	42548181	522.7270.52
IVECO	42548182	522.7270.62
IVECO	42548183	522.7301.28
IVECO	42548184	522.7301.29
IVECO	42548185	522.7306.28
IVECO	42548186	522.7306.29
IVECO	42548187	522.7773.28
IVECO	42548188	522.7773.29
IVECO	42548189	522.7775.28
IVECO	42548190	522.7775.29
IVECO	42548191	2912111
IVECO	42548191	FVR1315
IVECO	42548192	2916002
IVECO	42548192	2916004
IVECO	42548192	FVR1390
IVECO	42548194	2912112
IVECO	42548194	507.5944.11
IVECO	42548194	FVR1102
IVECO	42548195	507.4656.05
IVECO	42548195	98042200
IVECO	42548196	507.9308.53
IVECO	42548196	98040900
IVECO	42548197	522.5000.27
IVECO	42548208	507.4656.94
IVECO	42548208	98024800
IVECO	42548209	507.9308.63
IVECO	42554758	522.9721.00
IVECO	42554759	522.9721.01
IVECO	42554777	522.7270.52
IVECO	42554778	522.7270.62
IVECO	42554990	522.9782.10
IVECO	42554991	522.9782.20
IVECO	42555406	2912303
IVECO	42555406	507.7273.16
IVECO	42555406	FVR1405
IVECO	42555406	FVR4140
IVECO	42555416	522.5000.27
IVECO	42555557	522.9700.10
IVECO	42555558	522.9700.20
IVECO	42555559	522.9788.10
IVECO	42555560	522.9788.20
IVECO	42555633	2923101
IVECO	42555633	507.9786.10
IVECO	42555633	FVR4039
IVECO	42555634	507.9308.63
IVECO	42555634	98040700
IVECO	42555669	2912204
IVECO	42555669	507.5901.30
IVECO	42555669	FCV1126
IVECO	42555881	2922901

Les correspondances de références ont pour seul but la recherche de références;

The cross references are intended only to seek references;



CORRESPONDANCE DES REFERENCES CROSS LIST

MARQUE/MAKER	REF/PN OES	REF/PN
IVECO	4255881	507.9703.10
IVECO	4255881	FVR4036
IVECO	4255917	2923201
IVECO	4255917	507.9724.10
IVECO	4255917	FVR4037
IVECO	42556205	507.9308.66
IVECO	42556205	98040800
IVECO	42556773	527.5972.50
IVECO	42556774	MP0650SA
IVECO	42556837	MC0634
IVECO	42556838	MC0636
IVECO	42559189	522.9800.08
IVECO	42559190	522.9800.09
IVECO	42559191	507.9308.62
IVECO	42559199	522.9802.08
IVECO	42559200	522.9802.09
IVECO	42559201	522.9801.08
IVECO	42559202	522.9801.09
IVECO	42559203	522.9803.08
IVECO	42559204	522.9803.09
IVECO	42559248	2925601
IVECO	42559248	507.9814.21
IVECO	42559248	FCV4254
IVECO	42559249	2925601
IVECO	42559249	507.9814.11
IVECO	42559249	FCV4254
IVECO	42559616	507.9308.53
IVECO	42559616	98040900
IVECO	42559617	522.7270.52
IVECO	42559618	522.7270.62
IVECO	42560068	507.9308.63
IVECO	42560068	98040700
IVECO	42560072	522.9700.10
IVECO	42560073	522.9700.20
IVECO	42560080	2912303
IVECO	42560080	507.7273.97
IVECO	42560080	FVR1405
IVECO	42560080	FVR4140
IVECO	42560913	507.9308.62
IVECO	42561101	2912303
IVECO	42561101	507.7273.12
IVECO	42561101	FVR1405
IVECO	42561101	FVR4140
IVECO	42561102	2912303
IVECO	42561102	507.7273.12
IVECO	42561102	FVR1405
IVECO	42561102	FVR4140
IVECO	42561355	2922901
IVECO	42561355	507.9703.10
IVECO	42561355	FVR4036
IVECO	42561695	520.4910.82
IVECO	42561696	520.4910.83
IVECO	42561697	520.4910.84
IVECO	42561698	520.4910.85
IVECO	42561703	520.5150.11

MARQUE/MAKER	REF/PN OES	REF/PN
IVECO	42561704	520.5150.21
IVECO	42562769	COR303
IVECO	42567354	507.9308.66
IVECO	42567354	98040800
IVECO	42567355	98040900
IVECO	42567447	2912303
IVECO	42567447	FVR1405
IVECO	42567447	FVR4140
IVECO	42567660	98024800
IVECO	42568306	MC0635
IVECO	42568969	522.5760.08
IVECO	42568970	522.5760.09
IVECO	42568971	522.5770.16
IVECO	42568972	522.5770.26
IVECO	42576680	2912303
IVECO	42576975	2922901
IVECO	42576975	FVR4036
IVECO	4269534	MC0633
IVECO	4272449	CR1014
IVECO	4276036	CR1015
IVECO	4277473	COR301
IVECO	4277619	MC0632
IVECO	4291534	CR0620
IVECO	4294681	CR1018
IVECO	4296247	CR1017
IVECO	4324597	MC0626
IVECO	4457816	MC0630
IVECO	4712856	CR1019
IVECO	4717095	COR301
IVECO	4723798	MC0623
IVECO	4727624	CR1007
IVECO	4732110	MC0626
IVECO	4744164	CR1007
IVECO	4754206	MC0626
IVECO	4758288	MC0627
IVECO	4762814	MC0626
IVECO	4765078	MC0623
IVECO	4783798	MC0623
IVECO	4792418	COR305
IVECO	4797280	MC0110
IVECO	4797460	MC0110
IVECO	4797843	MC0625
IVECO	4797844	MC0629
IVECO	4802930	MC0110
IVECO	4804129	MC0100
IVECO	4804131	MC0624
IVECO	4804132	MC0628
IVECO	4817854	MC0101
IVECO	4830626	EFR162
IVECO	4830627	EFR163
IVECO	4832624	522.5670.08
IVECO	4832624	EFR158
IVECO	4832625	522.5670.09
IVECO	4832625	EFR159
IVECO	4832627	EFR134

Les correspondances de références ont pour seul but la recherche de références;

The cross references are intended only to seek references;

CORRESPONDANCE DES REFERENCES CROSS LIST

MARQUE/MAKER	REF/PN OES	REF/PN
IVECO	4832628	EFR135
IVECO	4837192	CR0620
IVECO	4844300	MC0110
IVECO	4844301	MC0110
IVECO	4846034	FL3207
IVECO	4846035	FL3208
IVECO	4855363	520.4910.83
IVECO	4855364	520.4910.84
IVECO	4855365	520.4910.85
IVECO	4855708	EFR043
IVECO	4855709	EFR044
IVECO	4977844	MC0629
IVECO	500028834	2466301
IVECO	500028835	2074105
IVECO	500029493	2074105
IVECO	500054528	98024800
IVECO	500054695	507.9308.66
IVECO	500054695	98040800
IVECO	500054697	507.9308.63
IVECO	500054697	98040700
IVECO	500055564	507.9308.66
IVECO	500055565	2912112
IVECO	500055565	FVR1102
IVECO	5001106	2901602
IVECO	500300073	FL3001
IVECO	500300075	FL3002
IVECO	500300079	FL3003
IVECO	500300080	FL3004
IVECO	500302157	520.4910.82
IVECO	500302158	520.4910.83
IVECO	500305138	522.7220.01
IVECO	500305139	522.7220.02
IVECO	500306590	08.7219.10
IVECO	500306590	93104600
IVECO	500306590	FCR194A
IVECO	500319571	COR302
IVECO	500322079	09.7723.10
IVECO	500322079	93127200
IVECO	500322079	FCR235A
IVECO	500322988	CFM008
IVECO	500325952	COR302
IVECO	500325952	COR304
IVECO	500329931	COR300
IVECO	500330885	522.7220.01
IVECO	500330886	522.7220.02
IVECO	500349932	09.7723.10
IVECO	500349932	93127200
IVECO	500349932	FCR235A
IVECO	500352565	522.5760.08
IVECO	500352566	522.5760.09
IVECO	500352568	522.5770.16
IVECO	500352569	522.5770.26
IVECO	500352571	522.5660.08
IVECO	500352572	522.5660.09
IVECO	500352574	522.5670.08

MARQUE/MAKER	REF/PN OES	REF/PN
IVECO	500352575	522.5670.09
IVECO	500359653	MC0460
IVECO	500362730	CFM009
IVECO	500369260	527.7704.12
IVECO	500369261	527.7704.22
IVECO	500374416	MC0431
IVECO	5004032	2901602
IVECO	503471083	08.5079.10
IVECO	503471083	93042801
IVECO	503471083	FCR104A
IVECO	503643887	91059000
IVECO	503643887	MP0558
IVECO	503643887	MP0651
IVECO	504003617	CFM009
IVECO	504028767	522.7220.01
IVECO	504028768	522.7220.02
IVECO	504028769	522.7220.01
IVECO	504028770	522.7220.02
IVECO	504042984	MC0431
IVECO	504042985	MC0460
IVECO	504060926	527.5960.77
IVECO	504060927	527.5960.87
IVECO	504074524	522.7773.28
IVECO	504074524	522.7773.29
IVECO	504074543	522.7775.28
IVECO	504074544	522.7775.29
IVECO	504079365	08.9459.20
IVECO	504079365	93175400
IVECO	504079365	FCR313A
IVECO	504080994	08.9459.20
IVECO	504080994	93175400
IVECO	504080994	FCR313A
IVECO	504085822	522.9272.01
IVECO	504085823	522.9272.02
IVECO	504089710	MC0431
IVECO	504089711	MC0460
IVECO	504090405	522.7220.01
IVECO	504090406	522.7220.02
IVECO	504093276	527.7704.12
IVECO	504093277	527.7704.22
IVECO	504093779	2916002
IVECO	504093779	2916004
IVECO	504093779	FVR1390
IVECO	504093780	2912112
IVECO	504093780	507.5944.11
IVECO	504093780	FVR1102
IVECO	504102692	527.5960.77
IVECO	504102693	527.5960.87
IVECO	504113573	522.7270.52
IVECO	504113574	522.7270.62
IVECO	504120470	522.9700.10
IVECO	504120471	522.9700.20
IVECO	504120969	522.9721.00
IVECO	504120970	522.9721.01
IVECO	504121605	09.9758.10

Les correspondances de références ont pour seul but la recherche de références;

The cross references are intended only to seek references;

CORRESPONDANCE DES REFERENCES CROSS LIST

MARQUE/MAKER	REF/PN OES	REF/PN
IVECO	504121605	92155900
IVECO	504121605	FCR314A
IVECO	504121612	09.9760.10
IVECO	504121612	92155700
IVECO	504121612	FCR317A
IVECO	504121723	09.9762.10
IVECO	504121723	93177603
IVECO	504121723	FCR329A
IVECO	504121785	522.9788.10
IVECO	504121786	522.9788.20
IVECO	504122833	522.9782.10
IVECO	504122834	522.9782.20
IVECO	504129079	MP0651
IVECO	504129712	527.7704.12
IVECO	504129713	527.7704.22
IVECO	504134582	522.7270.52
IVECO	504134583	522.7270.62
IVECO	504139833	522.9700.10
IVECO	504139834	522.9700.20
IVECO	504201378	CFM011
IVECO	504201383	CFM010
IVECO	504216700	520.9576.10
IVECO	504216701	520.9576.20
IVECO	504234182	522.9800.08
IVECO	504234183	522.9800.09
IVECO	504234186	522.9802.08
IVECO	504234187	522.9802.09
IVECO	504234189	522.9801.08
IVECO	504234190	522.9801.09
IVECO	504234209	522.9803.08
IVECO	504234210	522.9803.09
IVECO	504267884	08.A260.10
IVECO	504267884	FCR343A
IVECO	504347501	CFM010
IVECO	504347502	CFM011
IVECO	504354331	522.9700.10
IVECO	504354332	522.9700.20
IVECO	504354333	522.9700.10
IVECO	504354334	522.9700.20
IVECO	504360794	522.7270.52
IVECO	504360795	522.7270.62
IVECO	5801268962	2922901
IVECO	5801268962	FVR4036
IVECO	5801268964	2922901
IVECO	5801268964	FVR4036
IVECO	5801324147	527.7704.19
IVECO	5801324148	527.7704.29
IVECO	5801639518	09.9758.10
IVECO	5801639518	92155900
IVECO	5801639518	FCR314A
IVECO	5801910700	MC0100
IVECO	5938118	08.3907.10
IVECO	5938118	93019400
IVECO	5938118	DDF089-1
IVECO	60102882	CR0620

MARQUE/MAKER	REF/PN OES	REF/PN
IVECO	60188878	MC0292
IVECO	60806223	COR302
IVECO	69021740	CR1021
IVECO	69022780	CR1021
IVECO	69030110	CR1021
IVECO	7162112	TF0014
IVECO	7165213	CR1011
IVECO	7165379	TF0014
IVECO	7165402	TF790065
IVECO	7165802	CR1023
IVECO	7166041	TF790078
IVECO	7168368	09.3111.20
IVECO	7168368	93084600
IVECO	7169714	CFM005
IVECO	7171255	93084700
IVECO	7171255	DF713577
IVECO	7171274	09.3111.20
IVECO	7172018	09.6763.20
IVECO	7172018	93084900
IVECO	7172018	FCR106A
IVECO	7172078	09.6763.20
IVECO	7172078	93084900
IVECO	7172078	FCR106A
IVECO	7173036	09.6813.20
IVECO	7173036	93084800
IVECO	7173036	FCR105A
IVECO	7180039	KA0002
IVECO	7180256	08.5952.10
IVECO	7180256	93089600
IVECO	7180256	FCR140A
IVECO	7182299	08.7300.10
IVECO	7182299	93104700
IVECO	7182300	08.7300.20
IVECO	7182300	93104800
IVECO	7182681	09.6813.20
IVECO	7182681	93084800
IVECO	7182681	FCR105A
IVECO	7182682	09.6763.20
IVECO	7182682	93084900
IVECO	7182682	FCR106A
IVECO	7182874	08.7772.10
IVECO	7182874	93127300
IVECO	7182874	FCR236A
IVECO	7185410	08.7300.20
IVECO	7185410	93104800
IVECO	7186309	08.9759.20
IVECO	7186309	93177500
IVECO	7186309	FCR316A
IVECO	7186485	09.9761.60
IVECO	7186485	92171700
IVECO	7186485	FCR321A
IVECO	7186848	09.9763.10
IVECO	7186848	93177703
IVECO	7186848	FCR332A
IVECO	7187567	09.6813.60

Les correspondances de références ont pour seul but la recherche de références;

The cross references are intended only to seek references;

CORRESPONDANCE DES REFERENCES CROSS LIST

MARQUE/MAKER	REF/PN OES	REF/PN
IVECO	7187567	FCR322A
IVECO	7187569	09.6763.60
IVECO	7187569	FCR341A
IVECO	7188080	08.9759.10
IVECO	7188080	93229100
IVECO	7188080	FCR315A
IVECO	7188210	09.9761.10
IVECO	7188210	93175300
IVECO	7188210	FCR320A
IVECO	7189265	09.A315.10
IVECO	7189265	93221300
IVECO	7189265	FCR338A
IVECO	7189456	09.A315.60
IVECO	7189456	93221200
IVECO	7189456	FCR342A
IVECO	7571999	COR302
IVECO	7699530	COR300
IVECO	7910200	TF0014
IVECO	793149	COR302
IVECO	7980525	CR1002
IVECO	7984212	CR1020
IVECO	7984278	CR0414
IVECO	8121103	CR1020
IVECO	8121104	CR0414
IVECO	8121575	CR1002
IVECO	8121576	CR1003
IVECO	8122258	MC0161
IVECO	8123580	CR0420
IVECO	8193387	CR1020
IVECO	8193797	CR0928
IVECO	8193798	CR0929
IVECO	8193799	CR0932
IVECO	8193800	CR0933
IVECO	8193801	CR0940
IVECO	8193802	CR0941
IVECO	8193803	CR0925
IVECO	8193803	CR0936
IVECO	8193804	CR0926
IVECO	8193804	CR0937
IVECO	8194527	CR0420
IVECO	8582290	08.5374.10
IVECO	8582290	93084400
IVECO	8582290	DDF254-1
IVECO	8584182	08.5079.10
IVECO	8584182	93042801
IVECO	8584182	FCR104A
IVECO	9290536	MC0632
IVECO	93155720	CR0420
IVECO	93155721	CR1020
IVECO	93155722	CR0414
IVECO	93156969	520.4910.82
IVECO	93156970	520.4910.83
IVECO	93156971	520.4910.84
IVECO	93156972	520.4910.85
IVECO	93159002	CR1005

MARQUE/MAKER	REF/PN OES	REF/PN
IVECO	93160540	CR1005
IVECO	93161314	507.4146.59
IVECO	93161850	527.5972.50
IVECO	93192367	520.4910.83
IVECO	93192368	520.4910.82
IVECO	93192369	520.4910.84
IVECO	93192370	520.4910.85
IVECO	93800492	08.3907.10
IVECO	93800492	93019400
IVECO	93800492	DDF089-1
IVECO	93802698	EFR131
IVECO	93802699	EFR130
IVECO	93807230	520.4910.83
IVECO	93807231	520.4910.82
IVECO	93808045	520.4910.83
IVECO	93808046	520.4910.82
IVECO	93808049	EFR132
IVECO	93808050	EFR133
IVECO	93814391	09.6957.20
IVECO	93814391	93084500
IVECO	93814391	FCR133A
IVECO	93814402	09.6957.20
IVECO	93814402	93084500
IVECO	93814402	FCR133A
IVECO	93821867	08.5959.10
IVECO	93821867	93095100
IVECO	93821867	FCR139A
IVECO	93821918	08.5959.10
IVECO	93821918	93095100
IVECO	93821918	FCR139A
IVECO	93831918	08.9459.20
IVECO	93831918	93175400
IVECO	93831918	FCR313A
IVECO	953422	MC0626
IVECO	98407735	EFR043
IVECO	98407736	EFR044
IVECO	98410367	520.5150.11
IVECO	98410369	520.5150.21
IVECO	98414402	09.6957.20
IVECO	98414402	93084500
IVECO	98414402	FCR133A
IVECO	98420511	COR303
IVECO	98434065	MC0292
IVECO	98449332	FL3207
IVECO	98449334	FL3208
IVECO	98452377	FL3209
IVECO	98452378	FL3210
IVECO	98452387	CR1006
IVECO	98457219	FL3001
IVECO	98457220	FL3002
IVECO	98468681	522.5660.08
IVECO	98468683	522.5660.09
IVECO	98469208	522.5670.08
IVECO	98469209	522.5670.09
IVECO	98493240	522.5760.08

Les correspondances de références ont pour seul but la recherche de références;

The cross references are intended only to seek references;

CORRESPONDANCE DES REFERENCES CROSS LIST

MARQUE/MAKER	REF/PN OES	REF/PN
IVECO	98493241	522.5760.09
IVECO	98493243	522.5770.16
IVECO	98493244	522.5770.26
IVECO	99431432	527.5960.77
IVECO	99431433	527.5960.87
IVECO	99434589	CFM006
IVECO	99436561	MC0110
IVECO	99436612	FL3207
IVECO	99436613	FL3208
IVECO	99443476	CFM007
IVECO	99459380	MC0431
IVECO	99463713	MC0292
IVECO	99464094	520.4910.82
IVECO	99464095	520.4910.83
IVECO	99464097	520.4910.84
IVECO	99464098	520.4910.85
IVECO	99464100	520.5150.11
IVECO	99464101	520.5150.21
IVECO	99465302	EFR043
IVECO	99465304	EFR044
IVECO	99465472	520.9576.10
IVECO	99465472	EFR045
IVECO	99465473	520.9576.20
IVECO	99465473	EFR046
IVECO	99465631	520.9576.10
IVECO	99465632	520.9576.20
IVECO	9947364	91059000
IVECO	9947364	MP0558
IVECO	994838200	MC0431
IVECO	99483920	MC0431
IVECO	9980722	TF790147
IVECO	9981629	MC0161
IVECO	9983470	CR1002
IVECO	9983871	CR1003
IVECO	9989017	MC0092
LAND ROVER	GBP90272	2090401
LAND ROVER	GBP90272	FVR836
LAND ROVER	STC2950	2090401
LAND ROVER	STC2950	FVR836
LDV	GBP627	2035908
LDV	GBP627	FVR829
LDV	RTC3348	2090401
LDV	RTC3348	FVR836
MAN	90810818115	MC0630
MERCEDES	0004200079	EFR025
MERCEDES	0004200179	EFR026
MERCEDES	0004202420	2302101
MERCEDES	0004207520	2958104
MERCEDES	0004207520	FDB143
MERCEDES	0004208901	EFR053
MERCEDES	0004209001	EFR054
MERCEDES	0004209101	EFR053
MERCEDES	0004209201	EFR054
MERCEDES	0004209220	2932403
MERCEDES	0004209220	2976402

MARQUE/MAKER	REF/PN OES	REF/PN
MERCEDES	0004209220	FCV958
MERCEDES	0004209301	EFR053
MERCEDES	0004209401	EFR054
MERCEDES	0004209720	2302101
MERCEDES	0004212410	2473901
MERCEDES	0004212410	FVR1039
MERCEDES	0004214110	2302201
MERCEDES	0004216110	2400701
MERCEDES	0004216210	2400801
MERCEDES	0004237110	2915301
MERCEDES	0004237110	FVR1879
MERCEDES	0004314701	MC0093
MERCEDES	0004314701	MC0308
MERCEDES	0004315601	MC0093
MERCEDES	0004315601	MC0308
MERCEDES	0004315701	MC0093
MERCEDES	0004315701	MC0308
MERCEDES	0004316301	MC0473
MERCEDES	0004316401	MC0093
MERCEDES	0004316401	MC0308
MERCEDES	0004316501	MC0093
MERCEDES	0004316501	MC0308
MERCEDES	0004317001	MC0616
MERCEDES	0004317101	MC0617
MERCEDES	0005400217	98021302
MERCEDES	0005868942	2078401
MERCEDES	0005868942	FVR239
MERCEDES	0014200920	2958104
MERCEDES	0014200920	FDB143
MERCEDES	0014201420	2078401
MERCEDES	0014201420	FVR239
MERCEDES	0014201520	2983506
MERCEDES	0014201520	FVR1522B
MERCEDES	0014203401	EFR031
MERCEDES	0014203501	EFR032
MERCEDES	0014206983	EFR095
MERCEDES	0014207083	EFR096
MERCEDES	0014208683	EFR051
MERCEDES	0014208783	EFR052
MERCEDES	0014208820	2976402
MERCEDES	0014208820	FCV958
MERCEDES	0014209020	2932403
MERCEDES	0014209020	2976402
MERCEDES	0014209020	FCV958
MERCEDES	0014209120	2976502
MERCEDES	0014209120	FCV959
MERCEDES	0014209220	2958104
MERCEDES	0014209220	FDB143
MERCEDES	0014210910	2400701
MERCEDES	0014211010	2400801
MERCEDES	0014219898	EFR110
MERCEDES	0014219998	EFR111
MERCEDES	0015866042	2932403
MERCEDES	0015866042	2976402
MERCEDES	0015866042	FCV958

Les correspondances de références ont pour seul but la recherche de références;

The cross references are intended only to seek references;

CORRESPONDANCE DES REFERENCES CROSS LIST

MARQUE/MAKER	REF/PN OES	REF/PN
MERCEDES	0015866342	2958104
MERCEDES	0015866342	FDB143
MERCEDES	0015867042	2078401
MERCEDES	0015867042	FVR239
MERCEDES	0015868942	2078401
MERCEDES	0015868942	FVR239
MERCEDES	0024201083	EFR170
MERCEDES	0024201183	EFR171
MERCEDES	0024201320	2976402
MERCEDES	0024201320	FCV958
MERCEDES	0024201420	2976502
MERCEDES	0024201420	FCV959
MERCEDES	0024201720	2958105
MERCEDES	0024202420	2958105
MERCEDES	0024202920	2976402
MERCEDES	0024202920	FCV958
MERCEDES	0024202983	EFR174
MERCEDES	0024203083	EFR175
MERCEDES	0024203483	EFR126
MERCEDES	0024203583	EFR127
MERCEDES	0024203820	2473901
MERCEDES	0024203820	FVR1039
MERCEDES	0024203920	2399002
MERCEDES	0024203920	FVR1038
MERCEDES	0024204020	2390101
MERCEDES	0024204020	FVR1876
MERCEDES	0024204098	EFR053
MERCEDES	0024204120	2915301
MERCEDES	0024204120	FVR1879
MERCEDES	0024204198	EFR054
MERCEDES	0024204220	2915301
MERCEDES	0024204220	FVR1879
MERCEDES	0024205620	2473901
MERCEDES	0024205620	FVR1039
MERCEDES	0024205720	2983506
MERCEDES	0024205720	FVR1522B
MERCEDES	0024205783	EFR095
MERCEDES	0024205820	91055100
MERCEDES	0024205820	MP0574
MERCEDES	0024205883	EFR096
MERCEDES	0024205920	91057900
MERCEDES	0024205920	MP0594
MERCEDES	0024206020	2390101
MERCEDES	0024206020	FVR1876
MERCEDES	0024206220	2983506
MERCEDES	0024206220	FVR1522B
MERCEDES	0024206920	2473901
MERCEDES	0024206920	FVR1039
MERCEDES	0024209920	2399002
MERCEDES	0024209920	FVR1038
MERCEDES	0024210098	EFR114
MERCEDES	0024210198	EFR115
MERCEDES	0024213898	EFR055
MERCEDES	0024213998	EFR056
MERCEDES	0024214098	EFR053

MARQUE/MAKER	REF/PN OES	REF/PN
MERCEDES	0024214198	EFR054
MERCEDES	0024231198	EFR107
MERCEDES	0024231298	EFR086
MERCEDES	0024231298	EFR106
MERCEDES	0024301401	MC0630
MERCEDES	0024302201	MC0630
MERCEDES	0024302601	MC0630
MERCEDES	0024304101	MC0630
MERCEDES	0024308001	MC0630
MERCEDES	0024308501	MC0630
MERCEDES	0024309201	MC0630
MERCEDES	0034200120	2302201
MERCEDES	0034200720	2078401
MERCEDES	0034200720	FVR239
MERCEDES	0034201420	91055100
MERCEDES	0034201420	MP0574
MERCEDES	0034201520	2983506
MERCEDES	0034201520	FVR1522B
MERCEDES	0034201720	2915301
MERCEDES	0034201720	FVR1879
MERCEDES	0034202083	EFR093
MERCEDES	0034203383	EFR094
MERCEDES	0034203420	91055100
MERCEDES	0034203420	MP0574
MERCEDES	0034203483	EFR085
MERCEDES	0034203620	2958104
MERCEDES	0034203620	FDB143
MERCEDES	0034203720	2958105
MERCEDES	0034203820	2958105
MERCEDES	0034204420	2983506
MERCEDES	0034204420	FVR1522B
MERCEDES	0034204620	2923701
MERCEDES	0034204620	FVR1791
MERCEDES	0034206420	2473901
MERCEDES	0034206420	FVR1039
MERCEDES	0034207183	EFR073
MERCEDES	0034207283	EFR074
MERCEDES	0034207383	EFR075
MERCEDES	0034207420	2958104
MERCEDES	0034207420	2976502
MERCEDES	0034207420	FCV959
MERCEDES	0034207420	FDB143
MERCEDES	0034207483	EFR076
MERCEDES	0034207520	2958105
MERCEDES	0034207620	2958105
MERCEDES	0034207720	2983506
MERCEDES	0034207720	FVR1522B
MERCEDES	0034207820	2400701
MERCEDES	0034207910	2400701
MERCEDES	0034208583	EFR065
MERCEDES	0034208683	EFR066
MERCEDES	0034208783	EFR077
MERCEDES	0034208883	EFR078
MERCEDES	0034213998	EFR053
MERCEDES	0034214098	EFR054

Les correspondances de références ont pour seul but la recherche de références;

The cross references are intended only to seek references;

CORRESPONDANCE DES REFERENCES CROSS LIST

MARQUE/MAKER	REF/PN OES	REF/PN
MERCEDES	0034214198	EFR055
MERCEDES	0034214298	EFR056
MERCEDES	0034214398	EFR055
MERCEDES	0034214498	EFR056
MERCEDES	0034214598	EFR053
MERCEDES	0034214698	EFR054
MERCEDES	0034214798	EFR053
MERCEDES	0034214898	EFR054
MERCEDES	0034214998	EFR055
MERCEDES	0034215098	EFR056
MERCEDES	0034302801	MC0620
MERCEDES	0034304101	MC0630
MERCEDES	0034304601	MC0630
MERCEDES	0034307901	MC0618
MERCEDES	0034308201	MC0618
MERCEDES	0035401217	98016800
MERCEDES	0044201420	2078401
MERCEDES	0044201420	FVR239
MERCEDES	0044201520	2915301
MERCEDES	0044201520	FVR1879
MERCEDES	0044202420	2915301
MERCEDES	0044202420	FVR1879
MERCEDES	0044202520	2302101
MERCEDES	0044202620	2915301
MERCEDES	0044202620	FVR1879
MERCEDES	0044202720	2390101
MERCEDES	0044202720	FVR1876
MERCEDES	0044204183	EFR112
MERCEDES	0044204283	EFR113
MERCEDES	0044204383	EFR116
MERCEDES	0044204483	EFR110
MERCEDES	0044204583	EFR114
MERCEDES	0044204820	2983506
MERCEDES	0044204820	FVR1522B
MERCEDES	0044204883	EFR117
MERCEDES	0044204983	EFR111
MERCEDES	0044205083	EFR115
MERCEDES	0044205520	2399002
MERCEDES	0044205520	FVR1038
MERCEDES	0044205583	EFR065
MERCEDES	0044205620	2473901
MERCEDES	0044205620	FVR1039
MERCEDES	0044205683	EFR066
MERCEDES	0044205783	EFR077
MERCEDES	0044205883	EFR078
MERCEDES	0044206720	2919202
MERCEDES	0044206720	FVR1778
MERCEDES	0044206820	2920002
MERCEDES	0044206820	FVR1777
MERCEDES	0044206920	2919001
MERCEDES	0044206920	FVR1780
MERCEDES	0044208120	2921702
MERCEDES	0044208120	FVR1779
MERCEDES	0044208120	FVR4429
MERCEDES	0044208220	2920002

MARQUE/MAKER	REF/PN OES	REF/PN
MERCEDES	0044208220	FVR1777
MERCEDES	0044208320	2919202
MERCEDES	0044208320	FVR1778
MERCEDES	0044217898	EFR053
MERCEDES	0044217998	EFR054
MERCEDES	0044218298	EFR055
MERCEDES	0044218398	EFR056
MERCEDES	0044302801	MC0620
MERCEDES	0044303001	MC0618
MERCEDES	0054202120	2919202
MERCEDES	0054202120	FVR1778
MERCEDES	0054205220	2919202
MERCEDES	0054205220	FVR1778
MERCEDES	0054205320	2920002
MERCEDES	0054205320	FVR1777
MERCEDES	0054207020	2919202
MERCEDES	0054207020	FVR1778
MERCEDES	0054207420	2921702
MERCEDES	0054207420	FVR1779
MERCEDES	0054207420	FVR4429
MERCEDES	0054208118	CR0581
MERCEDES	0054208620	2915301
MERCEDES	0054208620	FVR1879
MERCEDES	0054209820	2078401
MERCEDES	0054209820	FVR239
MERCEDES	0064202220	2921702
MERCEDES	0064202220	FVR1779
MERCEDES	0064202220	FVR4429
MERCEDES	0064204320	2400701
MERCEDES	0064204420	2400801
MERCEDES	0064204520	2921702
MERCEDES	0064204520	FVR1779
MERCEDES	0064204520	FVR4429
MERCEDES	0064208420	2919202
MERCEDES	0064208420	FVR1778
MERCEDES	0064211798	EFR055
MERCEDES	0064211898	EFR056
MERCEDES	0064211998	EFR049
MERCEDES	0064211998	EFR055
MERCEDES	0064212098	EFR050
MERCEDES	0064212098	EFR056
MERCEDES	0064212198	EFR053
MERCEDES	0064212298	EFR054
MERCEDES	0064212398	EFR053
MERCEDES	0064212498	EFR054
MERCEDES	0064212998	EFR055
MERCEDES	0064213098	EFR056
MERCEDES	0064213198	EFR055
MERCEDES	0064213298	EFR056
MERCEDES	0074210498	EFR085
MERCEDES	0074211598	EFR055
MERCEDES	0074211698	EFR056
MERCEDES	0074213198	EFR055
MERCEDES	0074213298	EFR056
MERCEDES	0074218398	EFR053

Les correspondances de références ont pour seul but la recherche de références;

The cross references are intended only to seek references;

CORRESPONDANCE DES REFERENCES CROSS LIST

MARQUE/MAKER	REF/PN OES	REF/PN
MERCEDES	0074218498	EFR054
MERCEDES	0084202418	CR0748
MERCEDES	0084204020	2078401
MERCEDES	0084204020	FVR239
MERCEDES	0084204218	CR0581
MERCEDES	0084204418	CR0748
MERCEDES	0084204620	2915301
MERCEDES	0084204620	FVR1879
MERCEDES	0084204920	2915301
MERCEDES	0084204920	FVR1879
MERCEDES	0084205020	2919202
MERCEDES	0084205020	FVR1778
MERCEDES	0084211898	EFR053
MERCEDES	0084211998	EFR054
MERCEDES	0084212098	EFR053
MERCEDES	0084212198	EFR054
MERCEDES	0094201118	CR0748
MERCEDES	0174202018	CR0420
MERCEDES	0219974947	KB0001
MERCEDES	0219975547	KB0001
MERCEDES	1004200473	08.6923.20
MERCEDES	1004200473	93054600
MERCEDES	1004200473	FCR117A
MERCEDES	1004200873	08.6923.20
MERCEDES	1004200873	93054600
MERCEDES	1004200873	FCR117A
MERCEDES	1265402017	98021302
MERCEDES	4054210098	EFR112
MERCEDES	4054210198	EFR113
MERCEDES	4054210298	EFR116
MERCEDES	4054210398	EFR117
MERCEDES	4054210698	EFR116
MERCEDES	4054210798	EFR117
MERCEDES	4164210098	EFR093
MERCEDES	4164210198	EFR085
MERCEDES	4164210298	EFR107
MERCEDES	4164210398	EFR086
MERCEDES	4164210398	EFR106
MERCEDES	4164210412	08.6750.20
MERCEDES	4164210412	93015500
MERCEDES	4164210412	FCR364A
MERCEDES	4164210598	EFR094
MERCEDES	4164210698	EFR107
MERCEDES	4164210798	EFR086
MERCEDES	4164210798	EFR106
MERCEDES	4174210012	08.6750.10
MERCEDES	4174210012	93066400
MERCEDES	4174210012	FCR156A
MERCEDES	4184210198	EFR116
MERCEDES	4184210298	EFR117
MERCEDES	4184210698	EFR112
MERCEDES	4184210798	EFR113
MERCEDES	4184211598	EFR112
MERCEDES	4184211698	EFR113
MERCEDES	4194210098	EFR093

MARQUE/MAKER	REF/PN OES	REF/PN
MERCEDES	4194210198	EFR085
MERCEDES	4194210298	EFR094
MERCEDES	4194210498	EFR107
MERCEDES	4194210598	EFR086
MERCEDES	4194210598	EFR106
MERCEDES	4194210698	EFR093
MERCEDES	4194210798	EFR094
MERCEDES	4194210898	EFR085
MERCEDES	4194211098	EFR086
MERCEDES	4194211098	EFR106
MERCEDES	4194211198	EFR107
MERCEDES	4194211298	EFR086
MERCEDES	4254210012	93025600
MERCEDES	4274210098	EFR093
MERCEDES	4274210198	EFR085
MERCEDES	4274210298	EFR094
MERCEDES	4274210498	EFR107
MERCEDES	4274210598	EFR086
MERCEDES	4274210598	EFR106
MERCEDES	4274211798	EFR114
MERCEDES	4274211898	EFR115
MERCEDES	4274211998	EFR093
MERCEDES	4274212098	EFR094
MERCEDES	4274212198	EFR085
MERCEDES	4274212398	EFR086
MERCEDES	4274212398	EFR106
MERCEDES	4274212498	EFR107
MERCEDES	4354210498	EFR086
MERCEDES	4354210498	EFR106
MERCEDES	4354210598	EFR107
MERCEDES	4354211498	EFR085
MERCEDES	4355420017	98022100
MERCEDES	4374210198	EFR110
MERCEDES	4374210298	EFR111
MERCEDES	4374210498	EFR114
MERCEDES	4374210598	EFR115
MERCEDES	4374210798	EFR110
MERCEDES	4374210898	EFR111
MERCEDES	4374211098	EFR114
MERCEDES	4374211198	EFR115
MERCEDES	4374211298	EFR110
MERCEDES	4374211398	EFR111
MERCEDES	4374211498	EFR114
MERCEDES	4374211598	EFR115
MERCEDES	4374211698	EFR110
MERCEDES	4374211798	EFR111
MERCEDES	4374211898	EFR114
MERCEDES	4374211998	EFR115
MERCEDES	4374212098	EFR112
MERCEDES	4374212198	EFR113
MERCEDES	4374212298	EFR116
MERCEDES	4374212398	EFR117
MERCEDES	4374212598	EFR116
MERCEDES	4374212698	EFR117
MERCEDES	4404210098	EFR093

Les correspondances de références ont pour seul but la recherche de références;

The cross references are intended only to seek references;

CORRESPONDANCE DES REFERENCES CROSS LIST

MARQUE/MAKER	REF/PN OES	REF/PN
MERCEDES	4404210198	EFR094
MERCEDES	4404210298	EFR085
MERCEDES	4604200020	2078401
MERCEDES	4604200020	FVR239
MERCEDES	5420742028	2921702
MERCEDES	5420742028	FVR1779
MERCEDES	5420742028	FVR4429
MERCEDES	6014200072	08.3959.20
MERCEDES	6014200072	93012400
MERCEDES	6014200072	FCR116A
MERCEDES	6014200172	08.6923.20
MERCEDES	6014200172	93054600
MERCEDES	6014200172	FCR117A
MERCEDES	6014200272	08.3959.20
MERCEDES	6014200272	93012400
MERCEDES	6014200272	FCR116A
MERCEDES	6014200372	08.6923.20
MERCEDES	6014200372	93054600
MERCEDES	6014200372	FCR117A
MERCEDES	6014207620	2078401
MERCEDES	6014207620	FVR239
MERCEDES	6014208720	2078401
MERCEDES	6014208720	FVR239
MERCEDES	6014210208	2078401
MERCEDES	6014210208	FVR239
MERCEDES	6014210312	08.6923.20
MERCEDES	6014210312	93054600
MERCEDES	6014210312	FCR117A
MERCEDES	6014210408	2078401
MERCEDES	6014210408	FVR239
MERCEDES	6014210412	08.3959.20
MERCEDES	6014210412	93012400
MERCEDES	6014210412	FCR116A
MERCEDES	6014210512	08.6923.20
MERCEDES	6014210512	93054600
MERCEDES	6014210512	FCR117A
MERCEDES	6014210608	2078401
MERCEDES	6014210608	FVR239
MERCEDES	6014215012	08.3959.20
MERCEDES	6014215012	93012400
MERCEDES	6014215012	FCR116A
MERCEDES	6014215112	08.3959.20
MERCEDES	6014215112	93012400
MERCEDES	6014215112	FCR116A
MERCEDES	6014217720	2157302
MERCEDES	6014217720	FVR941
MERCEDES	6014235001	TF0221
MERCEDES	6014235101	TF0220
MERCEDES	6014300922	MF0572
MERCEDES	6015400617	98016800
MERCEDES	6015401317	98021302
MERCEDES	6015860042	2078401
MERCEDES	6015860042	FVR239
MERCEDES	6114209020	MF0525
MERCEDES	6314200020	2157302

MARQUE/MAKER	REF/PN OES	REF/PN
MERCEDES	6314200020	FVR941
MERCEDES	6314200120	2157302
MERCEDES	6314200120	FVR941
MERCEDES	6314200172	09.7157.10
MERCEDES	6314200220	2157302
MERCEDES	6314200220	FVR941
MERCEDES	6314200320	2157302
MERCEDES	6314200320	FVR941
MERCEDES	6314200372	08.5181.10
MERCEDES	6314200483	EFR067
MERCEDES	6314200583	EFR068
MERCEDES	6314201083	EFR067
MERCEDES	6314201183	EFR068
MERCEDES	6314203283	EFR067
MERCEDES	6314203383	EFR068
MERCEDES	6384210112	09.6983.10
MERCEDES	6384230112	08.6968.10
MERCEDES	6394210012	09.8404.10
MERCEDES	6394210012	93123400
MERCEDES	6394210212	93123400
MERCEDES	6394210312	93123400
MERCEDES	6394230112	08.8405.10
MERCEDES	6394230112	93123503
MERCEDES	6395401417	98033800
MERCEDES	6395401517	98033800
MERCEDES	6674202901	EFR053
MERCEDES	6674203001	EFR054
MERCEDES	6674203101	EFR047
MERCEDES	6674203201	EFR048
MERCEDES	6674203501	EFR053
MERCEDES	6674203601	EFR054
MERCEDES	6674203701	EFR053
MERCEDES	6674203801	EFR054
MERCEDES	6674206001	EFR053
MERCEDES	6674206101	EFR054
MERCEDES	6674206201	EFR053
MERCEDES	6674206301	EFR054
MERCEDES	6684210112	09.6998.10
MERCEDES	6684210112	93087400
MERCEDES	6684210112	FCR118A
MERCEDES	6684210212	09.6969.10
MERCEDES	6684210212	93087600
MERCEDES	6684210212	FCR163A
MERCEDES	6684210612	09.6998.10
MERCEDES	6684210612	FCR118A
MERCEDES	6684230012	09.8206.10
MERCEDES	6684230012	93087500
MERCEDES	6684230012	FCR164A
MERCEDES	6684230112	09.8205.10
MERCEDES	6684230112	93087700
MERCEDES	6684230112	FCR165A
MERCEDES	6694200020	2983506
MERCEDES	6694200020	FVR1522B
MERCEDES	6694200120	2983506
MERCEDES	6694200120	FVR1522B

Les correspondances de références ont pour seul but la recherche de références;

The cross references are intended only to seek references;

CORRESPONDANCE DES REFERENCES CROSS LIST

MARQUE/MAKER	REF/PN OES	REF/PN
MERCEDES	6694201520	2983506
MERCEDES	6694201520	FVR1522B
MERCEDES	6694202001	EFR023
MERCEDES	6694202001	EFR122
MERCEDES	6694202101	EFR024
MERCEDES	6694202101	EFR123
MERCEDES	6694202401	EFR023
MERCEDES	6694202401	EFR122
MERCEDES	6694202501	EFR024
MERCEDES	6694202501	EFR123
MERCEDES	6694202601	EFR023
MERCEDES	6694202601	EFR122
MERCEDES	6694202701	EFR024
MERCEDES	6694202701	EFR123
MERCEDES	6694202801	EFR023
MERCEDES	6694202801	EFR122
MERCEDES	6694202901	EFR024
MERCEDES	6694202901	EFR123
MERCEDES	6694203001	EFR023
MERCEDES	6694203001	EFR122
MERCEDES	6694203101	EFR024
MERCEDES	6694203101	EFR123
MERCEDES	6694204401	EFR023
MERCEDES	6694204401	EFR122
MERCEDES	6694204501	EFR024
MERCEDES	6694204501	EFR123
MERCEDES	6694204601	EFR023
MERCEDES	6694204601	EFR122
MERCEDES	6694204701	EFR123
MERCEDES	6694205101	EFR031
MERCEDES	6694205201	EFR032
MERCEDES	6694206001	EFR023
MERCEDES	6694206101	EFR024
MERCEDES	6694210008	2078401
MERCEDES	6694210008	FVR239
MERCEDES	6694210108	2983506
MERCEDES	6694210108	FVR1522B
MERCEDES	6694210112	09.6998.10
MERCEDES	6694210112	93087400
MERCEDES	6694210112	FCR118A
MERCEDES	6694210512	93087800
MERCEDES	6694210612	09.6998.10
MERCEDES	6694210612	93087400
MERCEDES	6694210612	FCR118A
MERCEDES	6694210712	93087800
MERCEDES	6695400417	98012200
MERCEDES	6695400417	98022000
MERCEDES	6695400517	98012200
MERCEDES	6695400517	98022000
MERCEDES	6695400917	98026400
MERCEDES	6695401117	98022000
MERCEDES	6704200283	EFR033
MERCEDES	6704200383	EFR034
MERCEDES	6704202820	2983506
MERCEDES	6704202820	FVR1522B

MARQUE/MAKER	REF/PN OES	REF/PN
MERCEDES	6704204401	EFR025
MERCEDES	6704204501	EFR026
MERCEDES	6704204901	EFR031
MERCEDES	6704205001	EFR032
MERCEDES	6704205201	EFR033
MERCEDES	6704205301	EFR034
MERCEDES	6704205401	EFR025
MERCEDES	6704205501	EFR026
MERCEDES	6704205701	EFR033
MERCEDES	6704205801	EFR034
MERCEDES	6704206001	EFR031
MERCEDES	6704206101	EFR032
MERCEDES	6704206301	EFR033
MERCEDES	6704206401	EFR034
MERCEDES	6704206601	EFR031
MERCEDES	6704206701	EFR032
MERCEDES	6704206901	EFR033
MERCEDES	6704207001	EFR034
MERCEDES	6704207201	EFR025
MERCEDES	6704207301	EFR026
MERCEDES	6704210012	09.6969.10
MERCEDES	6704210012	93087600
MERCEDES	6704210012	FCR163A
MERCEDES	6704210112	09.6969.10
MERCEDES	6704210112	93087600
MERCEDES	6704210112	FCR163A
MERCEDES	6704210312	09.6969.10
MERCEDES	6704210312	93087600
MERCEDES	6704210312	FCR163A
MERCEDES	6705400017	98016900
MERCEDES	9014200120	91055100
MERCEDES	9014200120	MP0574
MERCEDES	9014200302	EFR174
MERCEDES	9014200320	91055100
MERCEDES	9014200320	MP0574
MERCEDES	9014200402	EFR175
MERCEDES	9014200502	EFR174
MERCEDES	9014200520	91055100
MERCEDES	9014200520	MP0574
MERCEDES	9014200602	EFR175
MERCEDES	9014202202	EFR174
MERCEDES	9014202302	EFR175
MERCEDES	9014210110	2915301
MERCEDES	9014210110	FVR1879
MERCEDES	9014210410	2399002
MERCEDES	9014210410	FVR1038
MERCEDES	9014210510	2399002
MERCEDES	9014210510	FVR1038
MERCEDES	9014210610	2399002
MERCEDES	9014210610	FVR1038
MERCEDES	9014230412	08.7724.10
MERCEDES	9014230612	08.7724.10
MERCEDES	9014230812	08.7724.20
MERCEDES	9014230812	92137503
MERCEDES	9014230812	FCR230A

Les correspondances de références ont pour seul but la recherche de références;

The cross references are intended only to seek references;

CORRESPONDANCE DES REFERENCES CROSS LIST

MARQUE/MAKER	REF/PN OES	REF/PN
MERCEDES	9014231012	08.7724.20
MERCEDES	9014231012	92137503
MERCEDES	9014231012	FCR230A
MERCEDES	9015400017	98018200
MERCEDES	9015400117	98018200
MERCEDES	9015400217	98031700
MERCEDES	9015400317	98031700
MERCEDES	9024200502	EFR170
MERCEDES	9024200602	EFR171
MERCEDES	9024201101	EFR051
MERCEDES	9024201201	EFR052
MERCEDES	9024210110	2915301
MERCEDES	9024210110	FVR1879
MERCEDES	9024210312	09.7314.14
MERCEDES	9024210312	92131503
MERCEDES	9024210412	09.7314.14
MERCEDES	9024210412	92131503
MERCEDES	9024210612	09.7314.14
MERCEDES	9024210612	92131503
MERCEDES	9024210712	09.7314.24
MERCEDES	9024230112	08.7725.10
MERCEDES	9024230112	92137603
MERCEDES	9024230312	08.7725.10
MERCEDES	9024230312	92137603
MERCEDES	9024230412	08.7725.20
MERCEDES	9024230412	92137603
MERCEDES	9024230412	FCR229A
MERCEDES	9024230510	2390101
MERCEDES	9024230510	FVR1876
MERCEDES	9024230510KZ	2390101
MERCEDES	9024230510KZ	FVR1876
MERCEDES	9024230512	92137603
MERCEDES	9024230512	FCR229A
MERCEDES	9024230612	92137603
MERCEDES	9024230612	FCR229A
MERCEDES	9034210012	09.A922.14
MERCEDES	9034210112	09.A922.14
MERCEDES	9044200101	EFR095
MERCEDES	9044200201	EFR096
MERCEDES	9044200220	91057900
MERCEDES	9044200220	MP0594
MERCEDES	9044200320	91057900
MERCEDES	9044200320	MP0594
MERCEDES	9044200420	91057900
MERCEDES	9044200420	MP0594
MERCEDES	9044200801	EFR051
MERCEDES	9044200901	EFR052
MERCEDES	9044201801	EFR128
MERCEDES	9044201901	EFR129
MERCEDES	9044230212	09.8475.10
MERCEDES	9044230212	92089803
MERCEDES	9044230212	FCR191A
MERCEDES	9044230312	09.8475.10
MERCEDES	9044230312	92089803
MERCEDES	9044230312	FCR191A

MARQUE/MAKER	REF/PN OES	REF/PN
MERCEDES	9044230512	09.8475.10
MERCEDES	9044230512	92089803
MERCEDES	9044230512	FCR191A
MERCEDES	9054200020	2983506
MERCEDES	9054200020	FVR1522B
MERCEDES	9054201301	EFR108
MERCEDES	9054201401	EFR109
MERCEDES	9054201501	522.7301.50
MERCEDES	9054201601	522.7301.60
MERCEDES	9054202301	522.7301.50
MERCEDES	9054202401	522.7301.60
MERCEDES	9064200220	91069000
MERCEDES	9064200220	MP0678SA
MERCEDES	9064200320	91066800
MERCEDES	9064200320	MP0655
MERCEDES	9064200420	91069000
MERCEDES	9064200420	MP0678SA
MERCEDES	9064202085	CFM012
MERCEDES	9064203085	CFM013
MERCEDES	9064203185	CFM015
MERCEDES	9064204485	CFM014
MERCEDES	9064204585	CFM016
MERCEDES	9064210010	2919202
MERCEDES	9064210010	FVR1778
MERCEDES	9064210012	09.9508.14
MERCEDES	9064210012	93143200
MERCEDES	9064210012	FCR310A
MERCEDES	9064210112	09.9508.14
MERCEDES	9064210112	93143200
MERCEDES	9064210112	FCR310A
MERCEDES	9064210212	09.9508.14
MERCEDES	9064210212	93143200
MERCEDES	9064210212	FCR310A
MERCEDES	9064210300	2920002
MERCEDES	9064210300	FVR1777
MERCEDES	9064210400	2919202
MERCEDES	9064210400	FVR1778
MERCEDES	9064230012	08.9509.14
MERCEDES	9064230012	93143300
MERCEDES	9064230012	FCR311A
MERCEDES	9064230112	09.9510.14
MERCEDES	9064230112	93143403
MERCEDES	9064230112	FCR312A
MERCEDES	9065401317	98036500
MERCEDES	9065401417	98033700
MERCEDES	9065401517	98033700
MERCEDES	9104204000	2919202
MERCEDES	9104204000	FVR1778
MERCEDES	A0004200079	EFR025
MERCEDES	A0004200120	2302201
MERCEDES	A0004200179	EFR026
MERCEDES	A0004207520	2958104
MERCEDES	A0004207520	FDB143
MERCEDES	A0004208901	EFR053
MERCEDES	A0004209001	EFR054

Les correspondances de références ont pour seul but la recherche de références;

The cross references are intended only to seek references;

CORRESPONDANCE DES REFERENCES CROSS LIST

MARQUE/MAKER	REF/PN OES	REF/PN
MERCEDES	A0004209101	EFR053
MERCEDES	A0004209201	EFR054
MERCEDES	A0004209220	2932403
MERCEDES	A0004209220	2976402
MERCEDES	A0004209220	FCV958
MERCEDES	A0004209301	EFR053
MERCEDES	A0004209401	EFR054
MERCEDES	A0004209720	2302101
MERCEDES	A0004212410	2473901
MERCEDES	A0004212410	FVR1039
MERCEDES	A0004214110	2302201
MERCEDES	A0004216110	2400701
MERCEDES	A0004216210	2400801
MERCEDES	A0004237110	2915301
MERCEDES	A0004237110	FVR1879
MERCEDES	A0004314701	MC0093
MERCEDES	A0004314701	MC0308
MERCEDES	A0004315601	MC0093
MERCEDES	A0004315601	MC0308
MERCEDES	A0004315701	MC0093
MERCEDES	A0004315701	MC0308
MERCEDES	A0004316301	MC0473
MERCEDES	A0004316401	MC0093
MERCEDES	A0004316401	MC0308
MERCEDES	A0004316501	MC0093
MERCEDES	A0004316501	MC0308
MERCEDES	A0004317001	MC0616
MERCEDES	A0004317101	MC0617
MERCEDES	A0005400217	98021302
MERCEDES	A0005868942	2078401
MERCEDES	A0005868942	FVR239
MERCEDES	A0014200920	2958104
MERCEDES	A0014200920	FDB143
MERCEDES	A0014201420	2078401
MERCEDES	A0014201420	FVR239
MERCEDES	A0014201520	2983506
MERCEDES	A0014201520	FVR1522B
MERCEDES	A0014203401	EFR031
MERCEDES	A0014203501	EFR032
MERCEDES	A0014206983	EFR095
MERCEDES	A0014207083	EFR096
MERCEDES	A0014208683	EFR051
MERCEDES	A0014208783	EFR052
MERCEDES	A0014208820	2976402
MERCEDES	A0014208820	FCV958
MERCEDES	A0014209020	2932403
MERCEDES	A0014209020	2976402
MERCEDES	A0014209020	FCV958
MERCEDES	A0014209120	2976502
MERCEDES	A0014209120	FCV959
MERCEDES	A0014209220	2958104
MERCEDES	A0014209220	FDB143
MERCEDES	A0014210910	2400701
MERCEDES	A0014211010	2400801
MERCEDES	A0014219898	EFR110

MARQUE/MAKER	REF/PN OES	REF/PN
MERCEDES	A0014219998	EFR111
MERCEDES	A0015866042	2932403
MERCEDES	A0015866042	2976402
MERCEDES	A0015866042	FCV958
MERCEDES	A0015866342	2958104
MERCEDES	A0015866342	FDB143
MERCEDES	A0015867042	2078401
MERCEDES	A0015867042	FVR239
MERCEDES	A0015868942	2078401
MERCEDES	A0015868942	FVR239
MERCEDES	A0024201083	EFR170
MERCEDES	A0024201183	EFR171
MERCEDES	A0024201320	2976402
MERCEDES	A0024201320	FCV958
MERCEDES	A0024201420	2976502
MERCEDES	A0024201420	FCV959
MERCEDES	A0024201720	2958105
MERCEDES	A0024202420	2958105
MERCEDES	A0024202920	2976402
MERCEDES	A0024202920	FCV958
MERCEDES	A0024202983	EFR174
MERCEDES	A0024203083	EFR175
MERCEDES	A0024203483	EFR126
MERCEDES	A0024203583	EFR127
MERCEDES	A0024203820	2473901
MERCEDES	A0024203820	FVR1039
MERCEDES	A0024203920	2399002
MERCEDES	A0024203920	FVR1038
MERCEDES	A0024204020	2390101
MERCEDES	A0024204020	FVR1876
MERCEDES	A0024204098	EFR053
MERCEDES	A0024204120	2915301
MERCEDES	A0024204120	FVR1879
MERCEDES	A0024204198	EFR054
MERCEDES	A0024204220	2915301
MERCEDES	A0024204220	FVR1879
MERCEDES	A0024205620	2473901
MERCEDES	A0024205620	FVR1039
MERCEDES	A0024205720	2983506
MERCEDES	A0024205720	FVR1522B
MERCEDES	A0024205783	EFR095
MERCEDES	A0024205820	91055100
MERCEDES	A0024205820	MP0574
MERCEDES	A0024205883	EFR096
MERCEDES	A0024205920	91057900
MERCEDES	A0024205920	MP0594
MERCEDES	A0024206020	2390101
MERCEDES	A0024206020	FVR1876
MERCEDES	A0024206220	2983506
MERCEDES	A0024206220	FVR1522B
MERCEDES	A0024206920	2473901
MERCEDES	A0024206920	FVR1039
MERCEDES	A0024209920	2399002
MERCEDES	A0024209920	FVR1038
MERCEDES	A0024210098	EFR114

Les correspondances de références ont pour seul but la recherche de références;

The cross references are intended only to seek references;

CORRESPONDANCE DES REFERENCES CROSS LIST

MARQUE/MAKER	REF/PN OES	REF/PN
MERCEDES	A0024210198	EFR115
MERCEDES	A0024213898	EFR055
MERCEDES	A0024213998	EFR056
MERCEDES	A0024214098	EFR053
MERCEDES	A0024214198	EFR054
MERCEDES	A0024231198	EFR107
MERCEDES	A0024231298	EFR086
MERCEDES	A0024231298	EFR106
MERCEDES	A0034200120	2302201
MERCEDES	A0034200720	2078401
MERCEDES	A0034200720	FVR239
MERCEDES	A0034201420	91055100
MERCEDES	A0034201420	MP0574
MERCEDES	A0034201520	2983506
MERCEDES	A0034201520	FVR1522B
MERCEDES	A0034201720	2915301
MERCEDES	A0034201720	FVR1879
MERCEDES	A0034202083	EFR093
MERCEDES	A0034202420	2302101
MERCEDES	A0034203383	EFR094
MERCEDES	A0034203420	91055100
MERCEDES	A0034203420	MP0574
MERCEDES	A0034203483	EFR085
MERCEDES	A0034203620	2958104
MERCEDES	A0034203620	FDB143
MERCEDES	A0034203720	2958105
MERCEDES	A0034203820	2958105
MERCEDES	A0034204420	2983506
MERCEDES	A0034204420	FVR1522B
MERCEDES	A0034204620	2923701
MERCEDES	A0034204620	507.7304.18
MERCEDES	A0034204620	FVR1791
MERCEDES	A0034206420	2473901
MERCEDES	A0034206420	FVR1039
MERCEDES	A0034207183	EFR073
MERCEDES	A0034207283	EFR074
MERCEDES	A0034207383	EFR075
MERCEDES	A0034207420	2958104
MERCEDES	A0034207420	2976502
MERCEDES	A0034207420	FCV959
MERCEDES	A0034207420	FDB143
MERCEDES	A0034207483	EFR076
MERCEDES	A0034207520	2958105
MERCEDES	A0034207620	2958105
MERCEDES	A0034207720	2983506
MERCEDES	A0034207720	FVR1522B
MERCEDES	A0034207820	2400701
MERCEDES	A0034207910	2400701
MERCEDES	A0034208583	EFR065
MERCEDES	A0034208683	EFR066
MERCEDES	A0034208783	EFR077
MERCEDES	A0034208883	EFR078
MERCEDES	A0034213998	EFR053
MERCEDES	A0034214098	EFR054
MERCEDES	A0034214198	EFR055

MARQUE/MAKER	REF/PN OES	REF/PN
MERCEDES	A0034214298	EFR056
MERCEDES	A0034214398	EFR055
MERCEDES	A0034214498	EFR056
MERCEDES	A0034214598	EFR053
MERCEDES	A0034214698	EFR054
MERCEDES	A0034214798	EFR053
MERCEDES	A0034214898	EFR054
MERCEDES	A0034214998	EFR055
MERCEDES	A0034215098	EFR056
MERCEDES	A0034302801	MC0620
MERCEDES	A0034307901	MC0618
MERCEDES	A0034308201	MC0618
MERCEDES	A0044201420	2078401
MERCEDES	A0044201420	FVR239
MERCEDES	A0044201520	2915301
MERCEDES	A0044201520	FVR1879
MERCEDES	A0044202420	2915301
MERCEDES	A0044202420	FVR1879
MERCEDES	A0044202520	2302101
MERCEDES	A0044202620	2915301
MERCEDES	A0044202620	FVR1879
MERCEDES	A0044202720	2390101
MERCEDES	A0044202720	FVR1876
MERCEDES	A0044204383	EFR116
MERCEDES	A0044204483	EFR110
MERCEDES	A0044204583	EFR114
MERCEDES	A0044204820	2983506
MERCEDES	A0044204820	FVR1522B
MERCEDES	A0044204883	EFR117
MERCEDES	A0044204983	EFR111
MERCEDES	A0044205083	EFR115
MERCEDES	A0044205520	2399002
MERCEDES	A0044205520	FVR1038
MERCEDES	A0044205583	EFR065
MERCEDES	A0044205620	2473901
MERCEDES	A0044205620	FVR1039
MERCEDES	A0044205683	EFR066
MERCEDES	A0044205783	EFR077
MERCEDES	A0044205883	EFR078
MERCEDES	A0044206820	2920002
MERCEDES	A0044206820	FVR1777
MERCEDES	A0044206920	2919001
MERCEDES	A0044206920	FVR1780
MERCEDES	A0044208120	2921702
MERCEDES	A0044208120	FVR1779
MERCEDES	A0044208120	FVR4429
MERCEDES	A0044208220	2920002
MERCEDES	A0044208220	FVR1777
MERCEDES	A0044208320	2919202
MERCEDES	A0044208320	FVR1778
MERCEDES	A0044217898	EFR053
MERCEDES	A0044217998	EFR054
MERCEDES	A0044218298	EFR055
MERCEDES	A0044218398	EFR056
MERCEDES	A0044302801	MC0620

Les correspondances de références ont pour seul but la recherche de références;

The cross references are intended only to seek references;

CORRESPONDANCE DES REFERENCES CROSS LIST

MARQUE/MAKER	REF/PN OES	REF/PN
MERCEDES	A0044303001	MC0618
MERCEDES	A0054202120	2919202
MERCEDES	A0054202120	FVR1778
MERCEDES	A0054205220	2919202
MERCEDES	A0054205220	FVR1778
MERCEDES	A0054205320	2920002
MERCEDES	A0054205320	FVR1777
MERCEDES	A0054207020	2919202
MERCEDES	A0054207020	FVR1778
MERCEDES	A0054207420	2921702
MERCEDES	A0054207420	FVR1779
MERCEDES	A0054207420	FVR4429
MERCEDES	A0054208118	CR0581
MERCEDES	A0054208620	2915301
MERCEDES	A0054208620	FVR1879
MERCEDES	A0054209820	2078401
MERCEDES	A0054209820	FVR239
MERCEDES	A0064202220	2921702
MERCEDES	A0064202220	FVR1779
MERCEDES	A0064202220	FVR4429
MERCEDES	A0064204320	2400701
MERCEDES	A0064204420	2400801
MERCEDES	A0064204520	2921702
MERCEDES	A0064204520	FVR1779
MERCEDES	A0064204520	FVR4429
MERCEDES	A0064208420	2919202
MERCEDES	A0064208420	FVR1778
MERCEDES	A0064211798	EFR055
MERCEDES	A0064211898	EFR056
MERCEDES	A0064211998	EFR055
MERCEDES	A0064212098	EFR056
MERCEDES	A0064212198	EFR053
MERCEDES	A0064212298	EFR054
MERCEDES	A0064212398	EFR053
MERCEDES	A0064212498	EFR054
MERCEDES	A0064212998	EFR055
MERCEDES	A0064213098	EFR056
MERCEDES	A0064213198	EFR055
MERCEDES	A0064213298	EFR056
MERCEDES	A0074210498	EFR085
MERCEDES	A0074211598	EFR055
MERCEDES	A0074211698	EFR056
MERCEDES	A0074213198	EFR055
MERCEDES	A0074213298	EFR056
MERCEDES	A0074218398	EFR053
MERCEDES	A0074218498	EFR054
MERCEDES	A0084204218	CR0581
MERCEDES	A0084204620	2915301
MERCEDES	A0084204620	FVR1879
MERCEDES	A0084204920	2915301
MERCEDES	A0084204920	FVR1879
MERCEDES	A0084211898	EFR053
MERCEDES	A0084211998	EFR054
MERCEDES	A0084212098	EFR053
MERCEDES	A0084212198	EFR054

MARQUE/MAKER	REF/PN OES	REF/PN
MERCEDES	A035401217	98016800
MERCEDES	A1004200473	08.6923.20
MERCEDES	A1004200473	93054600
MERCEDES	A1004200473	FCR117A
MERCEDES	A1004200873	08.6923.20
MERCEDES	A1004200873	93054600
MERCEDES	A1004200873	FCR117A
MERCEDES	A1265402017	98021302
MERCEDES	A34203620	2958104
MERCEDES	A34203620	FDB143
MERCEDES	A4054210298	EFR116
MERCEDES	A4054210398	EFR117
MERCEDES	A4054210698	EFR116
MERCEDES	A4054210798	EFR117
MERCEDES	A4164210098	EFR093
MERCEDES	A4164210198	EFR085
MERCEDES	A4164210298	EFR107
MERCEDES	A4164210398	EFR086
MERCEDES	A4164210398	EFR106
MERCEDES	A4164210412	08.6750.20
MERCEDES	A4164210412	93015500
MERCEDES	A4164210412	FCR364A
MERCEDES	A4164210598	EFR094
MERCEDES	A4164210698	EFR107
MERCEDES	A4164210798	EFR086
MERCEDES	A4164210798	EFR106
MERCEDES	A4174210012	08.6750.10
MERCEDES	A4174210012	93066400
MERCEDES	A4174210012	FCR156A
MERCEDES	A4184210198	EFR116
MERCEDES	A4184210298	EFR117
MERCEDES	A4194210098	EFR093
MERCEDES	A4194210198	EFR085
MERCEDES	A4194210298	EFR094
MERCEDES	A4194210498	EFR107
MERCEDES	A4194210598	EFR086
MERCEDES	A4194210598	EFR106
MERCEDES	A4194210698	EFR093
MERCEDES	A4194210798	EFR094
MERCEDES	A4194210898	EFR085
MERCEDES	A4194211098	EFR086
MERCEDES	A4194211098	EFR106
MERCEDES	A4194211198	EFR107
MERCEDES	A4194211298	EFR086
MERCEDES	A4254210012	93025600
MERCEDES	A4274210098	EFR093
MERCEDES	A4274210198	EFR085
MERCEDES	A4274210298	EFR094
MERCEDES	A4274210498	EFR107
MERCEDES	A4274210598	EFR086
MERCEDES	A4274210598	EFR106
MERCEDES	A4274211798	EFR114
MERCEDES	A4274211898	EFR115
MERCEDES	A4274211998	EFR093
MERCEDES	A4274212098	EFR094

Les correspondances de références ont pour seul but la recherche de références;

The cross references are intended only to seek references;

CORRESPONDANCE DES REFERENCES CROSS LIST

MARQUE/MAKER	REF/PN OES	REF/PN
MERCEDES	A4274212198	EFR085
MERCEDES	A4274212398	EFR086
MERCEDES	A4274212398	EFR106
MERCEDES	A4274212498	EFR107
MERCEDES	A4354210498	EFR086
MERCEDES	A4354210498	EFR106
MERCEDES	A4354210598	EFR107
MERCEDES	A4354211498	EFR085
MERCEDES	A4355420017	98022100
MERCEDES	A4374210198	EFR110
MERCEDES	A4374210298	EFR111
MERCEDES	A4374210498	EFR114
MERCEDES	A4374210598	EFR115
MERCEDES	A4374210798	EFR110
MERCEDES	A4374210898	EFR111
MERCEDES	A4374211098	EFR114
MERCEDES	A4374211198	EFR115
MERCEDES	A4374211298	EFR110
MERCEDES	A4374211398	EFR111
MERCEDES	A4374211498	EFR114
MERCEDES	A4374211598	EFR115
MERCEDES	A4374211698	EFR110
MERCEDES	A4374211798	EFR111
MERCEDES	A4374211898	EFR114
MERCEDES	A4374211998	EFR115
MERCEDES	A4374212298	EFR116
MERCEDES	A4374212398	EFR117
MERCEDES	A4374212598	EFR116
MERCEDES	A4374212698	EFR117
MERCEDES	A4404210098	EFR093
MERCEDES	A4404210198	EFR094
MERCEDES	A4404210298	EFR085
MERCEDES	A4604200020	2078401
MERCEDES	A4604200020	FVR239
MERCEDES	A5420742028	2921702
MERCEDES	A5420742028	FVR1779
MERCEDES	A5420742028	FVR4429
MERCEDES	A6014200072	08.3959.20
MERCEDES	A6014200072	93012400
MERCEDES	A6014200072	FCR116A
MERCEDES	A6014200172	08.6923.20
MERCEDES	A6014200172	93054600
MERCEDES	A6014200172	FCR117A
MERCEDES	A6014200272	08.3959.20
MERCEDES	A6014200272	93012400
MERCEDES	A6014200272	FCR116A
MERCEDES	A6014200372	08.6923.20
MERCEDES	A6014200372	93054600
MERCEDES	A6014200372	FCR117A
MERCEDES	A6014207620	2078401
MERCEDES	A6014207620	FVR239
MERCEDES	A6014208720	2078401
MERCEDES	A6014208720	FVR239
MERCEDES	A6014210312	08.6923.20

MARQUE/MAKER	REF/PN OES	REF/PN
MERCEDES	A6014210312	93054600
MERCEDES	A6014210312	FCR117A
MERCEDES	A6014210408	2078401
MERCEDES	A6014210408	FVR239
MERCEDES	A6014210412	08.3959.20
MERCEDES	A6014210412	93012400
MERCEDES	A6014210412	FCR116A
MERCEDES	A6014210512	08.6923.20
MERCEDES	A6014210512	93054600
MERCEDES	A6014210512	FCR117A
MERCEDES	A6014210608	2078401
MERCEDES	A6014210608	FVR239
MERCEDES	A6014215012	08.3959.20
MERCEDES	A6014215012	93012400
MERCEDES	A6014215012	FCR116A
MERCEDES	A6014215112	08.3959.20
MERCEDES	A6014215112	93012400
MERCEDES	A6014215112	FCR116A
MERCEDES	A6014217720	2157302
MERCEDES	A6014217720	FVR941
MERCEDES	A6015400617	98016800
MERCEDES	A6015401317	98021302
MERCEDES	A6015860042	2078401
MERCEDES	A6015860042	FVR239
MERCEDES	A6314200020	2157302
MERCEDES	A6314200020	FVR941
MERCEDES	A6314200120	2157302
MERCEDES	A6314200120	FVR941
MERCEDES	A6314200220	2157302
MERCEDES	A6314200220	FVR941
MERCEDES	A6314200320	2157302
MERCEDES	A6314200320	FVR941
MERCEDES	A6314200483	EFR067
MERCEDES	A6314200583	EFR068
MERCEDES	A6314201083	EFR067
MERCEDES	A6314201183	EFR068
MERCEDES	A6314203283	EFR067
MERCEDES	A6314203383	EFR068
MERCEDES	A6394210012	93123400
MERCEDES	A6394210212	93123400
MERCEDES	A6394210312	93123400
MERCEDES	A6394230112	93123503
MERCEDES	A6395401417	98033800
MERCEDES	A6395401517	98033800
MERCEDES	A6674202901	EFR053
MERCEDES	A6674203001	EFR054
MERCEDES	A6674203101	EFR047
MERCEDES	A6674203201	EFR048
MERCEDES	A6674203501	EFR053
MERCEDES	A6674203601	EFR054
MERCEDES	A6674203701	EFR053
MERCEDES	A6674203801	EFR054
MERCEDES	A6674206001	EFR053
MERCEDES	A6674206101	EFR054

CORRESPONDANCE DES REFERENCES CROSS LIST

MARQUE/MAKER	REF/PN OES	REF/PN
MERCEDES	A6674206201	EFR053
MERCEDES	A6674206301	EFR054
MERCEDES	A6684210112	09.6998.10
MERCEDES	A6684210112	93087400
MERCEDES	A6684210112	FCR118A
MERCEDES	A6684210212	09.6969.10
MERCEDES	A6684210212	93087600
MERCEDES	A6684210212	FCR163A
MERCEDES	A6684210612	09.6998.10
MERCEDES	A6684210612	FCR118A
MERCEDES	A6684230012	09.8206.10
MERCEDES	A6684230012	93087500
MERCEDES	A6684230012	FCR164A
MERCEDES	A6684230112	09.8205.10
MERCEDES	A6684230112	93087700
MERCEDES	A6684230112	FCR165A
MERCEDES	A6694200020	2983506
MERCEDES	A6694200020	FVR1522B
MERCEDES	A6694200120	2983506
MERCEDES	A6694200120	FVR1522B
MERCEDES	A6694201520	2983506
MERCEDES	A6694201520	FVR1522B
MERCEDES	A6694202001	EFR023
MERCEDES	A6694202001	EFR122
MERCEDES	A6694202101	EFR024
MERCEDES	A6694202101	EFR123
MERCEDES	A6694202401	EFR023
MERCEDES	A6694202401	EFR122
MERCEDES	A6694202501	EFR024
MERCEDES	A6694202501	EFR123
MERCEDES	A6694202601	EFR023
MERCEDES	A6694202601	EFR122
MERCEDES	A6694202701	EFR024
MERCEDES	A6694202701	EFR123
MERCEDES	A6694202801	EFR023
MERCEDES	A6694202801	EFR122
MERCEDES	A6694202901	EFR024
MERCEDES	A6694202901	EFR123
MERCEDES	A6694203001	EFR023
MERCEDES	A6694203001	EFR122
MERCEDES	A6694203101	EFR024
MERCEDES	A6694203101	EFR123
MERCEDES	A6694204401	EFR023
MERCEDES	A6694204401	EFR122
MERCEDES	A6694204501	EFR024
MERCEDES	A6694204501	EFR123
MERCEDES	A6694204601	EFR023
MERCEDES	A6694204601	EFR122
MERCEDES	A6694204701	EFR123
MERCEDES	A6694205101	EFR031
MERCEDES	A6694205201	EFR032
MERCEDES	A6694206001	EFR023
MERCEDES	A6694206101	EFR024
MERCEDES	A6694210008	2078401
MERCEDES	A6694210008	FVR239

MARQUE/MAKER	REF/PN OES	REF/PN
MERCEDES	A6694210108	2983506
MERCEDES	A6694210108	FVR1522B
MERCEDES	A6694210112	09.6998.10
MERCEDES	A6694210112	93087400
MERCEDES	A6694210112	FCR118A
MERCEDES	A6694210512	93087800
MERCEDES	A6694210612	09.6998.10
MERCEDES	A6694210612	93087400
MERCEDES	A6694210612	FCR118A
MERCEDES	A6694210712	93087800
MERCEDES	A6695400417	98012200
MERCEDES	A6695400417	98022000
MERCEDES	A6695400517	98012200
MERCEDES	A6695400517	98022000
MERCEDES	A6695400917	98026400
MERCEDES	A6695401117	98022000
MERCEDES	A6704200283	EFR033
MERCEDES	A6704200383	EFR034
MERCEDES	A6704202820	2983506
MERCEDES	A6704202820	FVR1522B
MERCEDES	A6704204401	EFR025
MERCEDES	A6704204501	EFR026
MERCEDES	A6704204901	EFR031
MERCEDES	A6704205001	EFR032
MERCEDES	A6704205201	EFR033
MERCEDES	A6704205301	EFR034
MERCEDES	A6704205401	EFR025
MERCEDES	A6704205501	EFR026
MERCEDES	A6704205701	EFR033
MERCEDES	A6704205801	EFR034
MERCEDES	A6704206001	EFR031
MERCEDES	A6704206101	EFR032
MERCEDES	A6704206301	EFR033
MERCEDES	A6704206401	EFR034
MERCEDES	A6704206601	EFR031
MERCEDES	A6704206701	EFR032
MERCEDES	A6704206901	EFR033
MERCEDES	A6704207001	EFR034
MERCEDES	A6704207201	EFR025
MERCEDES	A6704207301	EFR026
MERCEDES	A6704210012	93087600
MERCEDES	A6704210012	FCR163A
MERCEDES	A6704210112	09.6969.10
MERCEDES	A6704210112	93087600
MERCEDES	A6704210112	FCR163A
MERCEDES	A6704210312	09.6969.10
MERCEDES	A6704210312	93087600
MERCEDES	A6704210312	FCR163A
MERCEDES	A6705400017	98016900
MERCEDES	A9014200120	91055100
MERCEDES	A9014200120	MP0574
MERCEDES	A9014200302	EFR174
MERCEDES	A9014200320	91055100
MERCEDES	A9014200320	MP0574
MERCEDES	A9014200402	EFR175

Les correspondances de références ont pour seul but la recherche de références;

The cross references are intended only to seek references;

CORRESPONDANCE DES REFERENCES CROSS LIST

MARQUE/MAKER	REF/PN OES	REF/PN
MERCEDES	A9014200502	EFR174
MERCEDES	A9014200520	91055100
MERCEDES	A9014200520	MP0574
MERCEDES	A9014200602	EFR175
MERCEDES	A9014202202	EFR174
MERCEDES	A9014202302	EFR175
MERCEDES	A9014210110	2915301
MERCEDES	A9014210110	FVR1879
MERCEDES	A9014210410	2399002
MERCEDES	A9014210410	FVR1038
MERCEDES	A9014210510	2399002
MERCEDES	A9014210510	FVR1038
MERCEDES	A9014210610	2399002
MERCEDES	A9014210610	FVR1038
MERCEDES	A9014230412	08.7724.10
MERCEDES	A9014230612	08.7724.10
MERCEDES	A9014230812	08.7724.20
MERCEDES	A9014230812	92137503
MERCEDES	A9014230812	FCR230A
MERCEDES	A9014231012	08.7724.20
MERCEDES	A9014231012	92137503
MERCEDES	A9014231012	FCR230A
MERCEDES	A9015400017	98018200
MERCEDES	A9015400117	98018200
MERCEDES	A9015400217	98031700
MERCEDES	A9015400317	98031700
MERCEDES	A9024200502	EFR170
MERCEDES	A9024200602	EFR171
MERCEDES	A9024201101	EFR051
MERCEDES	A9024201201	EFR052
MERCEDES	A9024210110	2915301
MERCEDES	A9024210110	FVR1879
MERCEDES	A9024230112	08.7725.10
MERCEDES	A9024230312	08.7725.10
MERCEDES	A9024230412	92137603
MERCEDES	A9024230412	FCR229A
MERCEDES	A9024230510	2390101
MERCEDES	A9024230510	FVR1876
MERCEDES	A9024230510KZ	2390101
MERCEDES	A9024230510KZ	FVR1876
MERCEDES	A9024230512	92137603
MERCEDES	A9024230512	FCR229A
MERCEDES	A9024230612	92137603
MERCEDES	A9024230612	FCR229A
MERCEDES	A9034210012	09.A922.14
MERCEDES	A9034210112	09.A922.14
MERCEDES	A9044200101	EFR095
MERCEDES	A9044200201	EFR096
MERCEDES	A9044200220	91057900
MERCEDES	A9044200220	MP0594
MERCEDES	A9044200320	91057900
MERCEDES	A9044200320	MP0594
MERCEDES	A9044200420	91057900
MERCEDES	A9044200420	MP0594
MERCEDES	A9044200801	EFR051

MARQUE/MAKER	REF/PN OES	REF/PN
MERCEDES	A9044200901	EFR052
MERCEDES	A9044201801	EFR128
MERCEDES	A9044201901	EFR129
MERCEDES	A9044230212	09.8475.10
MERCEDES	A9044230212	92089803
MERCEDES	A9044230212	FCR191A
MERCEDES	A9044230312	09.8475.10
MERCEDES	A9044230312	92089803
MERCEDES	A9044230312	FCR191A
MERCEDES	A9044230512	09.8475.10
MERCEDES	A9044230512	92089803
MERCEDES	A9044230512	FCR191A
MERCEDES	A9054200020	2983506
MERCEDES	A9054200020	FVR1522B
MERCEDES	A9054201301	EFR108
MERCEDES	A9054201401	EFR109
MERCEDES	A9054201501	522.7301.50
MERCEDES	A9054201601	522.7301.60
MERCEDES	A9054202301	522.7301.50
MERCEDES	A9054202401	522.7301.60
MERCEDES	A9064200220	91069000
MERCEDES	A9064200220	MP0678SA
MERCEDES	A9064200320	91066800
MERCEDES	A9064200320	MP0655
MERCEDES	A9064200420	91069000
MERCEDES	A9064200420	MP0678SA
MERCEDES	A9064202085	CFM012
MERCEDES	A9064210010	2919202
MERCEDES	A9064210010	FVR1778
MERCEDES	A9064210012	09.9508.14
MERCEDES	A9064210012	93143200
MERCEDES	A9064210012	FCR310A
MERCEDES	A9064210112	09.9508.14
MERCEDES	A9064210112	93143200
MERCEDES	A9064210112	FCR310A
MERCEDES	A9064210212	09.9508.14
MERCEDES	A9064210212	93143200
MERCEDES	A9064210212	FCR310A
MERCEDES	A9064210300	2920002
MERCEDES	A9064210300	FVR1777
MERCEDES	A9064210400	2919202
MERCEDES	A9064210400	FVR1778
MERCEDES	A9064230012	08.9509.14
MERCEDES	A9064230012	93143300
MERCEDES	A9064230012	FCR311A
MERCEDES	A9064230112	09.9510.14
MERCEDES	A9064230112	93143403
MERCEDES	A9064230112	FCR312A
MERCEDES	A9065401317	98036500
MERCEDES	A9065401417	98033700
MERCEDES	A9065401517	98033700
MERCEDES	A9104204000	2919202
MERCEDES	A9104204000	FVR1778
MERITOR	68032056	EFR166
MERITOR	68032057	EFR167

Les correspondances de références ont pour seul but la recherche de références;

The cross references are intended only to seek references;

CORRESPONDANCE DES REFERENCES CROSS LIST

MARQUE/MAKER	REF/PN OES	REF/PN
MERITOR	68032094	EFR023
MERITOR	68032095	EFR024
MERITOR	68032096	EFR025
MERITOR	68032097	EFR026
MERITOR	68032134	EFR162
MERITOR	68032135	EFR163
MERITOR	68032138	EFR025
MERITOR	68032139	EFR026
MERITOR	68032140	EFR035
MERITOR	68032141	EFR036
MERITOR	68032142	EFR037
MERITOR	68032143	EFR038
MERITOR	68032188	EFR100
MERITOR	68032189	EFR101
MERITOR	68032190	EFR144
MERITOR	68032191	EFR145
MERITOR	68032205	EFR030
MERITOR	68032206	EFR027
MERITOR	68032207	EFR028
MERITOR	68032208	EFR158
MERITOR	68032209	EFR159
MERITOR	68032210	EFR134
MERITOR	68032260	EFR144
MERITOR	68032261	EFR145
MERITOR	68032262	EFR021
MERITOR	68032263	EFR022
MERITOR	68032264	EFR019
MERITOR	68032265	EFR020
MERITOR	68032266	EFR029
MERITOR	68032267	EFR030
MERITOR	68032268	EFR027
MERITOR	68032269	EFR028
MERITOR	68032270	EFR029
MERITOR	68032271	EFR030
MERITOR	68032272	EFR027
MERITOR	68032273	EFR028
MERITOR	68032274	EFR166
MERITOR	68032275	EFR167
MERITOR	68032276	EFR162
MERITOR	68032277	EFR163
MERITOR	68032278	EFR158
MERITOR	68032279	EFR159
MERITOR	68032280	EFR134
MERITOR	68032280	EFR135
MERITOR	68032281	EFR135
MERITOR	68032286	EFR037
MERITOR	68032287	EFR038
MERITOR	68032288	EFR035
MERITOR	68032289	EFR036
MERITOR	68032294	EFR023
MERITOR	68032295	EFR024
MERITOR	68032296	EFR025
MERITOR	68032297	EFR026
MERITOR	68032318	EFR021
MERITOR	68032319	EFR022

MARQUE/MAKER	REF/PN OES	REF/PN
MERITOR	68032320	EFR019
MERITOR	68032321	EFR020
MERITOR	68032401	EFR031
MERITOR	68032402	EFR032
MERITOR	68032403	EFR033
MERITOR	68032404	EFR034
MERITOR	68032545	EFR031
MERITOR	68032546	EFR032
MERITOR	68032547	EFR033
MERITOR	68032548	EFR034
MERITOR	68032609	EFR108
MERITOR	68032610	EFR109
MERITOR	68032839	EFR160
MERITOR	68032840	EFR161
MERITOR	68033134	EFR031
MERITOR	68033135	EFR032
MERITOR	68033138	EFR033
MERITOR	68033139	EFR034
MERITOR	68033321	EFR108
MERITOR	68033322	EFR109
MERITOR	68033325	EFR160
MERITOR	68033326	EFR161
MERITOR	68033327	EFR100
MERITOR	68033328	EFR101
MERITOR	68320614	98022000
MERITOR	68320874	98022200
MERITOR	68320909	98022200
MERITOR	LRG502	EFR019
MERITOR	LRG503	EFR020
MERITOR	LRG504	EFR021
MERITOR	LRG505	EFR022
MERITOR	LRG506	EFR162
MERITOR	LRG507	EFR163
MERITOR	LRG508	EFR166
MERITOR	LRG509	EFR167
MERITOR	LRG510	EFR023
MERITOR	LRG511	EFR024
MERITOR	LRG512	EFR160
MERITOR	LRG513	EFR161
MERITOR	LRG516	EFR035
MERITOR	LRG517	EFR036
MERITOR	LRG518	EFR037
MERITOR	LRG519	EFR038
MERITOR	LRG520	EFR025
MERITOR	LRG521	EFR026
MERITOR	LRG558	EFR025
MERITOR	LRG559	EFR026
MERITOR	LRG600	EFR144
MERITOR	LRG601	EFR145
MERITOR	LRG602	EFR100
MERITOR	LRG603	EFR101
MERITOR	LRG604	EFR027
MERITOR	LRG605	EFR028
MERITOR	LRG606	EFR029
MERITOR	LRG607	EFR030

Les correspondances de références ont pour seul but la recherche de références;

The cross references are intended only to seek references;

CORRESPONDANCE DES REFERENCES CROSS LIST

MARQUE/MAKER	REF/PN OES	REF/PN
MERITOR	LRG608	EFR027
MERITOR	LRG609	EFR028
MERITOR	LRG610	EFR029
MERITOR	LRG611	EFR030
MERITOR	LRG612	EFR134
MERITOR	LRG613	EFR135
MERITOR	LRG614	EFR158
MERITOR	LRG615	EFR159
MERITOR	LRG624	EFR031
MERITOR	LRG625	EFR032
MERITOR	LRG626	EFR033
MERITOR	LRG627	EFR034
MERITOR	LRG640	EFR108
MERITOR	LRG641	EFR109
MITSUBISHI	8973496890	CRB601
MITSUBISHI	8973496900	CRB602
MITSUBISHI	8973496910	CRB603
MITSUBISHI	8973496920	CRB604
MITSUBISHI	8973588780	CRB605
MITSUBISHI	8973588790	CRB606
MITSUBISHI	8973588800	CRB607
MITSUBISHI	8973588810	CRB608
MITSUBISHI	MC865957	2924201
MITSUBISHI	MC865957	FVR1906
MITSUBISHI	MC894263	91076100
MITSUBISHI	MC894589	2350101
MITSUBISHI	MC894601	2924201
MITSUBISHI	MC894601	FVR1906
MITSUBISHI	MC894604	2924201
MITSUBISHI	MC894604	FVR1906
MITSUBISHI	MK326388	EFR071
MITSUBISHI	MK326389	EFR072
MITSUBISHI	MK326390	EFR069
MITSUBISHI	MK326391	EFR070
MITSUBISHI	MK328619	2924201
MITSUBISHI	MK328619	FVR1906
MITSUBISHI	MK355371	2924201
MITSUBISHI	MK355371	FVR1906
MITSUBISHI	MK384894	2924201
MITSUBISHI	MK384894	FVR1906
MITSUBISHI	MK428211	EFR178
MITSUBISHI	MK428215	EFR176
MITSUBISHI	MK428216	EFR177
MITSUBISHI	MK448482	EFR179
MITSUBISHI	MK449107	2924001
MITSUBISHI	MK449107	FVR4253
MITSUBISHI	MK449108	2924001
MITSUBISHI	MK449108	2924901
MITSUBISHI	MK449108	FVR4253
MITSUBISHI	MK449108	FVR4314
MITSUBISHI	MK449937	2923801
MITSUBISHI	MK499871	2924201
MITSUBISHI	MK499871	FVR1906
MITSUBISHI	MK499872	2924201
MITSUBISHI	MK499872	FVR1906

MARQUE/MAKER	REF/PN OES	REF/PN
MITSUBISHI	MK499873	2350101
MITSUBISHI	MK499874	2924201
MITSUBISHI	MK499874	FVR1906
MITSUBISHI	MK499875	2924201
MITSUBISHI	MK499875	FVR1906
MITSUBISHI	MK499879	2924201
MITSUBISHI	MK499879	FVR1906
MITSUBISHI	MK528485	2924001
MITSUBISHI	MK528485	2924901
MITSUBISHI	MK528485	FVR4253
MITSUBISHI	MK528485	FVR4314
MITSUBISHI	MK528486	2924901
MITSUBISHI	MK528486	FVR4314
MITSUBISHI	MK528943	2923801
MITSUBISHI	MK528944	2924001
MITSUBISHI	MK528944	2924901
MITSUBISHI	MK528944	FVR4253
MITSUBISHI	MK528944	FVR4314
MITSUBISHI	MK528945	2924001
MITSUBISHI	MK528945	2924901
MITSUBISHI	MK528945	FVR4253
MITSUBISHI	MK528945	FVR4314
MITSUBISHI	MK528946	2924001
MITSUBISHI	MK528946	2924901
MITSUBISHI	MK528946	FVR4253
MITSUBISHI	MK528946	FVR4314
MITSUBISHI	MK529247	2923801
MITSUBISHI	MK529355	2924001
MITSUBISHI	MK529355	FVR4253
MITSUBISHI	MK529381	2923801
MITSUBISHI	MK529567	2923801
MITSUBISHI	MK529833	2924001
MITSUBISHI	MK529833	2924901
MITSUBISHI	MK529833	FVR4253
MITSUBISHI	MK529833	FVR4314
MITSUBISHI	MK529906	2924201
MITSUBISHI	MK529906	FVR1906
MITSUBISHI	MK529907	2924201
MITSUBISHI	MK529907	FVR1906
MITSUBISHI	MK529908	2924001
MITSUBISHI	MK529908	2924901
MITSUBISHI	MK529908	FVR4253
MITSUBISHI	MK529908	FVR4314
MITSUBISHI	MK529909	2924001
MITSUBISHI	MK529909	2924901
MITSUBISHI	MK529909	FVR4253
MITSUBISHI	MK529909	FVR4314
MITSUBISHI	MK529948	2924001
MITSUBISHI	MK529948	FVR4253
MITSUBISHI	MK529949	2924201
MITSUBISHI	MK529949	FVR1906
MITSUBISHI	MK530830	2924001
MITSUBISHI	MK530830	2924901
MITSUBISHI	MK530830	FVR4253
MITSUBISHI	MK530830	FVR4314

Les correspondances de références ont pour seul but la recherche de références;

The cross references are intended only to seek references;

CORRESPONDANCE DES REFERENCES CROSS LIST

MARQUE/MAKER	REF/PN OES	REF/PN
MULTICAR	03000820010	2915301
MULTICAR	03000820010	FVR1879
MULTICAR	10968	MC0620
MULTICAR	4010409	EFR118
MULTICAR	4010410	EFR119
MULTICAR	4013037	2920801
MULTICAR	4013037	FVR1761
NEOPLAN	11013270	MC0630
NISSAN	061004150	09.8495.10
NISSAN	061004200	09.8495.10
NISSAN	062003870	09.7263.30
NISSAN	062003870	FCR340A
NISSAN	062004380	09.8495.10
NISSAN	066005571-0	COR307
NISSAN	069008990	2998401
NISSAN	069008990	FVR792
NISSAN	069012170	CR1004
NISSAN	069030810	2907102
NISSAN	069030810	2998401
NISSAN	069030810	FVR627
NISSAN	069030810	FVR792
NISSAN	069030840	EFR082
NISSAN	069030850	EFR081
NISSAN	069052941	2907102
NISSAN	069052941	2998401
NISSAN	069052941	FVR627
NISSAN	069052941	FVR792
NISSAN	364529X503	CFM022
NISSAN	364529X50A	CFM021
NISSAN	364529X50B	CFM022
NISSAN	36530F3900	CFM018
NISSAN	36530F3904	CFM020
NISSAN	36530MB00B	CFM025
NISSAN	36531F3900	CFM017
NISSAN	36531F3904	CFM019
NISSAN	36531MB00B	CFM024
NISSAN	4020600Q0G	09.B633.10
NISSAN	4020600Q0G	92228600
NISSAN	4020600Q0G	DDF1974C-1
NISSAN	4020600QAC	08.9597.17
NISSAN	4020600QAC	92153703
NISSAN	4020600QAC	DDF1623-1
NISSAN	4020600QAD	09.9080.10
NISSAN	4020600QAD	92115903
NISSAN	4020600QAD	DDF1217C-1
NISSAN	4020600QAE	08.9597.17
NISSAN	4020600QAE	09.8937.10
NISSAN	4020600QAE	92116003
NISSAN	4020600QAE	92153703
NISSAN	4020600QAE	DDF1204C-1
NISSAN	4020600QAE	DDF1623-1
NISSAN	4020600QAF	08.9597.17
NISSAN	4020600QAF	09.8937.10
NISSAN	4020600QAF	92116003
NISSAN	4020600QAF	92153703

MARQUE/MAKER	REF/PN OES	REF/PN
NISSAN	4020600QAF	DDF1204C-1
NISSAN	4020600QAF	DDF1623-1
NISSAN	4020600QAG	08.9597.17
NISSAN	4020600QAG	09.8937.10
NISSAN	4020600QAG	92116003
NISSAN	4020600QAG	92153703
NISSAN	4020600QAG	DDF1204C-1
NISSAN	4020600QAG	DDF1623-1
NISSAN	4020600QAH	09.8937.10
NISSAN	4020600QAH	92116003
NISSAN	4020600QAH	DDF1204C-1
NISSAN	4020660U00	09.B497.10
NISSAN	4020660U00	93185303
NISSAN	4020660U01	09.B497.10
NISSAN	4020660U01	93185303
NISSAN	4020671U01	09.B497.10
NISSAN	4020671U01	93185303
NISSAN	402069X000	09.8495.10
NISSAN	402069X200	09.B497.10
NISSAN	402069X200	93185303
NISSAN	402069X401	09.8634.10
NISSAN	402069X403	09.8965.10
NISSAN	402069X403	93240600
NISSAN	402069X403	FCR339A
NISSAN	402069X404	09.8965.10
NISSAN	402069X404	93240600
NISSAN	402069X404	FCR339A
NISSAN	402069X405	09.8495.10
NISSAN	402069X406	09.8495.10
NISSAN	402069X407	09.8495.10
NISSAN	402069X40A	09.8495.10
NISSAN	402069X40B	09.8495.10
NISSAN	402069X500	09.8965.10
NISSAN	402069X500	93240600
NISSAN	402069X500	FCR339A
NISSAN	402069X60A	09.8965.10
NISSAN	402069X60A	93240600
NISSAN	402069X60A	FCR339A
NISSAN	40206F3902	92174603
NISSAN	40206F3904	92174603
NISSAN	40206G4800	92174603
NISSAN	40206MA50A	09.8965.10
NISSAN	40206MA50A	93240600
NISSAN	40206MA50A	FCR339A
NISSAN	40206MB600	09.B410.10
NISSAN	40206MB600	FCR326A
NISSAN	40206R8210	09.5232.10
NISSAN	402079X100	09.7263.30
NISSAN	402079X100	FCR340A
NISSAN	410009X200	EFR080
NISSAN	410009X201	EFR080
NISSAN	41000D6300	EFR160
NISSAN	41000D6301	EFR161
NISSAN	41000F3901	EFR081
NISSAN	41000F3902	EFR082

Les correspondances de références ont pour seul but la recherche de références;

The cross references are intended only to seek references;

CORRESPONDANCE DES REFERENCES CROSS LIST

MARQUE/MAKER	REF/PN OES	REF/PN
NISSAN	4100100Q0B	EFR016
NISSAN	4100100Q0K	EFR088
NISSAN	4100100Q0M	EFR088
NISSAN	4100100QAD	EFR010
NISSAN	4100100QAE	EFR008
NISSAN	4100100QAE	EFR012
NISSAN	4100100QAF	EFR016
NISSAN	410019X225	EFR080
NISSAN	410019X426	522.7301.84
NISSAN	41001MB200	522.7301.84
NISSAN	41001MB20A	522.7301.84
NISSAN	41001MB225	522.7301.84
NISSAN	41001MB600	522.9700.86
NISSAN	41001MB60A	522.9700.86
NISSAN	41001MB626	522.9700.86
NISSAN	410109X200	EFR079
NISSAN	410109X201	EFR079
NISSAN	4101100Q0B	EFR015
NISSAN	4101100Q0K	EFR087
NISSAN	4101100Q0M	EFR087
NISSAN	4101100QAD	EFR009
NISSAN	4101100QAE	EFR007
NISSAN	4101100QAE	EFR011
NISSAN	4101100QAF	EFR015
NISSAN	410119X225	EFR079
NISSAN	410119X426	522.7301.74
NISSAN	41011MB200	522.7301.74
NISSAN	41011MB20A	522.7301.74
NISSAN	41011MB225	522.7301.74
NISSAN	41011MB600	522.9700.76
NISSAN	41011MB60A	522.9700.76
NISSAN	41011MB626	522.9700.76
NISSAN	4106000Q0L	2514701
NISSAN	4106000Q0L	FVR4347
NISSAN	4106000Q1E	2514701
NISSAN	4106000Q1E	FVR4347
NISSAN	4106000Q1H	2208701
NISSAN	4106000Q1H	FVR4840
NISSAN	4106000QAD	2361301
NISSAN	4106000QAD	FVR1452
NISSAN	4106000QAE	2309902
NISSAN	4106000QAE	FVR1515
NISSAN	410600X226	2343501
NISSAN	410600X226	FVR1616
NISSAN	410603T090	2926101
NISSAN	410606T290	2926101
NISSAN	410606T390	2926101
NISSAN	410609X126	2912113
NISSAN	410609X126	507.5944.54
NISSAN	410609X126	FVR4156
NISSAN	410609X127	2343501
NISSAN	410609X127	FVR1616
NISSAN	410609X129	2932701
NISSAN	410609X129	507.7304.25
NISSAN	410609X129	FVR4248

MARQUE/MAKER	REF/PN OES	REF/PN
NISSAN	410609X225	2343501
NISSAN	410609X225	FVR1616
NISSAN	410609X226	2343501
NISSAN	410609X226	FVR1616
NISSAN	410609X425	2906705
NISSAN	410609X425	507.5664.31
NISSAN	410609X425	FCV733
NISSAN	410609X525	2343501
NISSAN	410609X525	FVR1616
NISSAN	41060D6225	2343501
NISSAN	41060D6225	FVR1616
NISSAN	41060G490A	2907102
NISSAN	41060G490A	2998401
NISSAN	41060G490A	FVR627
NISSAN	41060G490A	FVR792
NISSAN	41060MB225	2932701
NISSAN	41060MB225	FVR4248
NISSAN	41060MB625	2932701
NISSAN	41060MB625	FVR4248
NISSAN	41060WK60J	2924001
NISSAN	41060WK60J	FVR4253
NISSAN	41060WK60K	2924001
NISSAN	41060WK60K	FVR4253
NISSAN	41060WK690	2924001
NISSAN	41060WK690	FVR4253
NISSAN	41060WK691	2924001
NISSAN	41060WK691	FVR4253
NISSAN	4320600Q0A	08.B829.10
NISSAN	4320600Q0A	92228700
NISSAN	4320600Q0A	DDF1975C
NISSAN	4320600Q0B	08.A651.10
NISSAN	4320600Q0B	92228800
NISSAN	4320600Q0B	DDF1976C
NISSAN	4320600Q0C	08.A650.10
NISSAN	4320600Q0C	92230800
NISSAN	4320600Q0C	DDF1977C
NISSAN	4320600Q0D	08.9597.17
NISSAN	4320600Q0D	92153703
NISSAN	4320600Q0D	DDF1623-1
NISSAN	4320600QAB	08.9597.17
NISSAN	4320600QAB	92153703
NISSAN	4320600QAB	DDF1623-1
NISSAN	4320600QAC	08.9597.17
NISSAN	4320600QAC	92153703
NISSAN	4320600QAC	DDF1623-1
NISSAN	4320600QAD	08.9597.17
NISSAN	4320600QAD	92153703
NISSAN	4320600QAD	DDF1623-1
NISSAN	4320600QAE	08.9597.17
NISSAN	4320600QAE	92153703
NISSAN	4320600QAE	DDF1623-1
NISSAN	432069X100	09.7263.30
NISSAN	432069X100	FCR340A
NISSAN	43206MA50A	09.7263.30
NISSAN	43206MA50A	FCR340A

Les correspondances de références ont pour seul but la recherche de références;

The cross references are intended only to seek references;

CORRESPONDANCE DES REFERENCES CROSS LIST

MARQUE/MAKER	REF/PN OES	REF/PN
NISSAN	43206MB600	08.9794.10
NISSAN	43206MB600	FCR327A
NISSAN	43206MB60A	08.9794.60
NISSAN	43206MB60A	FCR369A
NISSAN	432079X100	09.7263.30
NISSAN	432079X100	FCR340A
NISSAN	440009X103	527.5960.87
NISSAN	4400100Q0A	EFR018
NISSAN	4400100Q0C	EFR090
NISSAN	4400100Q0D	EFR090
NISSAN	4400100Q0D	EFR092
NISSAN	4400100Q0J	EFR090
NISSAN	4400100Q0L	EFR092
NISSAN	4400100QAA	EFR014
NISSAN	4400100QAB	EFR014
NISSAN	4400100QAC	EFR018
NISSAN	440019X000	EFR100
NISSAN	44001MA000	522.9715.85
NISSAN	44001MA00A	522.9715.85
NISSAN	44001MB40A	522.7775.29
NISSAN	440109X103	527.5960.77
NISSAN	4401100Q0A	EFR017
NISSAN	4401100Q0C	EFR089
NISSAN	4401100Q0D	EFR091
NISSAN	4401100Q0E	EFR089
NISSAN	4401100Q0J	EFR089
NISSAN	4401100Q0K	EFR091
NISSAN	4401100Q0L	EFR089
NISSAN	4401100QAA	EFR013
NISSAN	4401100QAB	EFR013
NISSAN	4401100QAC	EFR017
NISSAN	440119X000	EFR101
NISSAN	44011MA000	522.9715.75
NISSAN	44011MA00A	522.9715.75
NISSAN	44011MB40A	522.7775.28
NISSAN	4406000Q0G	2517201
NISSAN	4406000Q0G	FVR4349
NISSAN	4406000Q0H	2511201
NISSAN	4406000Q0H	FVR4348
NISSAN	4406000Q0L	2511201
NISSAN	4406000Q0L	FVR4348
NISSAN	4406000Q0M	2517201
NISSAN	4406000Q0M	FVR4349
NISSAN	4406000Q1J	2511201
NISSAN	4406000Q1J	FVR4348
NISSAN	4406000Q1K	2517201
NISSAN	4406000Q1K	FVR4349
NISSAN	4406000Q2E	2398001
NISSAN	4406000Q2E	FVR1516
NISSAN	4406000QAE	2366901
NISSAN	4406000QAE	FVR1453
NISSAN	4406000QAF	2398001
NISSAN	4406000QAF	FVR1516
NISSAN	440606T390	2926101
NISSAN	440609X128	91059000

MARQUE/MAKER	REF/PN OES	REF/PN
NISSAN	440609X128	MP0558
NISSAN	440609X185	91059000
NISSAN	440609X185	MP0558
NISSAN	440629X125	KF6100
NISSAN	441009X125	CR0618
NISSAN	44100D6200	CR1004
NISSAN	4500098	92097700
NISSAN	4601000QAE	MC0415
NISSAN	4601000QAR	MC0415
NISSAN	464009X200	COR306
NISSAN	464009X50A	COR306
NISSAN	61002950	92174603
NISSAN	69029000	MF0353
NISSAN	69029120	PMN129
NISSAN	69029640	2903902
NISSAN	69029640	FCV702
NISSAN	69030120	CR1022
NISSAN	69041420	CR1022
NISSAN	69053200	MF0353
NISSAN	9320600QAA	08.9371.10
NISSAN	9320600QAA	92111203
NISSAN	9320600QAA	DDF1272C
NISSAN	AY040NS077	2926101
NISSAN	D10606T290	2926101
NISSAN	D10609X60B	2922902
NISSAN	D10609X60B	507.9703.16
NISSAN	D10609X60B	FVR4053
NISSAN	D10609X60C	2932701
NISSAN	D10609X60C	507.7304.25
NISSAN	D10609X60C	FVR4248
NISSAN	D1060LC44A	29122xx
NISSAN	D1060MB200	2922902
NISSAN	D1060MB200	507.9703.16
NISSAN	D1060MB200	FVR4053
NISSAN	D1060MB20C	2932701
NISSAN	D1060MB20C	FVR4248
NISSAN	D1060MB600	2922902
NISSAN	D1060MB600	507.9703.16
NISSAN	D1060MB600	FVR4053
NISSAN	D1060MB60A	2922902
NISSAN	D1060MB60A	507.9703.16
NISSAN	D1060MB60A	FVR4053
NISSAN	D40609X126	2912113
NISSAN	D40609X126	507.5944.54
NISSAN	D40609X126	FVR4156
NISSAN	D40609X60A	2912113
NISSAN	D40609X60A	507.5944.54
NISSAN	D40609X60A	FVR4156
NISSAN	D4060LC44A	2923103
NISSAN	D4060MA000	2392103
NISSAN	D4060MA000	507.8156.42
NISSAN	D4060MA000	FVR4054
NISSAN	D4060MB40A	2912113
NISSAN	D4060MB40A	2932701
NISSAN	D4060MB40A	FVR4156

Les correspondances de références ont pour seul but la recherche de références;

The cross references are intended only to seek references;

CORRESPONDANCE DES REFERENCES CROSS LIST

MARQUE/MAKER	REF/PN OES	REF/PN
NISSAN	D4060MB40A	FVR4248
NISSAN	D4060MB40B	91059000
NISSAN	D4060MB40B	MP0558
NISSAN	D4060MB40C	91059000
NISSAN	D4060MB40C	MP0558
NISSAN	D4120MA000	522.5000.27
NISSAN	D4220MA000	522.5000.27
OPEL	1605198	2309902
OPEL	1605198	FVR1515
OPEL	1605199	2398001
OPEL	1605199	FVR1516
OPEL	1605979	2330201
OPEL	1605979	FVR1292
OPEL	1605980	2361301
OPEL	1605980	FVR1452
OPEL	1605982	2366901
OPEL	1605982	FVR1453
OPEL	4400036	MC0415
OPEL	4402988	EFR009
OPEL	4402990	EFR010
OPEL	4402993	2361301
OPEL	4402993	FVR1452
OPEL	4403038	09.9080.10
OPEL	4403038	92115903
OPEL	4403038	DDF1217C-1
OPEL	4403045	08.9371.10
OPEL	4403045	92111203
OPEL	4403045	DDF1272C
OPEL	4403219	EFR172
OPEL	4403220	EFR173
OPEL	4403459	EFR013
OPEL	4403460	EFR014
OPEL	4403463	EFR014
OPEL	4403467	2366901
OPEL	4403467	FVR1453
OPEL	4404485	2361301
OPEL	4404485	FVR1452
OPEL	4404585	2361301
OPEL	4404585	FVR1452
OPEL	4404777	2330201
OPEL	4404777	FVR1292
OPEL	4405525	EFR011
OPEL	4405526	EFR012
OPEL	4405539	EFR013
OPEL	4405544	EFR014
OPEL	4406237	2511201
OPEL	4406237	FVR4348
OPEL	4406239	2517201
OPEL	4406239	FVR4349
OPEL	4408275	09.8937.10
OPEL	4408275	92116003
OPEL	4408275	DDF1204C-1
OPEL	4408276	08.9597.17
OPEL	4408276	92153703
OPEL	4408276	DDF1623-1

MARQUE/MAKER	REF/PN OES	REF/PN
OPEL	4411910	08.9597.17
OPEL	4411910	92153703
OPEL	4411910	DDF1623-1
OPEL	4413734	09.8937.10
OPEL	4413734	92116003
OPEL	4413734	DDF1204C-1
OPEL	4413736	08.9597.17
OPEL	4413736	92153703
OPEL	4413736	DDF1623-1
OPEL	4414021	2309902
OPEL	4414021	FVR1515
OPEL	4414022	EFR016
OPEL	4414023	EFR015
OPEL	4414026	EFR018
OPEL	4414027	EFR017
OPEL	4414029	2398001
OPEL	4414029	FVR1516
OPEL	4414519	2309902
OPEL	4414519	FVR1515
OPEL	4414520	2398001
OPEL	4414520	FVR1516
OPEL	4414622	EFR018
OPEL	4414622	EFR165
OPEL	4414623	EFR017
OPEL	4414623	EFR164
OPEL	4414632	09.8937.10
OPEL	4414632	92116003
OPEL	4414632	DDF1204C-1
OPEL	4414633	08.9597.17
OPEL	4414633	92153703
OPEL	4414633	DDF1623-1
OPEL	4415520	MC0415
OPEL	4418026	EFR015
OPEL	4418033	EFR016
OPEL	4418034	EFR017
OPEL	4418034	EFR164
OPEL	4418035	EFR018
OPEL	4418035	EFR165
OPEL	4419359	09.B633.10
OPEL	4419359	92228600
OPEL	4419359	DDF1974C-1
OPEL	4419362	08.B829.10
OPEL	4419362	92228700
OPEL	4419362	DDF1975C
OPEL	4419941	EFR087
OPEL	4419942	EFR088
OPEL	4419950	2514701
OPEL	4419950	FVR4347
OPEL	4420056	EFR089
OPEL	4420057	EFR090
OPEL	4420066	2511201
OPEL	4420066	FVR4348
OPEL	4421080	08.A651.10
OPEL	4421080	92228800
OPEL	4421080	DDF1976C

Les correspondances de références ont pour seul but la recherche de références;

The cross references are intended only to seek references;

CORRESPONDANCE DES REFERENCES CROSS LIST

MARQUE/MAKER	REF/PN OES	REF/PN
OPEL	4421180	08.A650.10
OPEL	4421180	92230800
OPEL	4421180	DDF1977C
OPEL	4421281	EFR091
OPEL	4421282	EFR090
OPEL	4421282	EFR092
OPEL	4421289	2517201
OPEL	4421289	FVR4349
OPEL	4422285	92268803
OPEL	4423332	2208701
OPEL	4423332	FVR4840
OPEL	4423333	2398001
OPEL	4423333	FVR1516
OPEL	4423587	2208701
OPEL	4423587	FVR4840
OPEL	4500098	09.7717.10
OPEL	4500098	92097700
OPEL	4500098	DDF1067C
OPEL	4501150	2330201
OPEL	4501150	FVR1292
OPEL	4501214	EFR007
OPEL	4501215	EFR008
OPEL	4501421	09.9080.10
OPEL	4501421	92115903
OPEL	4501421	DDF1217C-1
OPEL	4502797	2330201
OPEL	4502797	FVR1292
OPEL	4502801	EFR089
OPEL	4502802	EFR092
OPEL	4502805	EFR091
OPEL	4502882	2511201
OPEL	4502882	FVR4348
OPEL	4502883	2517201
OPEL	4502883	FVR4349
OPEL	4507797	2330201
OPEL	4507797	FVR1292
OPEL	542435	EFR090
OPEL	5542259	EFR013
OPEL	5542260	EFR014
OPEL	9108036	MC0415
OPEL	9110988	EFR009
OPEL	9110990	EFR010
OPEL	9110993	2361301
OPEL	9110993	FVR1452
OPEL	9111038	09.9080.10
OPEL	9111038	92115903
OPEL	9111038	DDF1217C-1
OPEL	9111045	08.9371.10
OPEL	9111045	92111203
OPEL	9111045	DDF1272C
OPEL	9111219	EFR172
OPEL	9111220	EFR173
OPEL	9111459	EFR013
OPEL	9111460	EFR014
OPEL	9111463	EFR014

MARQUE/MAKER	REF/PN OES	REF/PN
OPEL	9111467	2366901
OPEL	9111467	FVR1453
OPEL	9112585	2361301
OPEL	9112585	FVR1452
OPEL	9112777	2330201
OPEL	9112777	FVR1292
OPEL	91159915	09.8937.10
OPEL	91159915	92116003
OPEL	91159915	DDF1204C-1
OPEL	91159916	08.9597.17
OPEL	91159916	92153703
OPEL	91159916	DDF1623-1
OPEL	91165426	09.8937.10
OPEL	91165426	92116003
OPEL	91165426	DDF1204C-1
OPEL	91166212	08.9597.17
OPEL	91166212	92153703
OPEL	91166212	DDF1623-1
OPEL	9121358	EFR011
OPEL	9121359	EFR012
OPEL	9121372	EFR013
OPEL	9121377	EFR014
OPEL	9160398	09.7717.10
OPEL	9160398	92097700
OPEL	9160398	DDF1067C
OPEL	9161450	2330201
OPEL	9161450	FVR1292
OPEL	9161514	EFR007
OPEL	9161515	EFR008
OPEL	9161721	09.9080.10
OPEL	9161721	92115903
OPEL	9161721	DDF1217C-1
OPEL	9162600	2330201
OPEL	9162600	FVR1292
OPEL	9199254	EFR016
OPEL	9199255	EFR015
OPEL	9199257	2309902
OPEL	9199257	FVR1515
OPEL	9199259	EFR017
OPEL	9199260	EFR018
OPEL	9199262	2398001
OPEL	9199262	FVR1516
OPEL	93161253	09.8937.10
OPEL	93161253	92116003
OPEL	93161253	DDF1204C-1
OPEL	93161254	08.9597.17
OPEL	93161254	92153703
OPEL	93161254	DDF1623-1
OPEL	93167542	EFR087
OPEL	93167543	EFR087
OPEL	93167543	EFR088
OPEL	93167551	2514701
OPEL	93167551	FVR4347
OPEL	93167652	EFR089
OPEL	93167653	EFR090

Les correspondances de références ont pour seul but la recherche de références;

The cross references are intended only to seek references;

CORRESPONDANCE DES REFERENCES CROSS LIST

MARQUE/MAKER	REF/PN OES	REF/PN
OPEL	93167662	2511201
OPEL	93167662	FVR4348
OPEL	93168847	08.A651.10
OPEL	93168847	92228800
OPEL	93168847	DDF1976C
OPEL	93168942	08.A650.10
OPEL	93168942	92230800
OPEL	93168942	DDF1977C
OPEL	93169542	EFR087
OPEL	93169543	EFR088
OPEL	93173155	2330201
OPEL	93173155	FVR1292
OPEL	93173180	2361301
OPEL	93173180	FVR1452
OPEL	93173182	2366901
OPEL	93173182	FVR1453
OPEL	93173311	EFR013
OPEL	93173313	EFR014
OPEL	93173641	2309902
OPEL	93173641	FVR1515
OPEL	93173646	2398001
OPEL	93173646	FVR1516
OPEL	93174804	EFR018
OPEL	93174804	EFR165
OPEL	93174805	EFR017
OPEL	93174805	EFR164
OPEL	93181416	MC0415
OPEL	93192058	EFR015
OPEL	93192059	EFR016
OPEL	93192063	2309902
OPEL	93192063	FVR1515
OPEL	93192386	EFR017
OPEL	93192386	EFR164
OPEL	93192387	EFR018
OPEL	93192387	EFR165
OPEL	93192389	2398001
OPEL	93192389	FVR1516
OPEL	93197403	09.B633.10
OPEL	93197403	92228600
OPEL	93197403	DDF1974C-1
OPEL	93197406	08.B829.10
OPEL	93197406	92228700
OPEL	93197406	DDF1975C
OPEL	93850649	08.9597.17
OPEL	93850649	92153703
OPEL	93850649	DDF1623-1
OPEL	93866700	92268803
OPEL	95507101	EFR091
OPEL	95507102	EFR090
OPEL	95507102	EFR092
OPEL	95507110	2517201
OPEL	95507110	FVR4349
OPEL	95513821	2511201
OPEL	95513821	FVR4348
OPEL	95513823	2517201

MARQUE/MAKER	REF/PN OES	REF/PN
OPEL	95513823	FVR4349
OPEL	95515197	2366901
OPEL	95515197	FVR1453
OPEL	95518304	2208701
OPEL	95518304	FVR4840
OPEL	95518305	2398001
OPEL	95518305	FVR1516
OPEL	95518893	2208701
OPEL	95518893	FVR4840
OPEL	95519997	EFR089
OPEL	95520001	EFR089
OPEL	95520451	EFR089
OPEL	95520452	EFR092
OPEL	95520912	EFR090
OPEL	95520918	EFR091
OPEL	95521679	2511201
OPEL	95521679	FVR4348
OPEL	95521680	2517201
OPEL	95521680	FVR4349
OPEL	95522278	2514701
OPEL	95522278	FVR4347
OPEL	95522645	EFR087
OPEL	95544647	EFR088
OPEL	95599218	2361301
OPEL	95599218	FVR1452
OPEL	95599219	2309902
OPEL	95599219	FVR1515
OPEL	95599224	2398001
OPEL	95599224	FVR1516
PERROT	12999235VT	2901602
PERROT	40244009	EFR051
PERROT	40244010	EFR052
PERROT	40244017	EFR128
PERROT	40244018	EFR129
PERROT	40444149	EFR047
PERROT	40444150	EFR048
PERROT	40444183	EFR049
PERROT	40444184	EFR050
PERROT	40444191	EFR043
PERROT	40444192	EFR044
PERROT	40444205	EFR043
PERROT	40444206	EFR044
PERROT	40444223	EFR043
PERROT	40444224	EFR044
PERROT	40450013	EFR046
PERROT	40450014	EFR045
PERROT	40456033	EFR039
PERROT	40456034	EFR040
PERROT	40465019	EFR041
PERROT	40465020	EFR042
PEUGEOT	1606400980	09.8931.20
PEUGEOT	1606400980	92275103
PEUGEOT	1606400980	DDF1170C
PEUGEOT	1606401680	09.8932.10
PEUGEOT	1606401680	92116703

Les correspondances de références ont pour seul but la recherche de références;

The cross references are intended only to seek references;

CORRESPONDANCE DES REFERENCES CROSS LIST

MARQUE/MAKER	REF/PN OES	REF/PN
PEUGEOT	1606401680	DDF768C
PEUGEOT	1607872080	09.8931.20
PEUGEOT	1607872080	92275103
PEUGEOT	1607872080	DDF1170C
PEUGEOT	1607872280	09.8932.10
PEUGEOT	1607872280	92116703
PEUGEOT	1607872280	DDF768C
PEUGEOT	1607880480	08.8094.30
PEUGEOT	1607880480	92116103
PEUGEOT	1607880480	DDF1144C
PEUGEOT	1607880580	08.8094.40
PEUGEOT	1607880580	92116203
PEUGEOT	1607880580	DDF1145
PEUGEOT	1611457780	2392101
PEUGEOT	1611457780	FVR1480
PEUGEOT	4241N5	91066700
PEUGEOT	424669	08.3056.10
PEUGEOT	424685	08.4478.10
PEUGEOT	424693	08.9601.14
PEUGEOT	424695	08.9601.14
PEUGEOT	424696	08.4478.10
PEUGEOT	4246A0	08.3136.14
PEUGEOT	4246B3	08.4478.10
PEUGEOT	4246B4	08.9601.14
PEUGEOT	4246B8	08.3056.10
PEUGEOT	4246H3	08.3136.14
PEUGEOT	4246J8	08.9604.14
PEUGEOT	4246J9	08.5905.14
PEUGEOT	4246K2	09.8932.10
PEUGEOT	4246K2	09.9615.14
PEUGEOT	4246K2	92116703
PEUGEOT	4246K2	DDF768C
PEUGEOT	4246K3	09.5906.14
PEUGEOT	4246K3	09.8932.10
PEUGEOT	4246K3	92116703
PEUGEOT	4246K3	DDF768C
PEUGEOT	4246L2	09.8931.20
PEUGEOT	4246L2	09.9614.14
PEUGEOT	4246L2	92275103
PEUGEOT	4246L2	DDF1170C
PEUGEOT	4246L3	09.5904.14
PEUGEOT	4246L4	09.5904.14
PEUGEOT	4246L4	09.8931.20
PEUGEOT	4246L4	92275103
PEUGEOT	4246L4	DDF1170C
PEUGEOT	4246N5	08.3069.14
PEUGEOT	4246N7	08.3136.14
PEUGEOT	4246X9	09.8931.20
PEUGEOT	4246X9	92275103
PEUGEOT	4246X9	DDF1170C
PEUGEOT	4246Y1	09.8931.20
PEUGEOT	4246Y1	92275103
PEUGEOT	4246Y1	DDF1170C
PEUGEOT	4246Y3	09.8932.10
PEUGEOT	4246Y3	92116703

MARQUE/MAKER	REF/PN OES	REF/PN
PEUGEOT	4246Y3	DDF768C
PEUGEOT	4246Y5	09.8932.10
PEUGEOT	4246Y5	92116703
PEUGEOT	4246Y5	DDF768C
PEUGEOT	4246Y9	08.8094.30
PEUGEOT	4246Y9	92116103
PEUGEOT	4246Y9	DDF1144C
PEUGEOT	4246Z3	08.8094.40
PEUGEOT	4246Z3	92116203
PEUGEOT	4246Z3	DDF1145
PEUGEOT	424900	09.8931.20
PEUGEOT	424900	92275103
PEUGEOT	424900	DDF1170C
PEUGEOT	4249000	09.8932.10
PEUGEOT	4249000	92116703
PEUGEOT	4249000	DDF768C
PEUGEOT	424926	09.8931.20
PEUGEOT	424926	92275103
PEUGEOT	424926	DDF1170C
PEUGEOT	424935	09.8932.10
PEUGEOT	424935	92116703
PEUGEOT	424935	DDF768C
PEUGEOT	424936	09.8932.10
PEUGEOT	424936	92116703
PEUGEOT	424936	DDF768C
PEUGEOT	424999	09.8931.20
PEUGEOT	424999	92275103
PEUGEOT	424999	DDF1170C
PEUGEOT	4249A0	09.8932.10
PEUGEOT	4249A0	92116703
PEUGEOT	4249A0	DDF768C
PEUGEOT	4249G3	09.8931.20
PEUGEOT	4249G3	92275103
PEUGEOT	4249G3	DDF1170C
PEUGEOT	4249G4	08.8094.30
PEUGEOT	4249G4	92116103
PEUGEOT	4249G4	DDF1144C
PEUGEOT	4249G5	09.8932.10
PEUGEOT	4249G5	92116703
PEUGEOT	4249G5	DDF768C
PEUGEOT	4249G6	08.8094.40
PEUGEOT	4249G6	92116203
PEUGEOT	4249G6	DDF1145
PEUGEOT	4249H2	09.8932.10
PEUGEOT	4249H2	92116703
PEUGEOT	4249H2	DDF768C
PEUGEOT	4249H8	09.8931.20
PEUGEOT	4249H8	92275103
PEUGEOT	4249H8	DDF1170C
PEUGEOT	4249H9	09.8932.10
PEUGEOT	4249H9	92116703
PEUGEOT	4249H9	DDF768C
PEUGEOT	4249K3	09.8931.20
PEUGEOT	4249K3	92275103
PEUGEOT	4249K3	DDF1170C

Les correspondances de références ont pour seul but la recherche de références;

The cross references are intended only to seek references;

CORRESPONDANCE DES REFERENCES CROSS LIST

MARQUE/MAKER	REF/PN OES	REF/PN
PEUGEOT	425074	2078401
PEUGEOT	425074	FVR239
PEUGEOT	425242	2391701
PEUGEOT	425242	FVR1478
PEUGEOT	425243	2391701
PEUGEOT	425243	FVR1478
PEUGEOT	425244	2391901
PEUGEOT	425244	FVR1479
PEUGEOT	425245	2391901
PEUGEOT	425245	FVR1479
PEUGEOT	425246	2392101
PEUGEOT	425246	FVR1480
PEUGEOT	425247	2392101
PEUGEOT	425247	FVR1480
PEUGEOT	425458	2391701
PEUGEOT	425458	FVR1478
PEUGEOT	425459	2391901
PEUGEOT	425459	FVR1479
PEUGEOT	425468	2392101
PEUGEOT	425468	FVR1480
PEUGEOT	440085	EFR148
PEUGEOT	440086	EFR149
PEUGEOT	440157	EFR098
PEUGEOT	440158	EFR099
PEUGEOT	440159	EFR098
PEUGEOT	440160	EFR099
PEUGEOT	4401F0	522.8148.46
PEUGEOT	4401F1	522.8148.56
PEUGEOT	4401G6	522.8148.46
PEUGEOT	4401G7	522.8148.56
PEUGEOT	4401H6	522.8142.32
PEUGEOT	4401H6	522.8142.45
PEUGEOT	4401H7	522.8142.42
PEUGEOT	4401H7	522.8142.55
PEUGEOT	4401L4	522.8153.12
PEUGEOT	4401L5	522.8153.22
PEUGEOT	4401L8	522.8142.46
PEUGEOT	4401L9	522.8142.56
PEUGEOT	4401N0	522.8148.45
PEUGEOT	4401N1	522.8148.55
PEUGEOT	4401N2	522.8148.46
PEUGEOT	4401N3	522.8148.56
PEUGEOT	453583	MC0110
PEUGEOT	46806233	09.8931.20
PEUGEOT	46806233	92275103
PEUGEOT	46806233	DDF1170C
PEUGEOT	46806234	09.8932.10
PEUGEOT	46806234	92116703
PEUGEOT	46806234	DDF768C
PEUGEOT	4949H2	09.8932.10
PEUGEOT	4949H2	92116703
PEUGEOT	4949H2	DDF768C
PEUGEOT	51728378	09.8932.10
PEUGEOT	51728378	92116703
PEUGEOT	51728378	DDF768C

MARQUE/MAKER	REF/PN OES	REF/PN
PIAGGIO	76007423	MC0626
PUCH	0014201420	2078401
PUCH	0014201420	FVR239
PUCH	6014208720	2078401
PUCH	6014208720	FVR239
RENAULT	402066352R	92268803
RENAULT	410014614R	EFR012
RENAULT	410015070R	EFR088
RENAULT	410015708R	EFR088
RENAULT	410110092R	EFR087
RENAULT	410111997R	EFR087
RENAULT	410118977R	EFR011
RENAULT	410601061R	2514701
RENAULT	410601061R	FVR4347
RENAULT	410601073R	2208701
RENAULT	410601073R	FVR4840
RENAULT	410604386R	2514701
RENAULT	410604386R	FVR4347
RENAULT	410608638R	2208701
RENAULT	410608638R	FVR4840
RENAULT	432000367R	08.B829.10
RENAULT	432000367R	92228700
RENAULT	432000367R	DDF1975C
RENAULT	432064087R	08.A651.10
RENAULT	432064087R	92228800
RENAULT	432064087R	DDF1976C
RENAULT	432067943R	08.A650.10
RENAULT	432067943R	92230800
RENAULT	432067943R	DDF1977C
RENAULT	440010724R	EFR090
RENAULT	440010724R	EFR092
RENAULT	440010814R	EFR090
RENAULT	440011819R	EFR090
RENAULT	440011819R	EFR092
RENAULT	440013212R	EFR092
RENAULT	440013425R	EFR090
RENAULT	440014373R	EFR090
RENAULT	440016059R	EFR090
RENAULT	440016929R	EFR092
RENAULT	440107553R	EFR091
RENAULT	440111516R	EFR089
RENAULT	440114638R	EFR089
RENAULT	440114849R	EFR091
RENAULT	440115485R	EFR089
RENAULT	440115651R	EFR091
RENAULT	440116884R	EFR091
RENAULT	440118711R	EFR089
RENAULT	440600264R	2511201
RENAULT	440600264R	FVR4348
RENAULT	440600866R	2517201
RENAULT	440600866R	FVR4349
RENAULT	440600941R	2517201
RENAULT	440600941R	FVR4349
RENAULT	440601147R	2511201
RENAULT	440601147R	FVR4348

Les correspondances de références ont pour seul but la recherche de références;

The cross references are intended only to seek references;

CORRESPONDANCE DES REFERENCES CROSS LIST

MARQUE/MAKER	REF/PN OES	REF/PN
RENAULT	440601186R	2511201
RENAULT	440601186R	FVR4348
RENAULT	440602070R	2511201
RENAULT	440602070R	FVR4348
RENAULT	440607091R	2398001
RENAULT	440607091R	FVR1516
RENAULT	440608697R	2517201
RENAULT	440608697R	FVR4349
RENAULT	5000295329	2907102
RENAULT	5000295329	FVR627
RENAULT	5000815574	2907102
RENAULT	5000815574	FVR627
RENAULT	6025371277	EFR015
RENAULT	6025371278	EFR016
RENAULT	7001207196	2330201
RENAULT	7001207196	FVR1292
RENAULT	7700302128	09.7717.10
RENAULT	7700302128	92097700
RENAULT	7700302128	DDF1067C
RENAULT	7700314064	09.9080.10
RENAULT	7700314064	92115903
RENAULT	7700314064	DDF1217C-1
RENAULT	7700314107	08.9371.10
RENAULT	7700314107	92111203
RENAULT	7700314107	DDF1272C
RENAULT	7700561367	09.3357.10
RENAULT	7700821375	2907102
RENAULT	7700821375	FVR627
RENAULT	7701001747	CR0310
RENAULT	7701050914	2309902
RENAULT	7701050914	FVR1515
RENAULT	7701050915	EFR017
RENAULT	7701050916	EFR018
RENAULT	7701050918	2398001
RENAULT	7701050918	FVR1516
RENAULT	7701050919	EFR015
RENAULT	7701050920	EFR016
RENAULT	7701051808	EFR016
RENAULT	7701054771	2309902
RENAULT	7701054771	FVR1515
RENAULT	7701054772	2398001
RENAULT	7701054772	FVR1516
RENAULT	7701056165	EFR018
RENAULT	7701056165	EFR165
RENAULT	7701056166	EFR017
RENAULT	7701056166	EFR164
RENAULT	7701202038	EFR172
RENAULT	7701202039	EFR173
RENAULT	7701203700	2907102
RENAULT	7701203700	FVR627
RENAULT	7701204281	09.3357.10
RENAULT	7701205286	MC0415
RENAULT	7701205294	2330201
RENAULT	7701205294	FVR1292
RENAULT	7701205763	EFR007

MARQUE/MAKER	REF/PN OES	REF/PN
RENAULT	7701205764	EFR008
RENAULT	7701206369	2330201
RENAULT	7701206369	FVR1292
RENAULT	7701206725	EFR009
RENAULT	7701206726	EFR010
RENAULT	7701206727	2361301
RENAULT	7701206727	FVR1452
RENAULT	7701206754	EFR013
RENAULT	7701206755	EFR014
RENAULT	7701206763	2366901
RENAULT	7701206763	FVR1453
RENAULT	7701206845	09.8937.10
RENAULT	7701206845	92116003
RENAULT	7701206845	DDF1204C-1
RENAULT	7701206846	08.9597.17
RENAULT	7701206846	92153703
RENAULT	7701206846	DDF1623-1
RENAULT	7701207166	2330201
RENAULT	7701207166	FVR1292
RENAULT	7701207339	2361301
RENAULT	7701207339	FVR1452
RENAULT	7701208012	EFR007
RENAULT	7701208012	EFR011
RENAULT	7701208013	EFR012
RENAULT	7701208036	EFR013
RENAULT	7701208037	EFR014
RENAULT	7701208175	SV0001
RENAULT	7701208176	MC0415
RENAULT	7701260845	09.8937.10
RENAULT	7701260845	92116003
RENAULT	7701260845	DDF1204C-1
RENAULT	7701365115	CRB157
RENAULT	7701499319	EFR140
RENAULT	7701499320	EFR141
RENAULT	7702206846	08.9597.17
RENAULT	7702206846	92153703
RENAULT	7702206846	DDF1623-1
RENAULT	7711130076	08.9597.17
RENAULT	7711130076	92153703
RENAULT	7711130076	DDF1623-1
RENAULT	7711130077	09.8937.10
RENAULT	7711130077	92116003
RENAULT	7711130077	DDF1204C-1
RENAULT	7711134470	EFR172
RENAULT	7711134473	EFR173
RENAULT	7711135669	EFR017
RENAULT	7711135700	EFR018
RENAULT	7711135701	EFR015
RENAULT	7711135702	EFR016
RENAULT	7711135703	EFR018
RENAULT	7711135703	EFR165
RENAULT	7711135704	EFR017
RENAULT	7711135704	EFR164
RENAULT	7711368826	EFR013
RENAULT	7711368827	EFR014

Les correspondances de références ont pour seul but la recherche de références;

The cross references are intended only to seek references;

CORRESPONDANCE DES REFERENCES CROSS LIST

MARQUE/MAKER	REF/PN OES	REF/PN
RENAULT	8200050013	08.9597.17
RENAULT	8200050013	92153703
RENAULT	8200050013	DDF1623-1
RENAULT	8200218779	08.9597.17
RENAULT	8200218779	92153703
RENAULT	8200218779	DDF1623-1
RENAULT	8200228610	08.9597.17
RENAULT	8200228610	92153703
RENAULT	8200228610	DDF1623-1
RENAULT	8200688880	09.B633.10
RENAULT	8200688880	92228600
RENAULT	8200688880	DDF1974C-1
RENAULT	8252901	EFR015
RENAULT	8252902	EFR016
RENAULT	8472238	EFR015
RENAULT	8472239	EFR016
RENAULT	8671005954	2309902
RENAULT	8671005954	FVR1515
RENAULT	8671016180	2309902
RENAULT	8671016180	FVR1515
RENAULT	8671016186	2361301
RENAULT	8671016186	FVR1452
RENAULT	8671016747	2366901
RENAULT	8671016747	FVR1453
RENAULT TRUCKS	0770507400	CR0367
RENAULT TRUCKS	0770507500	CR0366
RENAULT TRUCKS	0855755600	MC0187
RENAULT TRUCKS	0855755700	MC0188
RENAULT TRUCKS	0870090900	CR0366
RENAULT TRUCKS	0870441200	CR0342
RENAULT TRUCKS	0870441300	CR0351
RENAULT TRUCKS	0870507400	CR0367
RENAULT TRUCKS	0870618400	CRB190
RENAULT TRUCKS	3328017	CR0529
RENAULT TRUCKS	440016929R	EFR092
RENAULT TRUCKS	5000001165	CRB143
RENAULT TRUCKS	5000001166	CRB144
RENAULT TRUCKS	5000001169	CRB147
RENAULT TRUCKS	5000242586	CR0549
RENAULT TRUCKS	5000242587	CR0550
RENAULT TRUCKS	5000243040	CR0539
RENAULT TRUCKS	5000243144	CR0546
RENAULT TRUCKS	5000297808	2901302
RENAULT TRUCKS	5000297808	FCV668
RENAULT TRUCKS	5000388057	09.4481.10
RENAULT TRUCKS	5000392589	MC0585
RENAULT TRUCKS	5000393657	CR0827
RENAULT TRUCKS	5000396548	CFM003
RENAULT TRUCKS	5000396612	DF713809
RENAULT TRUCKS	5000396855	TF6806
RENAULT TRUCKS	5000450158	09.6732.20
RENAULT TRUCKS	5000450158	93085900
RENAULT TRUCKS	5000450158	FCR126A
RENAULT TRUCKS	5000514566	MC0381
RENAULT TRUCKS	5000516025	CR0690

MARQUE/MAKER	REF/PN OES	REF/PN
RENAULT TRUCKS	5000545242	09.6732.20
RENAULT TRUCKS	5000545242	93085900
RENAULT TRUCKS	5000545242	FCR126A
RENAULT TRUCKS	5000545848	EFR001
RENAULT TRUCKS	5000545849	EFR002
RENAULT TRUCKS	5000559107	CR0928
RENAULT TRUCKS	5000559108	CR0929
RENAULT TRUCKS	5000559150	CR0932
RENAULT TRUCKS	5000559151	CR0933
RENAULT TRUCKS	5000559194	CR0925
RENAULT TRUCKS	5000559194	CR0936
RENAULT TRUCKS	5000559197	CR0926
RENAULT TRUCKS	5000559197	CR0937
RENAULT TRUCKS	5000559398	MC0391
RENAULT TRUCKS	5000560980	CR0940
RENAULT TRUCKS	5000560981	CR0941
RENAULT TRUCKS	5000790539	09.7956.10
RENAULT TRUCKS	5000790539	93086200
RENAULT TRUCKS	5000790539	FCR128A
RENAULT TRUCKS	5000807463	EFR005
RENAULT TRUCKS	5000807464	EFR006
RENAULT TRUCKS	5000813673	2901302
RENAULT TRUCKS	5000813673	FCV668
RENAULT TRUCKS	5000814699	CR0891
RENAULT TRUCKS	5000815370	CR0918
RENAULT TRUCKS	5000815514	CR0896
RENAULT TRUCKS	5000815603	CR0925
RENAULT TRUCKS	5000815604	CR0926
RENAULT TRUCKS	5000815639	2901302
RENAULT TRUCKS	5000815639	FCV668
RENAULT TRUCKS	5000816602	CR0934
RENAULT TRUCKS	5000816603	CR0935
RENAULT TRUCKS	5000816604	CR0930
RENAULT TRUCKS	5000816605	CR0931
RENAULT TRUCKS	5000821995	2901302
RENAULT TRUCKS	5000821995	FCV668
RENAULT TRUCKS	5000823412	2901302
RENAULT TRUCKS	5000823412	FCV668
RENAULT TRUCKS	5000823566	2907102
RENAULT TRUCKS	5000823566	FVR627
RENAULT TRUCKS	5000890960	COR386
RENAULT TRUCKS	5000987156	CR0837
RENAULT TRUCKS	5000987157	CR0838
RENAULT TRUCKS	5000987158	CR0835
RENAULT TRUCKS	5000987159	CR0836
RENAULT TRUCKS	5001001409	EFR140
RENAULT TRUCKS	5001001410	EFR141
RENAULT TRUCKS	5001014667	MC0626
RENAULT TRUCKS	5001014694	2906504
RENAULT TRUCKS	5001014694	FCV879
RENAULT TRUCKS	5001014704	2906705
RENAULT TRUCKS	5001014704	507.5664.31
RENAULT TRUCKS	5001014704	FCV733
RENAULT TRUCKS	5001821995	2901302
RENAULT TRUCKS	5001821995	FCV668

Les correspondances de références ont pour seul but la recherche de références;

The cross references are intended only to seek references;



CORRESPONDANCE DES REFERENCES CROSS LIST

MARQUE/MAKER	REF/PN OES	REF/PN
RENAULT TRUCKS	5001825638	2906504
RENAULT TRUCKS	5001825638	FCV879
RENAULT TRUCKS	5001825639	2906705
RENAULT TRUCKS	5001825639	507.5664.31
RENAULT TRUCKS	5001825639	FCV733
RENAULT TRUCKS	5001825775	EFR001
RENAULT TRUCKS	5001825777	EFR002
RENAULT TRUCKS	5001829350	MF0601
RENAULT TRUCKS	5001829545	2909702
RENAULT TRUCKS	5001829545	FCV1046
RENAULT TRUCKS	5001834076	EFR005
RENAULT TRUCKS	5001834077	EFR006
RENAULT TRUCKS	5001834527	2907102
RENAULT TRUCKS	5001834527	FVR627
RENAULT TRUCKS	5001844747	2912111
RENAULT TRUCKS	5001844747	507.5944.32
RENAULT TRUCKS	5001844747	FVR1315
RENAULT TRUCKS	5001844748	2916002
RENAULT TRUCKS	5001844748	2916004
RENAULT TRUCKS	5001844748	507.7304.18
RENAULT TRUCKS	5001844748	FVR1390
RENAULT TRUCKS	5001844749	91059000
RENAULT TRUCKS	5001844749	MP0558
RENAULT TRUCKS	5001847577	MC0235
RENAULT TRUCKS	5001848129	522.7301.73
RENAULT TRUCKS	5001848130	522.7301.83
RENAULT TRUCKS	5001850859	2912111
RENAULT TRUCKS	5001850859	507.5944.32
RENAULT TRUCKS	5001850859	FVR1315
RENAULT TRUCKS	5001856069	522.7773.73
RENAULT TRUCKS	5001856070	522.7773.83
RENAULT TRUCKS	5001856071	522.7775.73
RENAULT TRUCKS	5001856072	522.7775.83
RENAULT TRUCKS	5001860144	91059000
RENAULT TRUCKS	5001860144	MP0558
RENAULT TRUCKS	5001864479	EFR037
RENAULT TRUCKS	5001864480	EFR038
RENAULT TRUCKS	5001864712	HBK2001
RENAULT TRUCKS	5001865097	CR0930
RENAULT TRUCKS	5001865098	CR0931
RENAULT TRUCKS	5001865103	CR0549
RENAULT TRUCKS	5001865104	CR0550
RENAULT TRUCKS	5001865106	CR0896
RENAULT TRUCKS	5001865108	MC0391
RENAULT TRUCKS	5001865109	CR0918
RENAULT TRUCKS	5001865110	MC0187
RENAULT TRUCKS	5001865111	CR0827
RENAULT TRUCKS	5001865113	CR0539
RENAULT TRUCKS	5001865114	CR0546
RENAULT TRUCKS	5001865115	MC0585
RENAULT TRUCKS	5001865118	CR0891
RENAULT TRUCKS	5001865119	CR0690
RENAULT TRUCKS	5001865120	CRB190
RENAULT TRUCKS	5001865123	CR0367
RENAULT TRUCKS	5001865124	CRB157

MARQUE/MAKER	REF/PN OES	REF/PN
RENAULT TRUCKS	5001866728	EFR005
RENAULT TRUCKS	5001866729	EFR006
RENAULT TRUCKS	5001866730	EFR005
RENAULT TRUCKS	5001866731	EFR006
RENAULT TRUCKS	5001866959	CR0925
RENAULT TRUCKS	5001866960	CR0926
RENAULT TRUCKS	5001866961	CR0934
RENAULT TRUCKS	5001866962	CR0935
RENAULT TRUCKS	5001867100	MF0601
RENAULT TRUCKS	5001867381	522.7775.73
RENAULT TRUCKS	5001867382	522.7775.83
RENAULT TRUCKS	5001867383	522.7306.28
RENAULT TRUCKS	5001867384	522.7306.29
RENAULT TRUCKS	5001867385	522.7301.73
RENAULT TRUCKS	5001867386	522.7301.83
RENAULT TRUCKS	5001867417	KF6001
RENAULT TRUCKS	5001867455	522.7773.73
RENAULT TRUCKS	5001867456	522.7773.83
RENAULT TRUCKS	5001867459	522.7775.73
RENAULT TRUCKS	5001867460	522.7775.83
RENAULT TRUCKS	5001867468	522.7301.73
RENAULT TRUCKS	5001867469	522.7301.83
RENAULT TRUCKS	5001868606	2922902
RENAULT TRUCKS	5001868606	507.9703.16
RENAULT TRUCKS	5001868606	FVR4053
RENAULT TRUCKS	5001868608	2392103
RENAULT TRUCKS	5001868608	507.8156.42
RENAULT TRUCKS	5001868608	FVR4054
RENAULT TRUCKS	5001868609	2912113
RENAULT TRUCKS	5001868609	507.5944.54
RENAULT TRUCKS	5001868609	FVR4156
RENAULT TRUCKS	5001871213	09.B410.10
RENAULT TRUCKS	5001871213	FCR326A
RENAULT TRUCKS	5001871214	09.8965.10
RENAULT TRUCKS	5001871214	93240600
RENAULT TRUCKS	5001871214	FCR339A
RENAULT TRUCKS	5001871281	08.9794.60
RENAULT TRUCKS	5001871281	FCR369A
RENAULT TRUCKS	5001871282	09.7263.30
RENAULT TRUCKS	5001871282	FCR340A
RENAULT TRUCKS	5001872513	522.9715.75
RENAULT TRUCKS	5001872515	522.9715.85
RENAULT TRUCKS	5001873218	2906705
RENAULT TRUCKS	5001873218	507.5664.31
RENAULT TRUCKS	5001873218	FCV733
RENAULT TRUCKS	5001874362	522.7773.73
RENAULT TRUCKS	5001874363	522.7773.83
RENAULT TRUCKS	5001874364	522.7775.73
RENAULT TRUCKS	5001874365	522.7775.83
RENAULT TRUCKS	5001874366	522.7301.73
RENAULT TRUCKS	5001874367	522.7301.83
RENAULT TRUCKS	5001874368	522.7306.28
RENAULT TRUCKS	5001874369	522.7306.29
RENAULT TRUCKS	5001874635	08.9794.10
RENAULT TRUCKS	5001874635	FCR327A

Les correspondances de références ont pour seul but la recherche de références;

The cross references are intended only to seek references;

CORRESPONDANCE DES REFERENCES CROSS LIST

MARQUE/MAKER	REF/PN OES	REF/PN
RENAULT TRUCKS	5001874888	2932701
RENAULT TRUCKS	5001874888	FVR4248
RENAULT TRUCKS	5001875373	09.9080.10
RENAULT TRUCKS	5001875373	92115903
RENAULT TRUCKS	5001875373	DDF1217C-1
RENAULT TRUCKS	5001875375	08.9371.10
RENAULT TRUCKS	5001875375	92111203
RENAULT TRUCKS	5001875375	DDF1272C
RENAULT TRUCKS	5010046458	CR0835
RENAULT TRUCKS	5010046459	CR0836
RENAULT TRUCKS	5010046460	CR0837
RENAULT TRUCKS	5010046461	CR0838
RENAULT TRUCKS	5010098100	EFR035
RENAULT TRUCKS	5010098101	EFR036
RENAULT TRUCKS	5010098109	EFR037
RENAULT TRUCKS	5010098110	EFR038
RENAULT TRUCKS	5010197252	EFR004
RENAULT TRUCKS	5010197253	EFR003
RENAULT TRUCKS	5010216433	09.6734.20
RENAULT TRUCKS	5010216433	93085800
RENAULT TRUCKS	5010216433	FCR169A
RENAULT TRUCKS	5010260603	09.7261.10
RENAULT TRUCKS	5010260603	93117500
RENAULT TRUCKS	5010260603	FCR182A
RENAULT TRUCKS	5010260604	09.7262.10
RENAULT TRUCKS	5010260604	93117400
RENAULT TRUCKS	5010260604	FCR183A
RENAULT TRUCKS	5010260609	09.7263.20
RENAULT TRUCKS	5010260609	93117600
RENAULT TRUCKS	5010260609	FCR184A
RENAULT TRUCKS	5010319684	KB0001
RENAULT TRUCKS	5010361653	CFM004
RENAULT TRUCKS	5010597252	EFR004
RENAULT TRUCKS	5010597253	EFR003
RENAULT TRUCKS	5010598645	522.7773.73
RENAULT TRUCKS	5010598646	522.7773.83
RENAULT TRUCKS	5010598651	522.7306.28
RENAULT TRUCKS	5010598652	522.7306.29
RENAULT TRUCKS	6024371662	2309902
RENAULT TRUCKS	6024371662	FVR1515
RENAULT TRUCKS	6025371279	2309902
RENAULT TRUCKS	6025371279	FVR1515
RENAULT TRUCKS	7410604386	2514701
RENAULT TRUCKS	7410604386	FVR4347
RENAULT TRUCKS	7420851342	CR0835
RENAULT TRUCKS	7420851343	CR0836
RENAULT TRUCKS	7420851344	CR0837
RENAULT TRUCKS	7420851349	COR386
RENAULT TRUCKS	7420929456	CFM001
RENAULT TRUCKS	7420929457	CFM002
RENAULT TRUCKS	7440600866	2517201
RENAULT TRUCKS	7440600866	FVR4349
RENAULT TRUCKS	7440601147	2511201
RENAULT TRUCKS	7440601147	FVR4348
RENAULT TRUCKS	7485013071	522.9715.85

MARQUE/MAKER	REF/PN OES	REF/PN
RENAULT TRUCKS	7485013072	522.9715.75
RENAULT TRUCKS	7485013075	522.9700.76
RENAULT TRUCKS	7485013076	522.9700.86
RENAULT TRUCKS	7485114857	2998501
RENAULT TRUCKS	7485116333	2922902
RENAULT TRUCKS	7485116333	507.9703.16
RENAULT TRUCKS	7485116333	FVR4053
RENAULT TRUCKS	7485119636	522.7301.83
RENAULT TRUCKS	7485119637	522.7301.73
RENAULT TRUCKS	7485120000	522.9715.85
RENAULT TRUCKS	7485120001	522.9715.75
RENAULT TRUCKS	7485120221	2932701
RENAULT TRUCKS	7485120221	507.7304.25
RENAULT TRUCKS	7485120221	FVR4248
RENAULT TRUCKS	7485120325	522.7775.73
RENAULT TRUCKS	7485120328	522.7775.83
RENAULT TRUCKS	7485120668	08.B829.10
RENAULT TRUCKS	7485120668	92228700
RENAULT TRUCKS	7485120668	DDF1975C
RENAULT TRUCKS	7485121181	2392103
RENAULT TRUCKS	7485121181	FVR4054
RENAULT TRUCKS	7485121661	522.9700.76
RENAULT TRUCKS	7485121662	522.9700.86
RENAULT TRUCKS	7485121748	2514701
RENAULT TRUCKS	7485121748	FVR4347
RENAULT TRUCKS	7485121752	2511201
RENAULT TRUCKS	7485121752	FVR4348
RENAULT TRUCKS	7485121975	EFR088
RENAULT TRUCKS	7485121976	EFR087
RENAULT TRUCKS	7485122116	EFR090
RENAULT TRUCKS	7485122117	EFR089
RENAULT TRUCKS	7485123974	08.A651.10
RENAULT TRUCKS	7485123974	92228800
RENAULT TRUCKS	7485123974	DDF1976C
RENAULT TRUCKS	7485124209	08.A650.10
RENAULT TRUCKS	7485124209	92230800
RENAULT TRUCKS	7485124209	DDF1977C
RENAULT TRUCKS	7485124347	EFR091
RENAULT TRUCKS	7485124349	EFR092
RENAULT TRUCKS	7485124350	2517201
RENAULT TRUCKS	7485124350	FVR4349
RENAULT TRUCKS	7485133241	2511201
RENAULT TRUCKS	7485133241	FVR4348
RENAULT TRUCKS	7485133244	2517201
RENAULT TRUCKS	7485135103	EFR092
RENAULT TRUCKS	7485136294	EFR089
RENAULT TRUCKS	7485146736	EFR089
RENAULT TRUCKS	7485146744	EFR090
RENAULT TRUCKS	7485146820	2511201
RENAULT TRUCKS	7485146824	EFR090
RENAULT TRUCKS	7485147324	2514701
RENAULT TRUCKS	7485147324	FVR4347
RENAULT TRUCKS	7485147327	2511201
RENAULT TRUCKS	7485147733	2517201
RENAULT TRUCKS	7485147733	FVR4349

Les correspondances de références ont pour seul but la recherche de références;

The cross references are intended only to seek references;

CORRESPONDANCE DES REFERENCES CROSS LIST

MARQUE/MAKER	REF/PN OES	REF/PN
RENAULT TRUCKS	7485147739	EFR092
RENAULT TRUCKS	7485147740	EFR091
RENAULT TRUCKS	7485147742	EFR092
RENAULT TRUCKS	7485147817	EFR091
RENAULT TRUCKS	8200010519	09.8937.10
RENAULT TRUCKS	8200010519	92116003
RENAULT TRUCKS	8200010519	DDF1204C-1
RENAULT TRUCKS	8200227715	09.8937.10
RENAULT TRUCKS	8200227715	92116003
RENAULT TRUCKS	8200227715	DDF1204C-1
RENAULT TRUCKS	8200228610	92153703
RENAULT TRUCKS	8200688880	09.B633.10
RENAULT TRUCKS	8200688880	92228600
RENAULT TRUCKS	8200688880	DDF1974C-1
RENAULT TRUCKS	8200735266	EFR087
RENAULT TRUCKS	8200735269	EFR088
RENAULT TRUCKS	8200735277	EFR090
RENAULT TRUCKS	8200735279	EFR091
RENAULT TRUCKS	8200735280	EFR092
SETRA	351773	2968801
SETRA	351906	2968801
SETRA	82840002070	2968801
TOYOTA	446536020	2929601
TOYOTA	446536070	2929601
TOYOTA	446537010	2929601
TOYOTA	446537030	2929601
TOYOTA	446537100	2929601
TOYOTA	446537150	2929601
TOYOTA	446537250	2929601
TOYOTA	449136070	2929601
VOLKSWAGEN	211615107A	EFR146
VOLKSWAGEN	211615108A	EFR147
VOLKSWAGEN	211615301B	08.2536.10
VOLKSWAGEN	251407615B	08.5396.10
VOLKSWAGEN	251407615J	08.5501.10
VOLKSWAGEN	251407615Q	08.5396.10
VOLKSWAGEN	251407615R	08.5501.10
VOLKSWAGEN	251407617A	08.2981.10
VOLKSWAGEN	251407617D	08.5177.10
VOLKSWAGEN	251407617G	08.5177.20
VOLKSWAGEN	251407617K	08.5177.10
VOLKSWAGEN	251407617M	08.5177.20
VOLKSWAGEN	251611021C	MC0619
VOLKSWAGEN	251611021D	MC0619
VOLKSWAGEN	251611021E	MC0619
VOLKSWAGEN	251615107	EFR146
VOLKSWAGEN	251615107A	EFR146
VOLKSWAGEN	251615108	EFR147
VOLKSWAGEN	251615108A	EFR147
VOLKSWAGEN	281615107	EFR138
VOLKSWAGEN	281615107B	EFR138
VOLKSWAGEN	281615283	08.3295.10
VOLKSWAGEN	281615283A	08.2982.10
VOLKSWAGEN	281615283J	08.2982.10
VOLKSWAGEN	291615107	EFR136

MARQUE/MAKER	REF/PN OES	REF/PN
VOLKSWAGEN	291615107B	EFR124
VOLKSWAGEN	291615108	EFR137
VOLKSWAGEN	291615108	EFR139
VOLKSWAGEN	291615108B	EFR125
VOLKSWAGEN	291615108B	EFR139
VOLKSWAGEN	291698151	2078401
VOLKSWAGEN	291698151	FVR239
VOLKSWAGEN	291698151A	2078401
VOLKSWAGEN	291698151A	FVR239
VOLKSWAGEN	2D0501215A	KB0001
VOLKSWAGEN	2D0609538A	91057900
VOLKSWAGEN	2D0609538A	MP0594
VOLKSWAGEN	2D0611019	MC0308
VOLKSWAGEN	2D0611019A	MC0093
VOLKSWAGEN	2D0611019A	MC0308
VOLKSWAGEN	2D0611019C	MC0093
VOLKSWAGEN	2D0611019C	MC0308
VOLKSWAGEN	2D0611019D	MC0473
VOLKSWAGEN	2D0615105A	EFR051
VOLKSWAGEN	2D0615105B	EFR051
VOLKSWAGEN	2D0615106A	EFR052
VOLKSWAGEN	2D0615106B	EFR052
VOLKSWAGEN	2D0615123A	EFR095
VOLKSWAGEN	2D0615124A	EFR096
VOLKSWAGEN	2D0615301A	09.7314.14
VOLKSWAGEN	2D0615301A	92131503
VOLKSWAGEN	2D0615301B	09.7314.24
VOLKSWAGEN	2D0615423	EFR170
VOLKSWAGEN	2D0615423A	EFR174
VOLKSWAGEN	2D0615423C	EFR126
VOLKSWAGEN	2D0615424	EFR171
VOLKSWAGEN	2D0615424A	EFR175
VOLKSWAGEN	2D0615424C	EFR127
VOLKSWAGEN	2D0615601	08.7724.10
VOLKSWAGEN	2D0615601A	08.7725.10
VOLKSWAGEN	2D0615601A	92137603
VOLKSWAGEN	2D0615601B	09.8475.10
VOLKSWAGEN	2D0615601B	92089803
VOLKSWAGEN	2D0615601B	FCR191A
VOLKSWAGEN	2D0615601C	08.7724.20
VOLKSWAGEN	2D0615601C	92137503
VOLKSWAGEN	2D0615601C	FCR230A
VOLKSWAGEN	2D0615601D	08.7725.20
VOLKSWAGEN	2D0615601D	92137603
VOLKSWAGEN	2D0615601D	FCR229A
VOLKSWAGEN	2D0615601E	09.8475.10
VOLKSWAGEN	2D0615601E	92089803
VOLKSWAGEN	2D0615601E	FCR191A
VOLKSWAGEN	2D0698151	2399002
VOLKSWAGEN	2D0698151	FVR1038
VOLKSWAGEN	2D0698151A	2915301
VOLKSWAGEN	2D0698151A	FVR1879
VOLKSWAGEN	2D0698151B	2915301
VOLKSWAGEN	2D0698151B	FVR1879
VOLKSWAGEN	2D0698151C	2399002

Les correspondances de références ont pour seul but la recherche de références;

The cross references are intended only to seek references;

CORRESPONDANCE DES REFERENCES CROSS LIST

MARQUE/MAKER	REF/PN OES	REF/PN
VOLKSWAGEN	2D0698151C	FVR1038
VOLKSWAGEN	2D0698451	2390101
VOLKSWAGEN	2D0698451A	2473901
VOLKSWAGEN	2D0698451A	FVR1039
VOLKSWAGEN	2D0698451B	2302101
VOLKSWAGEN	2D0698451C	2473901
VOLKSWAGEN	2D0698451C	FVR1039
VOLKSWAGEN	2D0698451D	2473901
VOLKSWAGEN	2D0698451D	FVR1039
VOLKSWAGEN	2D0698525	91055100
VOLKSWAGEN	2D0698525	MP0574
VOLKSWAGEN	2D0698525A	91057900
VOLKSWAGEN	2D0698525A	MP0594
VOLKSWAGEN	2D0698525B	91055100
VOLKSWAGEN	2D0698525B	MP0574
VOLKSWAGEN	2D0919351	98018200
VOLKSWAGEN	2D0919351A	98031700
VOLKSWAGEN	2E0609701AA	CFM015
VOLKSWAGEN	2E0609701J	CFM012
VOLKSWAGEN	2E0609701T	CFM013
VOLKSWAGEN	2E0615101	EFR065
VOLKSWAGEN	2E0615101A	EFR077
VOLKSWAGEN	2E0615101F	EFR065
VOLKSWAGEN	2E0615102	EFR066
VOLKSWAGEN	2E0615102A	EFR078
VOLKSWAGEN	2E0615102F	EFR066
VOLKSWAGEN	2E0615105A	EFR077
VOLKSWAGEN	2E0615105B	EFR065
VOLKSWAGEN	2E0615105C	EFR077
VOLKSWAGEN	2E0615106A	EFR078
VOLKSWAGEN	2E0615106B	EFR066
VOLKSWAGEN	2E0615106C	EFR078
VOLKSWAGEN	2E0615301	09.9508.14
VOLKSWAGEN	2E0615301	93143200
VOLKSWAGEN	2E0615301	FCR310A
VOLKSWAGEN	2E0615405B	EFR073
VOLKSWAGEN	2E0615406B	EFR074
VOLKSWAGEN	2E0615423	EFR073
VOLKSWAGEN	2E0615423A	EFR075
VOLKSWAGEN	2E0615424	EFR074
VOLKSWAGEN	2E0615424A	EFR076
VOLKSWAGEN	2E0615601	09.9510.14
VOLKSWAGEN	2E0615601	93143403
VOLKSWAGEN	2E0615601	FCR312A
VOLKSWAGEN	2E0615601A	08.9509.14
VOLKSWAGEN	2E0615601A	93143300
VOLKSWAGEN	2E0615601A	FCR311A
VOLKSWAGEN	2E0698151	2919202
VOLKSWAGEN	2E0698151	FVR1778
VOLKSWAGEN	2E0698151A	2920002
VOLKSWAGEN	2E0698151A	FVR1777
VOLKSWAGEN	2E0698151B	2919202
VOLKSWAGEN	2E0698151B	FVR1778
VOLKSWAGEN	2E0698151C	2920002
VOLKSWAGEN	2E0698151C	FVR1777

MARQUE/MAKER	REF/PN OES	REF/PN
VOLKSWAGEN	2E0698151E	2919202
VOLKSWAGEN	2E0698151E	FVR1778
VOLKSWAGEN	2E0698151F	2920002
VOLKSWAGEN	2E0698151F	FVR1777
VOLKSWAGEN	2E0698451	2919001
VOLKSWAGEN	2E0698451	FVR1780
VOLKSWAGEN	2E0698451A	2921702
VOLKSWAGEN	2E0698451A	FVR1779
VOLKSWAGEN	2E0698451A	FVR4429
VOLKSWAGEN	2E0698451B	2921702
VOLKSWAGEN	2E0698451B	FVR1779
VOLKSWAGEN	2E0698451B	FVR4429
VOLKSWAGEN	2E0698525	91066800
VOLKSWAGEN	2E0698525	MP0655
VOLKSWAGEN	2E0698525A	91069000
VOLKSWAGEN	2E0698525A	MP0678SA
VOLKSWAGEN	2E0698525D	91069000
VOLKSWAGEN	2E0698525D	MP0678SA
VOLKSWAGEN	2E0906206A	98033700
VOLKSWAGEN	2E0906206B	98036500
VOLKSWAGEN	2E0906206C	98033700
VOLKSWAGEN	2E0906206G	98033800
VOLKSWAGEN	701615301	08.5497.10
VOLKSWAGEN	701615301	08.7288.14
VOLKSWAGEN	701615301A	08.7288.14
VOLKSWAGEN	701615301A	09.5566.10
VOLKSWAGEN	701615301B	08.5768.10
VOLKSWAGEN	701615301C	08.5497.10
VOLKSWAGEN	701615301D	09.5566.10
VOLKSWAGEN	701615301E	08.5768.10
VOLKSWAGEN	701615301F	09.7131.14
VOLKSWAGEN	701615301G	08.7132.10
VOLKSWAGEN	7D0615601A	08.9176.10
VOLKSWAGEN	7D0615601D	08.9176.10
VOLKSWAGEN	7H0615423	EFR168
VOLKSWAGEN	7H0615423A	EFR168
VOLKSWAGEN	7H0615424	EFR169
VOLKSWAGEN	7H0615424A	EFR169
VOLKSWAGEN	8E0698151E	2920002
VOLKSWAGEN	8E0698151E	FVR1777
VOLKSWAGEN	JZW698151AB	2919202
VOLKSWAGEN	JZW698151AB	FVR1778
VOLVO	1517824	CR0932
VOLVO	1517825	CR0933
VOLVO	1517834	CR0925
VOLVO	1517834	CR0936
VOLVO	1517834-6	CR0925
VOLVO	1517835	CR0926
VOLVO	1517835	CR0937
VOLVO	1517835-3	CR0926
VOLVO	1517941	CR0928
VOLVO	1517942	CR0929
VOLVO	1517952	CR0940
VOLVO	1517953	CR0941
VOLVO	1697450	EFR019

Les correspondances de références ont pour seul but la recherche de références;

The cross references are intended only to seek references;

TRADUCTION / TRANSLATION

Français	Anglais	Allemand	Italien	Espagnol
Câbles et tirettes à câble de frein	Brake cables and cable controls	Bremsseile	Funi comando freno	Latiguillos de freno
Capteur de roue	Wheel sensor	Radsensor	seniore ruota	seniore de rueda
Correcteur de freinage	Brake pressure regulator	Bremskraftregler	correttore di frenata	corrector de frenado
Correcteur de freinage	Regulator	Regler	correttore di frenata	regulador
Correcteurs de Freinage Suspension Mécanique	Load Sensing Valves Mechanical Suspension	Bremskraftregler mechanisch	Correttori di Frenata Meccanici	Correctores de frenado Suspensión Mecánica
Correcteurs de Freinage Suspension Pneumatique	Load Sensing Valves Air Suspension	Bremskraftregler, pneumatisch	Correttori di Frenata Pneumatici	Correctores de frenado Suspensión neumática
Cylindre hydraulique	Hydraulic cylinder	Hydraulikzylinder	cilindro idraulico	cilindro de hidráulico
Cylindres de roues	Wheel brake cylinders	Bremszylinder	Cilindret	Cilindros de frenos
Disque plein	Solid disc	Massive Bremsscheibe	Disco pieno	Disco macizo
Disque ventilé	Ventilated disc	belüftete Bremsscheibe	Disco ventilato	Disco ventilado
Disques de frein	Brake discs	Scheibenbremse	Dischi freno	Discos de freno
Étrier à 1 piston	Single-piston caliper	1-Kolbensattel	pinza freno a un pistoncino	mordaza de freno
Étrier à 2 pistons	2-piston caliper	2-Kolbensattel	pinza freno a 2 pistoncini	mordaza con dos pistones
Étrier à 4 pistons	4-piston caliper	4-Kolbensattel	pinza freno a 4 pistoncini	mordaza con 4 pistones
Étrier avec 1 bouchon d'arrêt	Caliper with 1 retaining pin	Sattel mit 1 Haltestift	pinza con una spina di fissaggio	pinza con 1 pasador
Étrier avec 2 bouchon d'arrêt	Caliper with 2 retaining pins	Sattel mit 2 Haltestiften	pinza con due spine di fissaggio	pinza con 2 pasadores
Étrier de frein	Caliper	Bremssattel	Pinza per freno a disco	Pinza de freno
Étrier de frein à disque	Disk brake callipers	Bremszangen und -sättel	Pinze per freni a disco	Pinzas y zapatas de freno
Étrier flottant	Floating caliper	Schwimmsattel	pinza freno flottante	pinza flotante
Étriers en aluminium	Alu-calipers	Alu-Sättel	pinza in alluminio	mordaza de freno de aluminio
Étriers en fonte grise	Cast iron-caliper	GG-Sättel	pinza in ghisa	pinza de fundición de gris
Étriers fixes	Fixed caliper	Festsattel	pinza freno fissa	pinza de fija
Étriers frein à 1 circuit	Single-circuit caliper	1-Kreis-Sättel	pinza freno a 1 circuito	pinza de 1 circuito
Étriers frein à 2 circuits	Two-circuit-caliper	2-Kreis-Sättel	pinza freno a 2 circuiti	pinza de 2 circuitos
Fil témoin d'usure	Wear indicator cable	Kabel für Verschleissanzeiger	Cavetto indicatore d'usura	Cable del indicador de desgaste
Maître cylindre	Master cylinder	Hauptzylinder	pompa freno	Cilindro maestro
Maître cylindre tandem	Tandem master cylinder	Tandemhauptzylinder	pompa freno tandem	Cilindro tandem
Plaquettes de frein	Disc brake pads	Scheibenbremsbeläge, Bremsklötze	Pastiglie per freni a disco, Pastiglie freno	Pastillas de freno de disco
Mâchoires de frein à tambour	Drum brake shoes	Trommelbremsbacken	Ganasce freno	Zapatas de freno

**GIL Automotive remet à jour la documentation sur le site
GIL Automotive will update the documentation on the site**

www.GiL-Automotive.com

Avis de non-responsabilité

Les marques désignées sont des marques déposées par leurs propriétaires respectifs. GIL Automotive n'est en aucun cas liée, affiliée ou associée aux propriétaires de ces marques. Les produits de GIL Automotive présentés dans ce document ne sont ni recommandés ni autorisés par les propriétaires de ces marques.

Disclaimer

The designated trademarks are registered marks of their respective owners and GIL Automotive is not commercially connected, affiliated, or associated with any of the owners of such marks. The GIL Automotive products presented herein are not endorsed or authorized by any of the trademark owners.

Cachet du distributeur / Distributor stamp

